

Daniels Manufacturing Corporation offers our BETA Backshell Assembly Tools, a complete line of Adaptor Tools and Torque Tools for holding and torquing circular connectors during the installation and removal of accessories (backshell, strain relief, or EMI/RFI shielding hardware).

With 60 years of industry experience, DMC is the leading manufacturer of Mil-Qualified Crimp Termination Tools, Maintenance Tool Kits, and Insertion/Removal Tools for the High-Reliability Wire Harness Industry. DMC also manufactures ALPHATRON Wire Crimp Pull Testers and SAFE-T-CABLE, the time-saving substitute for safety Lockwire. DMC products have been used on virtually every Defense System, Aircraft Program, Land or Sea Going Transport System, and Space Exploration Program.

DMC is continually working with the government and major manufacturers towards the development of support materials to keep pace with the most recent advances in technology. DMC is ready and capable to help satisfy your tooling needs with custom engineered tools.

DMC's full-service facility in Orlando, Florida has a qualified staff to recalibrate tools to meet FAA requirements and to refurbish Adaptor Tool Kits. DMC has developed a worldwide network of professionals who can assist in answering technical questions, processing orders for complete kits and individual components, and designing new service kits and modifying existing kits.

DMC is an ISO 9100:2000 and AS9100:2004 Registered Company, and ROHS Compliant.



CONTENTS

Adaptor Tools Introduction	2
BETA System Utilization	4
Connector Technical Data Pages & Adaptor Tool Selection Guide	6
Connector Identification	23
Connector Mate Assembly Vise	28
Torque Tools	30
Strap Wrenches	32
Torque Conversion Formula	36
Torque Conversion Charts	37
General Purpose Backshell/ Accessory Tools	37
Jam Nut Sockets	38
Circular Ring Pliers	41
EMI/RFI Banding Tools	42
BETA Tool Kits	46
Connector Accessory Guide	48
Suggested Torque Values	53
Other DMC Products	54
National Stock Numbers for Beta Series Tooling	55
Warranty	56

IMPORTANT NOTICE

The tooling suggested herein may not cover a user's specific contract or manufacturing requirements. It is the user's responsibility to carry out sufficient testing to verify the suitability of the DMC product selected for the specific requirements of each particular application. DMC is not liable for consequential or special damages of any nature or kind resulting from the use of any of our products.

Verbally quoted prices, or any prices, appearing in printed price lists, are subject to change without prior notice.

If you need firm prices for future deliveries, you should request a written quotation from our sales office.

**LIMITED WARRANTY
SEE INSIDE BACK COVER**

ADAPTOR TOOLS



The central element of the Daniels Manufacturing Corp. Beta connector accessory tool product line is the adaptor tool. This unique device is configured in such a manner as to mate perfectly with the corresponding circular connector keying pattern. Therefore, it can be used to hold the connector in a stationary position while the accessory components are being installed or removed. Many keying arrangements and shell sizes are utilized in high reliability wiring systems and great care must be exercised when selecting and using the Beta adaptor tool. DMC has made great efforts to combine the most possible applications into each adaptor tool design, thereby mini-

mizing the tool requirements for overall system support. Many other important benefits are designed into DMC Beta adaptor tools.

SINGLE TOOL FOR MULTIPLE KEYING POSITIONS

When multiple keying positions exist within a specific shell size (Diameter), DMC engineers have designed each adaptor tool to accommodate as many variations as possible. Most adaptors will mate with six or more connectors having different keying positions. When compared with dummy receptacles or other connector holding devices, this flexibility is not possible.

MULTIPLE KEY ENGAGEMENT

The critical platings and delicate nature of connector keys are a prime consideration in the design of a secure connector holding system. Therefore, in all cases where the basic connector configuration permits, multiple key engagement is utilized. This allows torque to be applied to a greater

surface area and over a larger portion of the circumference of the connector.

ADAPTORS ARE AVAILABLE FOR BOTH PLUGS AND RECEPTACLES

The rotating coupling mechanism found on most plug connectors is the primary factor which prompted the original adaptor tool design; however, many users currently realize the benefits of adaptor tools when assembling or servicing receptacle connectors. DMC has both versions available for most circular connector series.

STANDARD SQUARE DRIVE MOUNTING

All DMC adaptor tools are made with a standard square drive (either 3/8" or 1/4") socket for easy utilization with common torque measuring devices or other tooling. This eliminates the need for special mounting fixtures, or other considerations common to the use of dummy receptacles and similar equipment.

CIRCULAR CONNECTORS AND THEIR ACCESSORIES

The evolution of electrical connectors has seen many changes in design configuration and utilization of many varieties of materials to meet the needs of their intended application. Backshells, strain reliefs, and other connector accessories have been a vital factor in that enduring evolutionary process.

Most connector manufacturers and suppliers offer a limited variety of connector accessories. But, the specific needs of aerospace designers has fostered a connector accessory industry comprised of many dynamic manufacturers, with extensive product lines dedicated solely to components which extend the connector's

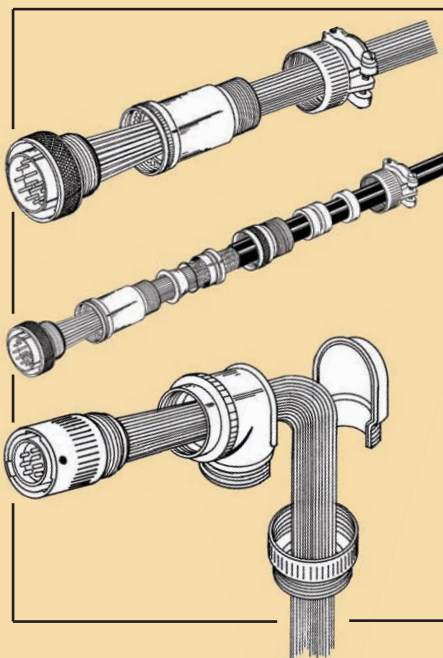

performance capabilities. This variety of products offers the equipment designer total flexibility in the packaging of electronic wiring systems.

In the past two decades special considerations such as the shielding of electrical circuits from interference generated by radar systems, communication equipment, electrical fields, nuclear fields and harsh environmental conditions, have required accessory suppliers to develop multi-piece components which have very specific assembly and maintenance requirements. The demand for advanced tool capabilities is a critical element in the utilization of these sophisticated backshell systems.

QUICK REFERENCE TOOLING GUIDE

CONNECTOR IDENTIFICATION	ADAPTOR TOOL SETS		ADAPTOR LABEL	PAGE
	PLUG	RECEPTACLE		
AS50151	CM-S-5015	CM-S-5015R	CHROME	6
MIL-DTL-22992 CLASS C,J,R	CM-S-229	N/A	BROWN	7
MIL-DTL-22992 CLASS L	CM-S-229L	N/A	BLACK	8
MIL-DTL-26482 SERIES I & II	CM-S-264	CM-S-264R	ORANGE	9
MIL-DTL-26500	CM-S-837	CM-S-837RB*	GREEN	10
MIL-DTL-28840	CM-S-288	CM-S-288R	WHITE	11
MIL-DTL-38999 SERIES I	CM-S-389L	CM-S-389LR	BLUE	12
MIL-DTL-38999 SERIES II	CM-S-389S	CM-S-264R	GRAY/ ORANGE	13
MIL-DTL-38999 SERIES III	CM-S-389T	CM-S-389TR	LAVENDER	14
MIL-DTL-38999 SERIES IV	CM-S-389B	CM-S-389BR	BEIGE	15
MIL-C-81511 SERIES I & III	CM-S-815L	CM-S-815R	YELLOW	16
MIL-C-81511 SERIES I & IV	CM-S-815S	CM-S-815R	RED	17
MIL-DTL-83723 SERIES I	CM-S-264	CM-S-264R	ORANGE	18
MIL-DTL-83723 SERIES II	CM-S-5015	CM-S-5015R	CHROME	19
MIL-DTL-83723 SERIES III	CM-S-837	CM-S-837RB*	GREEN	20
PATTERN 602	CM-S-602	CM-S-264R	PURPLE	21
PATTERN 615	CM-S-SJT	CM-S-264R	GOLD	22

SIMPLE ORIENTATION TO THE CONNECTOR

All adaptor tools have an indicator (Dot) which visually orients it with the master key on the connector. This enables the user to orient the two components for mating without trial and error fumbling.

ECONOMICAL, RELIABLE, AND AVAILABLE

There is not a precision system for holding circular connectors available anywhere which is more economical, reliable, or readily available to meet your needs than the DMC Beta adaptor tools.

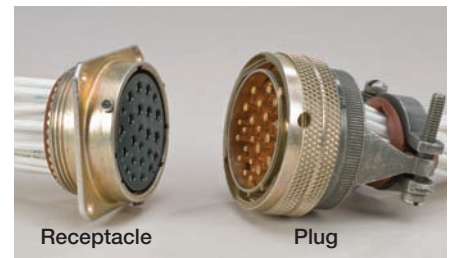

Typical Mated Pair Connectors

*BAYONET COUPLINGS ONLY – THREADED RECEPTACLE SETS ARE NOT AVAILABLE

N/A – Not available at time of printing. Consult factory.



BETA SYSTEM UTILIZATION

ADAPTOR TOOL COMPATIBILITY WITH OTHER BETA SYSTEM PRODUCTS

Adaptor tools and other accessory tools which comprise the DMC Beta™ product line are used in a variety of combinations to afford the user an efficient and flexible system of connector/accessory assembly. The following illustrations depict a few of the products which are combined in use. Certainly there are many applications which are not described. The selection of tools and the ways in which they are used are both dependent upon the types of connectors and accessory components as well as production and quality considerations. DMC will help with any application questions you may have.

NOTE: Rotating the connector is not recommended — due to the stress which it imposes on the wire, contacts and sealing components. Adaptors and their associated tools that are designed to hold the connector stationary while the backshell accessory is turned.



SIMPLE HAND TIGHTENING

In the most basic operation, the adaptor is mated with the connector, and held in one hand. This stabilizes the connector while the backshell accessory is tightened with the other hand.

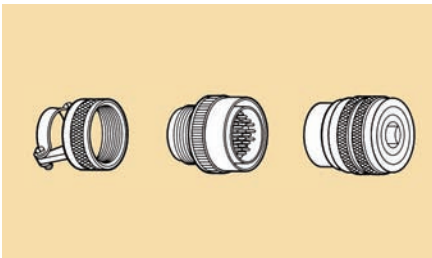

Strain relief, connector, adaptor



Strain relief, connector, adaptor

SIMPLE MECHANICAL ASSIST

When mechanical assistance is necessary to sufficiently tighten the accessory onto the connector, the stabilizing effect of the adaptor can be reinforced with one of several tools — in the operation shown, the connector is held stationary by the use of a “T” handle in the drive hole of the adaptor, while soft jaw pliers are being used on the accessory.

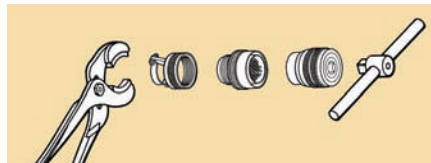

Soft jaw pliers, strain relief, connector, adaptor, T-handle



Soft jaw pliers, strain relief, connector, adaptor, T-handle

Other tools, such as circular ring pliers or a strap wrench, could also have been selected to add simple mechanical assistance.



Circular Ring Pliers, strain relief, connector, adaptor, T-handle



Strap wrench, strain relief, connector

PRODUCTION STATION APPLICATIONS

When the measurement of torque is a requirement of a particular cable assembly operation, this can be easily accomplished with the use of the digital torque wrench.



Digital torque wrench, adaptor, connector, strain relief



Digital torque wrench, handle-less strap wrench, connector, strain relief

If a static torque meter is needed, the digital torque wrench can be placed in a static mount base. The adaptor is then attached to the square drive on the torque meter, and this arrangement holds the connector while the backshell accessory is torqued onto the connector, with a strap wrench.

When the torque reaches the pre-set value, a signal light advises the operator that the desired torque value has been applied.

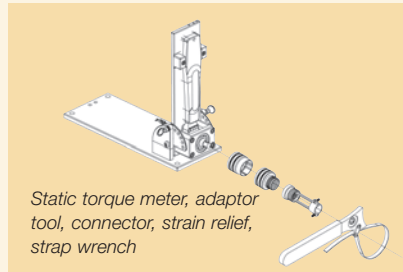

Static torque meter, adaptor tool, connector, strain relief, strap wrench

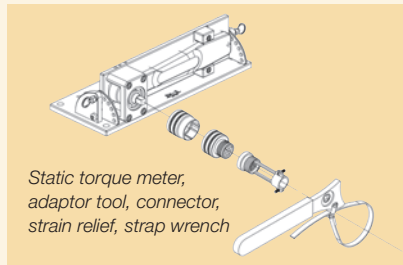

Static torque meter, adaptor tool, connector, strain relief, strap wrench

When optimum repeatability and production efficiency demand, the assembly station vise can be used to complement the ability of adaptor tools to stabilize the connector. As shown, the vise is being used to firmly hold the adaptor tool, while a strap wrench is being used to tighten the backshell onto the connector.

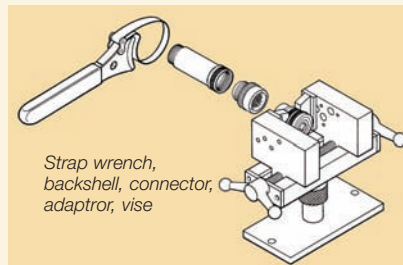

Strap wrench, backshell, connector, adaptor, vise

On multi-piece backshells, the correct torque on each accessory can only be achieved by efficiently holding adjacent parts. In the example shown, the assembly station vise is being used to hold the backshell segment already torqued onto the connector, while the strain relief is tightened with a strap wrench and a torque meter. Thus, the correct torque can be applied to the backshell segments without affecting the torque value already applied to prior connector/ accessory components.

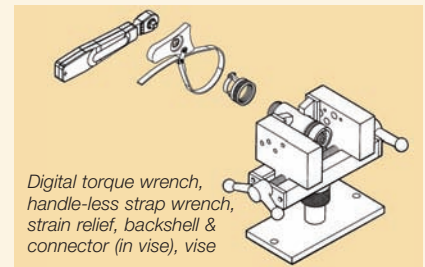

Digital torque wrench, handle-less strap wrench, strain relief, backshell & connector (in vise), vise

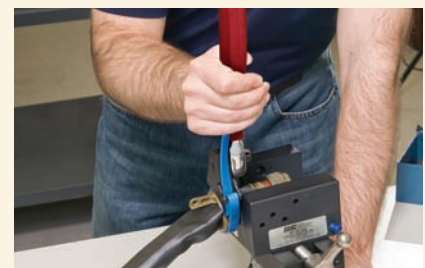

Handle-less strap wrench, digital torque wrench, strain relief, backshell (in vise jaws), connector, vise

AS50151 SERIES MS3100, MS3400 & MS3450

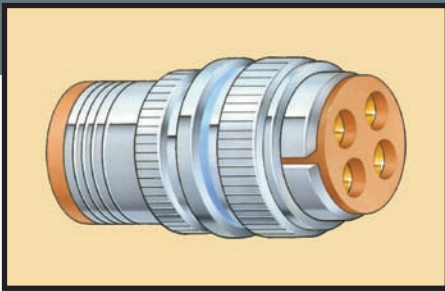

Straight Plug Shown

MANUFACTURER:

AERO ELECTRIC
AMPHENOL
BENDIX

BURNDY
CONNECTOR INDUSTRIES
DETORONICS
ELECTRONIC SEALS
FLIGHT CONNECTOR
GLASSEAL
HERMETIC SEAL CORP.
ITT CANNON

MATRIX SCIENCE
IPI (SAE)
SEALTRON
VEAM/LITTON

SERIES:

AE55, AE723
69, 72, 97, 157, 172, 173, 179, 208, 238 246
BT-M, BT-RA, HT, SCP, TBF, 10-72, 10-214, 10-244, 10-741,
10-747, 10-873, 10-874, 5015
LM°C
A
DS
5015
FC, FH, FF0, FF5, FZC, FZH
GSP
HS06, S*A-2000, 2000
BFH, BFR, CA, CA-EA, CA-EB, CA-HR, CA-KE, CA-RX, CV,
CVA, EX-A, FRA, FRF, FVA, FVF, FW, GS, MR, TBF, TBFH, WFS
MFR, M723, 944, 981
M0, M5, SA
6000, 8000
VE, VS, VTBF, 10/71, 75

SPECIFICATIONS:

COUPLING METHOD: THREADED (MS3107,
MS3507 QUICK
DISCONNECT)
KEYING POSITIONS: BLANK (NORMAL),
W, X, Y, Z
**ALTERNATE KEYING
METHOD:** ROTATION OF INSERT
WITHIN SHELL – KEY
REMAINS STATIONARY
EMI/RFI GROUNDING: NO

SHELL MATERIAL & FINISH:

SHELL	FINISH
ALUMINUM	Cadmium Olive Drab Nickel Cadmium Olive Drab Over Nickel
WROUGHT ALUMINUM	Cadmium Olive Drab Over Nickel
STEEL	Cadmium Olive Drab Nickel
STAINLESS STEEL	Cadmium Black Passivated

**TYPICAL CONNECTOR
PART NUMBER
BREAKDOWN**

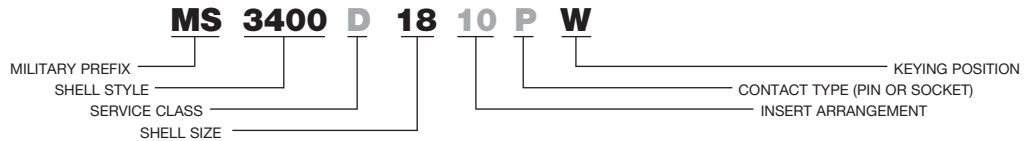

ADAPTOR TOOLS

PLUG (REMOVABLE PORTION)					RECEPTACLE (STATIONARY PORTION)				
BASIC IDENT. #/DESCRIPTION	SHELL SIZE	KEYING POSITIONS	ADAPTOR TOOL NUMBER	COLOR	BASIC IDENT. #/DESCRIPTION	SHELL SIZE	KEYING POSITIONS	ADAPTOR TOOL NUMBER	COLOR
MS3106 /Straight	8	ALL	CM5015-8	CHROME	MS3100 /Wall mount	8	ALL	CM5015R-8	CHROME
MS3107 /Quick disconnect	10	ALL	CM5015-10	CHROME	MS3101 /In-line	10	ALL	CM5015R-10	CHROME
MS3108 /90° angle	12	ALL	CM5015-12	CHROME	MS3102 /Box mount	12	ALL	CM5015R-12	CHROME
MS3436 /Straight	14	ALL	CM5015-14	CHROME	MS3103 /Wall mount, potting seal	14	ALL	CM5015R-14	CHROME
MS3507 /Quick disconnect	16	ALL	CM5015-16	CHROME	MS3142 /Box mount, hermetic seal	16	ALL	CM5015R-16	CHROME
MS25183 /Straight, potting seal	18	ALL	CM5015-18	CHROME	MS3143 /Solder mount, hermetic seal	18	ALL	CM5015R-18	CHROME
MS25183A /Straight, potting seal, with ground lug	20	ALL	CM5015-20	CHROME	MS3400 /Wall mount	20	ALL	CM5015R-20	CHROME
MS3406 /Straight	22	ALL	CM5015-22	CHROME	MS3401 /In-line	22	ALL	CM5015R-22	CHROME
MS3408 /90° angle	24	ALL	CM5015-24	CHROME	MS3402 /Box mount	24	ALL	CM5015R-24	CHROME
MS3409 /45° angle	28	ALL	CM5015-28	CHROME	MS3404 */Jam nut	28	ALL	CM5015R-28	CHROME
MS3456 /Straight	32	ALL	CM5015-32	CHROME	MS3412 /Box mount, threaded rear skirt	32	ALL	CM5015R-32	CHROME
MS3459 /Straight self-locking coupling nut	36	ALL	CM5015-36	CHROME	MS3450 /Wall mount	36	ALL	CM5015R-36	CHROME
	40	ALL	CM5015-40	CHROME	MS3451 /In-line	40	ALL	CM5015R-40	CHROME
	44	ALL	CM5015-44	CHROME	MS3452 /Box mount	44	ALL	CM5015R-44	CHROME
	48	ALL	CM5015-48	CHROME	MS3454 */Jam nut	48	ALL	CM5015R-48	CHROME

*Consult factory for "SL" Series.

ADAPTOR SET PART NO.	ADAPTORS IN SET	COVERAGE (SHELL SIZE)
CM-S-5015	15	8 THRU 48
CM-S-5015S	10	8 THRU 28
CM-S-5015M	5	32 THRU 48

ADAPTOR SET PART NO.	ADAPTORS IN SET	COVERAGE (SHELL SIZE)
CM-S-5015R	15	8 THRU 48
CM-S-5015RS	10	8 THRU 28
CM-S-5015RM	5	32 THRU 48

MIL-DTL-22992 CLASS C, J & R

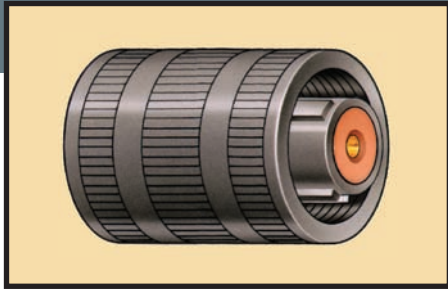

Plug Shown

MANUFACTURER:
BENDIX
ITT CANNON

SERIES:
HK, QWLD (10-194), 88-194
CWLD

SPECIFICATIONS:
COUPLING METHOD: QUICK DISCONNECT – THREADED COUPLING RINGS
KEYING POSITIONS: BLANK (NORMAL), W, X, Y, Z
ALTERNATE KEYING METHOD: ROTATION OF INSERT WITHIN SHELL – KEYS REMAIN STATIONARY
EMI/RFI GROUNDING: NO

SHELL MATERIAL & FINISH:

SHELL	FINISH
ALUMINUM	Hard Black Anodize Cadmium Olive Drab Over Nickel

TYPICAL CONNECTOR PART NUMBER BREAKDOWN

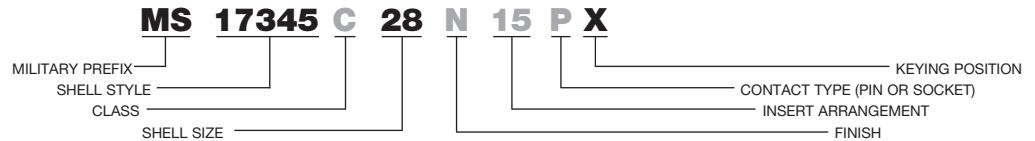

ADAPTOR TOOLS

PLUG (REMOVABLE PORTION)					RECEPTACLE (STATIONARY PORTION)				
BASIC IDENT. #/DESCRIPTION	SHELL SIZE	KEYING POSITIONS	ADAPTOR TOOL NUMBER	COLOR	BASIC IDENT. #/DESCRIPTION	SHELL SIZE	KEYING POSITIONS	ADAPTOR TOOL NUMBER	COLOR
MS17344 /Plug	12	ALL	CM229-12	BROWN	MS17343 /Wall mount MS17345 /In-line MS17346 /Box mount MS17347 /Jam nut wall mount MS17348 /Jam nut box mount	12	-	N/A	-
	14	ALL	CM229-14	BROWN		14	-	N/A	-
	16	ALL	CM229-16	BROWN		16	-	N/A	-
	18	ALL	CM229-18	BROWN		18	-	N/A	-
	20	ALL	CM229-20	BROWN		20	-	N/A	-
	22	ALL	CM229-22	BROWN		22	-	N/A	-
	24	ALL	CM229-24	BROWN		24	-	N/A	-
	36	ALL	CM229-36	BROWN		32	-	N/A	-
	40	ALL	CM229-40	BROWN		36	-	N/A	-
					40	-	N/A	-	

NOTE: For shell sizes 28, 32, 44 see Class "L", Page 8.

NA (Not available at time of printing – consult factory)

ADAPTOR SET PART NO.	ADAPTORS IN SET	COVERAGE (SHELL SIZE)	ADAPTOR SET PART NO.	ADAPTORS IN SET	COVERAGE (SHELL SIZE)
CM-S-229	9	12 THRU 40	N/A	-	-

MIL-DTL-22992 CLASS L

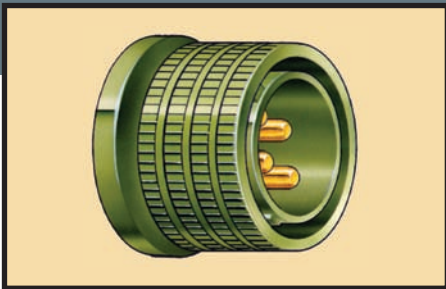

Straight Plug Shown

MANUFACTURER:
AMPHENOL
BENDIX
BURNDY
MATRIX SCIENCE

SERIES:
229
10-473
B555, B556, B557, B558
MHD

SPECIFICATIONS:

COUPLING METHOD: QUICK DISCONNECT –
THREADED COUPLING
RINGS

KEYING POSITIONS: N (NORMAL), W, X, Y
**ALTERNATE KEYING
METHOD:** ROTATION OF INSERT
WITHIN SHELL – KEYS
REMAIN STATIONARY

EMI/RFI GROUNDING: NO

SHELL MATERIAL & FINISH:

SHELL	FINISH
ALUMINUM	Hard Black Anodize Cadmium Olive Drab Over Nickel

**TYPICAL CONNECTOR
PART NUMBER
BREAKDOWN**

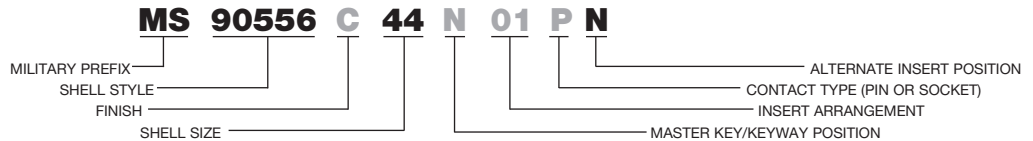

ADAPTOR TOOLS

PLUG (REMOVABLE PORTION)					RECEPTACLE (STATIONARY PORTION)				
BASIC IDENT. #/DESCRIPTION	SHELL SIZE	KEYING POSITIONS	ADAPTOR TOOL NUMBER	COLOR	BASIC IDENT. #/DESCRIPTION	SHELL SIZE	KEYING POSITIONS	ADAPTOR TOOL NUMBER	COLOR
MS90556 /Straight MS90558 /Wall mount	28	ALL	CM229L-28	BLACK	MS90555 /Wall mount MS90557 /In-line	28	–	N/A	–
	32	ALL	CM229L-32	BLACK		32	–	N/A	–
	44	ALL	CM229L-44	BLACK		44	–	N/A	–
	48	ALL	CM229L-48	BLACK		48	–	N/A	–
	52	ALL	CM229L-52	BLACK		52	–	N/A	–

NA (Not available at time of printing – consult factory)

ADAPTOR SET PART NO.	ADAPTORS IN SET	COVERAGE (SHELL SIZE)	ADAPTOR SET PART NO.	ADAPTORS IN SET	COVERAGE (SHELL SIZE)
CM-S-229L	5	28 THRU 52	N/A	–	–

MIL-DTL-26482 SERIES I & II

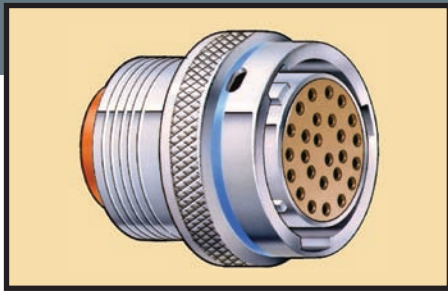

Straight Plug Shown

MANUFACTURER:	SERIES:
AERO ELECTRIC	AE77
AMPHENOL	118
BENDIX	DC, FPT(21-), PT, PT*CE, SP*CE, PT*SE, PTS*DR, SP
BURNDY	BT, L*T
CONNECTOR INDUSTRIES	C, K
DETRONICS	DT
DEUTSCH	AFD, DBC, RBC, 450, 460, 810, 880
ELECTRONIC SEALS	9-
GENERAL CONNECTOR	GC, GC*C
GLASSEAL	BE, GB
HERMETIC SEAL CORP.	S*A-7000, 7000
ITT CANNON	KPD, KPSE, KSSE, KP*, KS*, KPT, KSP, KPTM, KSPM PV, PVA, PVJ, PVW, PVX
MATRIX SCIENCE	MB1
SEALTRON	6300, 8100, 8300
S.E.C.	PW
SOURIAU	851, 851*R, 8526
VEAM/LITTON	VPT, VPT*SE, VUT

SPECIFICATIONS:
COUPLING METHOD: BAYONET
KEYING POSITIONS: BLANK (NORMAL), W, X, Y, Z
ALTERNATE KEYING METHOD: ROTATION OF INSERT KEYS REMAIN STATIONARY
EMI/RFI GROUNDING: YES (EMI/RFI GROUNDING FINGERS MAY NOT BE AVAILABLE ON ALL MODELS)

SHELL MATERIAL & FINISH:

SHELL	FINISH
ALUMINUM	Hard Anodize – Gray/Black Cadmium Olive Drab Cadmium Olive Drab Over Nickel
STEEL	Tin

TYPICAL CONNECTOR PART NUMBER BREAKDOWN

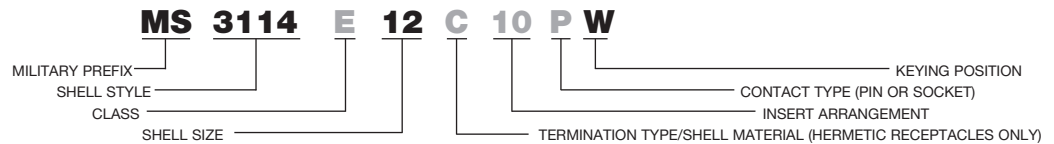

ADAPTOR TOOLS

PLUG (REMOVABLE PORTION)					RECEPTACLE (STATIONARY PORTION)				
BASIC IDENT. #/DESCRIPTION	SHELL SIZE	KEYING POSITIONS	ADAPTOR TOOL NUMBER	COLOR	BASIC IDENT. #/DESCRIPTION	SHELL SIZE	KEYING POSITIONS	ADAPTOR TOOL NUMBER	COLOR
MS3116 /Straight	8	ALL	CM264-8	ORANGE	MS3110 /Wall mount	8	ALL	CM264R-8	ORANGE
MS3126 /Straight	10	ALL	CM264-10	ORANGE	MS3111 /In-line	10	ALL	CM264R-10	ORANGE
MS3475 /Straight, RFI grounding	12	ALL	CM264-12	ORANGE	MS3112 /Box mount	12	ALL	CM264R-12	ORANGE
MS3476 /Straight	14	ALL	CM264-14	ORANGE	MS3113 /Hermetic seal solder mount	14	ALL	CM264R-14	ORANGE
MS3121 /Straight	16	ALL	CM264-16	ORANGE	MS3114 /Jam nut	16	ALL	CM264R-16	ORANGE
	18	ALL	CM264-18	ORANGE	MS3119 /Thru-bulkhead	18	ALL	CM264R-18	ORANGE
	20	ALL	CM264-20	ORANGE	MS3120 /Wall mount	20	ALL	CM264R-20	ORANGE
	22	ALL	CM264-22	ORANGE	MS3122 /Box mount	22	ALL	CM264R-22	ORANGE
	24	ALL	CM264-24	ORANGE	MS3124 /Jam nut	24	ALL	CM264R-24	ORANGE
					MS3127 /Large flange box mount				
					MS3128 /Large flange wall mount				
					MS3440 /Hermetic seal box mount				
					MS3442 /Wide flange hermetic seal box mount				
					MS3443 /Hermetic seal solder mount				
					MS3449 /Hermetic seal jam nut				
					MS3470 /Wall mount				
					MS3471 /In-line				
					MS3472 /Wide flange wall mount				
					MS3473 /Hermetic seal solder mount				
					MS3474 /Jam nut				
					MS3477 /Hermetic seal box mount				
					MS3479 /Hermetic seal jam nut				

ADAPTOR SET PART NO.	ADAPTORS IN SET	COVERAGE (SHELL SIZE)	ADAPTOR SET PART NO.	ADAPTORS IN SET	COVERAGE (SHELL SIZE)
CM-S-264	9	8 THRU 24	CM-S-264R	9	8 THRU 24

MIL-DTL-26500



Straight Plug Shown

MANUFACTURER:
 AMPHENOL
 BOEING
 CONNECTOR INDUSTRIES
 DETORONICS
 DEUTSCH
 ELECTRONIC SEALS
 GLASSEAL
 HERMETIC SEAL CORP.
 ITT CANNON
 MATRIX SCIENCE
 PYLE-NATIONAL
 SEALTRON
 SOURIAU
 TRW

SERIES:
 48, 48-7005, 518
 BACC45F, BACC63
 26500
 DX
 DB, DL, 94603
 26500
 50
 26500
 HTMF
 MB3, MT3
 B, BFH, F, ZZ
 6500, 6600, 8500, 8600
 8530
 C48, CN0915, CN0930, CN0942, CN0966, CN0967, MMB

SPECIFICATIONS:

COUPLING METHOD: BAYONET OR THREADED
KEYING POSITIONS: N (NORMAL), 1, 2, 3, 4, 5, 6, 7, 8, 9, 10

ALTERNATE KEYING METHOD: INSERT ROTATION IN POSITIONS 1 THRU 5, MINOR KEYS ROTATE IN POSITIONS 6 THRU 10

EMI/RFI GROUNDING: NO

SHELL MATERIAL & FINISH:

SHELL	FINISH
ALUMINUM	Anodize - Gray/Black Cadmium
STAINLESS STEEL	Passivated
STEEL	Tin Cadmium

TYPICAL CONNECTOR PART NUMBER BREAKDOWN

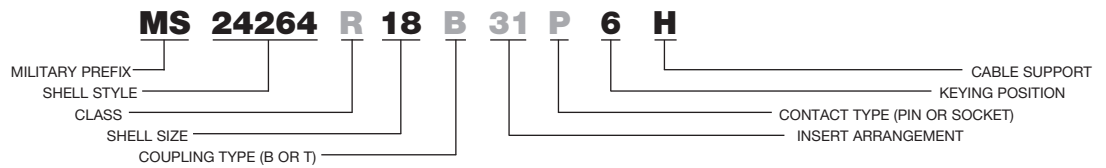

ADAPTOR TOOLS

PLUG (REMOVABLE PORTION)					RECEPTACLE (STATIONARY PORTION)					
BASIC IDENT. #/DESCRIPTION	SHELL SIZE	KEYING POSITIONS	ADAPTOR TOOL NUMBER	COLOR	BASIC IDENT. #/DESCRIPTION	SHELL SIZE	KEYING POSITIONS	ADAPTOR TOOL NUMBER	COLOR	
MS24266/ Straight MS27615/ Straight	8	N, 8, 9	CM837-8A*	GREEN	BAYONET COUPLINGS ONLY	MS24264/ Wall mount	8	ALL	CM837RB-8	GREEN
	8	6, 7	CM837-8B*	GREEN		MS24265/ Jam nut	10	ALL	CM837RB-10	GREEN
8	N, 8, 9	CM837-8C**	GREEN	MS27034/ Hermetic solder mount		12	ALL	CM837RB-12	GREEN	
8	6, 7	CM837-8D**	GREEN	MS27613/ Wall mount		14	ALL	CM837RB-14	GREEN	
10	N, 8, 9	CM837-10A	GREEN	MS27614/ Jam nut		16	ALL	CM837RB-16	GREEN	
10	6, 7, 10	CM837-10B	GREEN			18	ALL	CM837RB-18	GREEN	
12	N, 6, 8	CM837-12A	GREEN			20	ALL	CM837RB-20	GREEN	
12	7, 9, 10	CM837-12B	GREEN			22	ALL	CM837RB-22	GREEN	
14	N, 6, 8	CM837-14A	GREEN			24	ALL	CM837RB-24	GREEN	
14	7, 9, 10	CM837-14B	GREEN							
16	N, 6, 8	CM837-16A	GREEN							
16	7, 9, 10	CM837-16B	GREEN							
18	N, 6, 8	CM837-18A	GREEN							
18	7, 9, 10	CN837-18B	GREEN							
20	N, 6, 8	CM837-20A	GREEN							
20	7, 9, 10	CM837-20B	GREEN							
22	N, 6, 8	CM837-22A	GREEN							
22	7, 9, 10	CM837-22B	GREEN							
24	N, 6, 8	CM837-24A	GREEN							
24	7, 9, 10	CM837-24B	GREEN							
28	N, 6, 8	CM837-28A	GREEN							
28	7, 9, 10	CM837-28B	GREEN							

* For bayonet coupling connectors only. **For threaded coupling connectors only.

ADAPTOR SET PART NO.	ADAPTORS IN SET	COVERAGE (SHELL SIZE)	ADAPTOR SET PART NO.	ADAPTORS IN SET	COVERAGE (SHELL SIZE)
CM-S-837	22	8 THRU 28	CM-S-837RB	9	8 THRU 24

MIL-DTL-28840

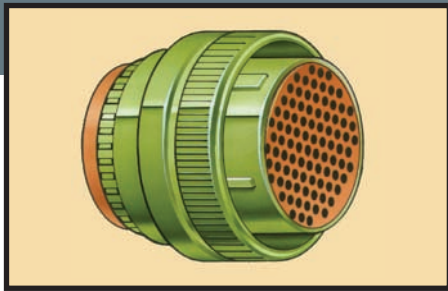

Straight Plug Shown

MANUFACTURER:
G & H TECHNOLOGY
HUGHES
ITT CANNON
IPI (SAE)

SERIES:
NC
GT, GS
KFS
HD

SPECIFICATIONS:
COUPLING METHOD: THREADED
KEYING POSITIONS: 1, 2, 3, 4, 5, 6
ALTERNATE KEYING METHOD: MASTER KEY REMAINS STATIONARY – MINOR KEYS ROTATE INDEPENDENTLY

EMI/RFI GROUNDING: YES (EMI/RFI GROUNDING FINGERS MAY NOT BE AVAILABLE ON ALL MODELS)

SHELL MATERIAL & FINISH:

SHELL	FINISH
ALUMINUM	Cadmium Olive Drab Over Nickel
STEEL	Cadmium

TYPICAL CONNECTOR PART NUMBER BREAKDOWN

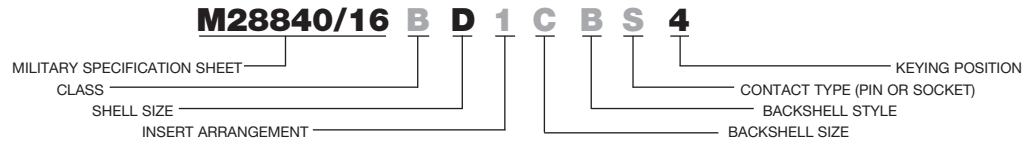

ADAPTOR TOOLS

PLUG (REMOVABLE PORTION)					RECEPTACLE (STATIONARY PORTION)				
BASIC IDENT. #/DESCRIPTION	SHELL SIZE	KEYING POSITIONS	ADAPTOR TOOL NUMBER	COLOR	BASIC IDENT. #/DESCRIPTION	SHELL SIZE	KEYING POSITIONS	ADAPTOR TOOL NUMBER	COLOR
M28840/16 /Straight	11(A)	1, 3, 5	CM288-11A	WHITE	M28840/10 /Wall mount	11(A)	1	CM288R-11A	WHITE
M28840/17 /Straight, straight strain relief	11(A)	2, 4, 6	CM288-11B	WHITE	M28840/11 /In-line	13(B)	1	CM288R-13A	WHITE
M28840/18 /Straight, 90° strain relief	13(B)	1, 3, 5	CM288-13A	WHITE	M28840/12 /Box mount	15(C)	1	CM288R-15A	WHITE
M28840/19 /Straight, 45° strain relief	13(B)	2, 4, 6	CM288-13B	WHITE	M28840/14 /Jam nut	17(D)	1	CM288R-17A	WHITE
M28840/26 /Straight, straight backshell for jacketed cable	15(C)	2, 3, 4	CM288-15A	WHITE	M28840/20 /Wall mount, EMI	19(E)	1	CM288R-19A	WHITE
M28840/28 /Straight, 90° backshell for jacketed cable	15(C)	1, 5, 6	CM288-15B	WHITE	M28840/21 /In-line, straight backshell for jacketed cable	23(F)	1	CM288R-23A	WHITE
M28840/29 /Straight, 45° backshell for jacketed cable	17(D)	2, 3, 4	CM288-17A	WHITE		25(G)	1	CM288R-25A	WHITE
	17(D)	1, 5, 6	CM288-17B	WHITE		29(H)	1	CM288R-29A	WHITE
	19(E)	2, 3, 4	CM288-19A	WHITE		33(J)	1	CM288R-33A	WHITE
	19(E)	1, 5, 6	CM288-19B	WHITE		11(A)	2, 3, 4, 5, 6	CM288R-11B	WHITE
	23(F)	2, 3, 4	CM288-23A	WHITE		13(B)	2, 3, 4, 5, 6	CM288R-13B	WHITE
	23(F)	1, 5, 6	CM288-23B	WHITE		15(C)	2, 3, 4, 5, 6	CM288R-15B	WHITE
	25(G)	2, 3, 4	CM288-25A	WHITE		17(D)	2, 3, 4, 5, 6	CM288R-17B	WHITE
	25(G)	1, 5, 6	CM288-25B	WHITE		19(E)	2, 3, 4, 5, 6	CM288R-19B	WHITE
	29(H)	2, 3, 4	CM288-29A	WHITE		23(F)	2, 3, 4, 5, 6	CM288R-23B	WHITE
	29(H)	1, 5, 6	CM288-29B	WHITE		25(G)	2, 3, 4, 5, 6	CM288R-25B	WHITE
	33(J)	2, 3, 4	CM288-33A	WHITE		29(H)	2, 3, 4, 5, 6	CM288R-29B	WHITE
	33(J)	1, 5, 6	CM288-33B	WHITE		33(J)	2, 3, 4, 5, 6	CM288R-33B	WHITE

ADAPTOR SET PART NO.	ADAPTORS IN SET	COVERAGE (SHELL SIZE)
CM-S-288	18	11 THRU 33

ADAPTOR SET PART NO.	ADAPTORS IN SET	COVERAGE (SHELL SIZE)
CM-S-288R	18	11 THRU 33

MIL-DTL-38999 SERIES I

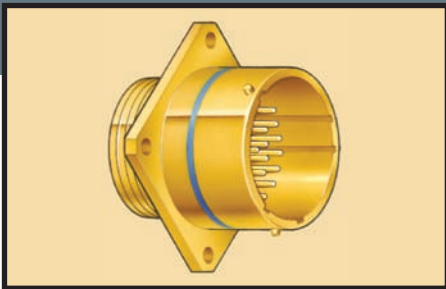

Wall Mount Receptacle Shown

MANUFACTURER:	SERIES:
AMPHENOL	416
BENDIX	LJT, 5388
CONNECTOR INDUSTRIES	G, P
DEUTSCH	CTC, DJT
ELECTRONIC SEALS	SERIES I
GLASSEAL	700
HERMETIC SEAL CORP.	900000
ITT CANNON	KJJL, KJL
MATRIX SCIENCE	MB91
PLESSEY	CT, LCT
SAE	HM (SERIES I)
SEALTRON	9700
SOURIAU	8LT

SPECIFICATIONS:

COUPLING METHOD: BAYONET
KEYING POSITIONS: BLANK (NORMAL),
 A, B, C, D
ALTERNATE KEYING METHOD: ROTATION OF MASTER
 KEY – MINOR KEYS
 REMAIN STATIONARY
EMI/RFI GROUNDING: YES (EMI/RFI GROUNDING
 FINGERS MAY NOT
 BE AVAILABLE ON
 ALL MODELS)

SHELL MATERIAL & FINISH:

SHELL	FINISH
ALUMINUM	Bright Cadmium Over Nickel Cadmium Olive Drab Over Nickel Anodize Nickel
STAINLESS STEEL	Passivated Nickel
STEEL	Fused Tin

TYPICAL CONNECTOR PART NUMBER BREAKDOWN

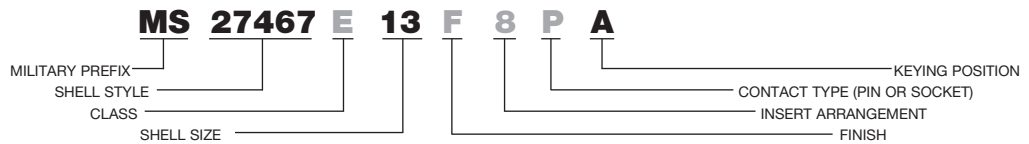

ADAPTOR TOOLS

PLUG (REMOVABLE PORTION)					RECEPTACLE (STATIONARY PORTION)				
BASIC IDENT. #/DESCRIPTION	SHELL SIZE	KEYING POSITIONS	ADAPTOR TOOL NUMBER	COLOR	BASIC IDENT. #/DESCRIPTION	SHELL SIZE	KEYING POSITIONS	ADAPTOR TOOL NUMBER	COLOR
MS27467 /Straight, EMI grounding	9	ALL	CM389L-9	BLUE	MS27466 /Wall mount	9	ALL	CM389LR-9	BLUE
MS27498 /90°	11	ALL	CM389L-11	BLUE	MS27468 /Jam nut	11	ALL	CM389LR-11	BLUE
MS27653 /Straight, EMI grounding	13	ALL	CM389L-13	BLUE	MS27469 /Hermetic wall mount	13	ALL	CM389LR-13	BLUE
MS27661 /Straight plug, lanyard release	15	ALL	CM389L-15	BLUE	MS27470 /Hermetic jam nut	15	ALL	CM389LR-15	BLUE
	17	ALL	CM389L-17	BLUE	MS27471 /Hermetic solder mount	17	ALL	CM389LR-17	BLUE
	19	ALL	CM389L-19	BLUE	MS27496 /Box mount	19	ALL	CM389LR-19	BLUE
	21	ALL	CM389L-21	BLUE	MS27505 /Box mount, (rear panel mounting)	21	ALL	CM389LR-21	BLUE
	23	ALL	CM389L-23	BLUE	MS27515 /Wall mount, (rear panel mounting)	23	ALL	CM389LR-23	BLUE
	25	ALL	CM389L-25	BLUE	MS27652 /Wall mount	25	ALL	CM389LR-25	BLUE
					MS27654 /Wall mount, (rear panel mounting)				
					MS27656 /Wall mount, (rear panel mounting)				
					MS27662 /Thru-bulkhead				

ADAPTOR SET PART NO.	ADAPTORS IN SET	COVERAGE (SHELL SIZE)	ADAPTOR SET PART NO.	ADAPTORS IN SET	COVERAGE (SHELL SIZE)
CM-S-389L	9	9 THRU 25	CM-S-389LR	9	9 THRU 25

MIL-DTL-38999 SERIES II



Straight Plug Shown

MANUFACTURER:	SERIES:
AMPHENOL	418
BENDIX	JT
CONNECTOR INDUSTRIES	G, H
DETORONICS	DJT
ELECTRONIC SEALS	SERIES II
GLASSEAL	800
HERMETIC SEAL CORP.	900000
ITT CANNON	KJ, KJJ
MATRIX SCIENCE	MB92
PLESSEY	CT
SAE	HM (SERIES II)
SEALTRON	9800
SOURIAU	8T

SPECIFICATIONS:
COUPLING METHOD: BAYONET
KEYING POSITIONS: BLANK (NORMAL),
 A, B, C, D
ALTERNATE KEYING METHOD: MASTER KEY ROTATES –
 MINOR KEYS REMAIN STATIONARY
EMI/RFI GROUNDING: YES (EMI/RFI GROUNDING
 FINGERS MAY NOT BE AVAILABLE ON ALL MODELS)

SHELL MATERIAL & FINISH:

SHELL	FINISH
ALUMINUM	Nickel Bright Cadmium Over Nickel Cadmium Olive Drab Over Nickel Anodize
STAINLESS STEEL	Passivated Nickel
STEEL	Fused Tin

TYPICAL CONNECTOR PART NUMBER BREAKDOWN

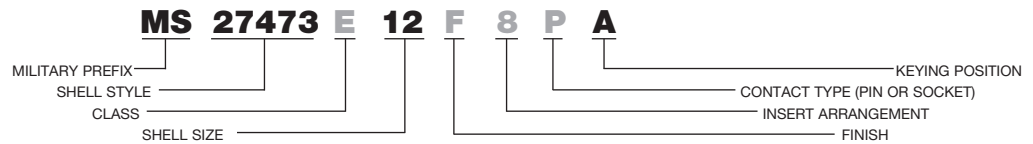

ADAPTOR TOOLS

PLUG (REMOVABLE PORTION)					RECEPTACLE (STATIONARY PORTION)				
BASIC IDENT. #/DESCRIPTION	SHELL SIZE	KEYING POSITIONS	ADAPTOR TOOL NUMBER	COLOR	BASIC IDENT. #/DESCRIPTION	SHELL SIZE	KEYING POSITIONS	ADAPTOR TOOL NUMBER	COLOR
MS27473 /Straight	8	ALL	CM389S-8	GRAY	MS27472 /Wall mount	8	ALL	CM264R-8	ORANGE
MS27480 /Straight	10	ALL	CM389S-10	GRAY	MS27474 /Jam nut	10	ALL	CM264R-10	ORANGE
MS27484 /Straight, EMI grounding	12	ALL	CM389S-12	GRAY	MS27475 /Hermetic wall mount	12	ALL	CM264R-12	ORANGE
MS27500 /90°	14	ALL	CM389S-14	GRAY	MS27476 /Hermetic box nut	14	ALL	CM264R-14	ORANGE
	16	ALL	CM389S-16	GRAY	MS27477 /Hermetic jam mount	16	ALL	CM264R-16	ORANGE
	18	ALL	CM389S-18	GRAY	MS27478 /Hermetic solder mount	18	ALL	CM264R-18	ORANGE
	20	ALL	CM389S-20	GRAY	MS27479 /Wall mount	20	ALL	CM264R-20	ORANGE
	22	ALL	CM389S-22	GRAY	MS27481 /Jam mount	22	ALL	CM264R-22	ORANGE
	24	ALL	CM389S-24	GRAY	MS27482 /Hermetic wall mount	24	ALL	CM264R-24	ORANGE
					MS27483 /Hermetic jam nut				
					MS27497 /Wall mount, back panel mounting				
					MS27499 /Box mount				
					MS27503 /Hermetic solder mount				
					MS27504 /Box mount				
					MS27508 /Box mount, back panel mounting				
					MS27513 /Box mount, long grommet				
					MS27664 /Wall mount, back panel mounting				

ADAPTOR SET PART NO.	ADAPTORS IN SET	COVERAGE (SHELL SIZE)	ADAPTOR SET PART NO.	ADAPTORS IN SET	COVERAGE (SHELL SIZE)
CM-S-389S	9	8 THRU 24	CM-S-264R	9	8 THRU 24

MIL-DTL-38999 SERIES III

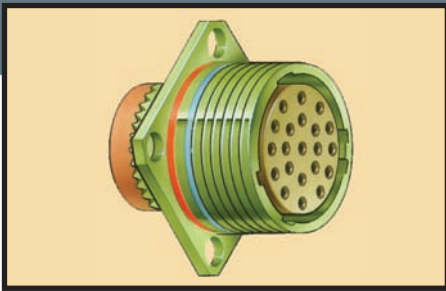

Wall Mount Receptacle Shown

MANUFACTURER:	SERIES:
BENDIX	TV, 5565
DEUTSCH	DTS
ELECTRONIC SEALS	SERIES III
ITT CANNON	KJA
MATRIX SCIENCE	MT93
PLESSEY	TCT
PYLE-NATIONAL	T3
SEALTRON	9900

SPECIFICATIONS:
COUPLING METHOD: THREADED, TRIPLE START SELF-LOCKING
KEYING POSITIONS: N (NORMAL), A, B, C, D, E
ALTERNATE KEYING METHOD: MASTER KEY REMAINS STATIONARY - MINOR KEYS ROTATE INDEPENDENTLY
EMI/RFI GROUNDING: YES (EMI/RFI GROUNDING FINGERS MAY NOT BE AVAILABLE ON ALL MODELS)

SHELL MATERIAL & FINISH:

SHELL	FINISH
ALUMINUM	Anodize Nickel Cadmium Olive Drab
STEEL	Passivated Nickel

TYPICAL CONNECTOR PART NUMBER BREAKDOWN

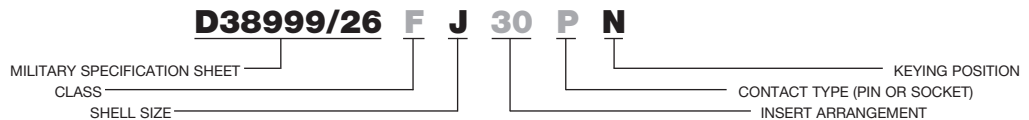

ADAPTOR TOOLS									
PLUG (REMOVABLE PORTION)					RECEPTACLE (STATIONARY PORTION)				
BASIC IDENT. #/DESCRIPTION	SHELL SIZE	KEYING POSITIONS	ADAPTOR TOOL NUMBER	COLOR	BASIC IDENT. #/DESCRIPTION	SHELL SIZE	KEYING POSITIONS	ADAPTOR TOOL NUMBER	COLOR
D38999/26 / Straight	9(A)	N, C, D	CM389T-9A	LAVENDER	D38999/20 / Wall mount	9(A)	N	CM389TR-9A	LAVENDER
D38999/29 / Lanyard release	9(A)	A, B, E	CM389T-9B	LAVENDER	D38999/21 / Hermetic seal box mount	11(B)	N	CM389TR-11A	LAVENDER
D38999/30 / Lanyard release	11(B)	N, D, E	CM389T-11A	LAVENDER	D38999/23 / Hermetic seal jam nut	13(C)	N	CM389TR-13A	LAVENDER
D38999/31 / Lanyard release	11(B)	A, B, C	CM389T-11B	LAVENDER	D38999/24 / Jam nut	15(D)	N	CM389TR-15A	LAVENDER
	13(C)	N, D, E	CM389T-13A	LAVENDER	D38999/25 / Hermetic seal solder mount	17(E)	N	CM389TR-17A	LAVENDER
	13(C)	A, B, C	CM389T-13B	LAVENDER	D38999/27 / Hermetic seal weld mount	19(F)	N	CM389TR-19A	LAVENDER
	15(D)	N, D, E	CM389T-15A	LAVENDER		21(G)	N	CM389TR-21A	LAVENDER
	15(D)	A, B, C	CM389T-15B	LAVENDER		23(H)	N	CM389TR-23A	LAVENDER
	17(E)	N, A, B	CM389T-17A	LAVENDER		25(J)	N	CM389TR-25A	LAVENDER
	17(E)	C, D, E	CM389T-17B	LAVENDER		9(A)	A, B, C, D, E	CM389TR-9B	LAVENDER
	19(F)	N, A, B	CM389T-19A	LAVENDER		11(B)	A, B, C, D, E	CM389TR-11B	LAVENDER
	19(F)	C, D, E	CM389T-19B	LAVENDER		13(C)	A, B, C, D, E	CM389TR-13B	LAVENDER
	21(G)	N, A, B	CM389T-21A	LAVENDER		15(D)	A, B, C, D, E	CM389TR-15B	LAVENDER
	21(G)	C, D, E	CM389T-21B	LAVENDER		17(E)	A, B, C, D, E	CM389TR-17B	LAVENDER
	23(H)	N, A, B	CM389T-23A	LAVENDER		19(F)	A, B, C, D, E	CM389TR-19B	LAVENDER
	23(H)	C, D, E	CM389T-23B	LAVENDER		21(G)	A, B, C, D, E	CM389TR-21B	LAVENDER
	25(J)	N, A, B	CM389T-25A	LAVENDER		23(H)	A, B, C, D, E	CM389TR-23B	LAVENDER
	25(J)	C, D, E	CM389T-25B	LAVENDER		25(J)	A, B, C, D, E	CM389TR-25B	LAVENDER

ADAPTOR SET PART NO.	ADAPTORS IN SET	COVERAGE (SHELL SIZE)
CM-S-389T	18	9 THRU 25

ADAPTOR SET PART NO.	ADAPTORS IN SET	COVERAGE (SHELL SIZE)
CM-S-389TR	18	9 THRU 25

MIL-DTL-38999 SERIES IV

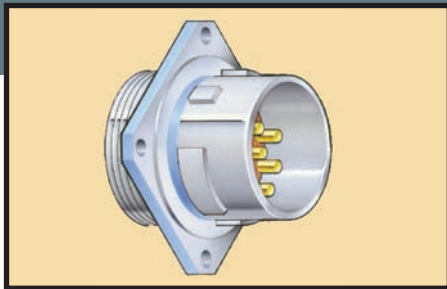

Wall Mount Receptacle Shown

MANUFACTURER:
DEUTSCH
ELECTRONIC SEALS
FLIGHT CONNECTOR
G & H TECHNOLOGY
MATRIX SCIENCE
TRW

SERIES:
DIV
SERIES IV
PL
BL
ML94
CN

SPECIFICATIONS:
COUPLING METHOD: BREECH-LOCK (SELF LOCKING)
KEYING POSITIONS: N (NORMAL), A, B, C, D
ALTERNATE KEYING METHOD: MASTER KEY REMAINS STATIONARY - INTERLOCKING SECTIONS ROTATE INDEPENDENTLY
EMI/RFI GROUNDING: YES (EMI/RFI GROUNDING FINGERS MAY NOT BE AVAILABLE ON ALL MODELS)

SHELL MATERIAL & FINISH:

SHELL	FINISH
ALUMINUM	Anodize Nickel Cadmium Olive Drab
STEEL	Passivated Nickel

TYPICAL CONNECTOR PART NUMBER BREAKDOWN

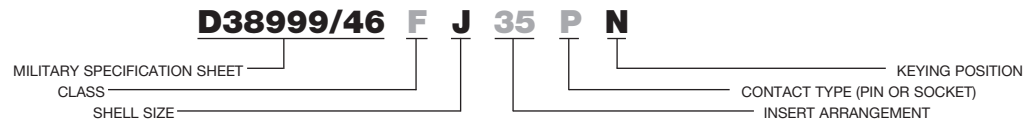

ADAPTOR TOOLS

PLUG (REMOVABLE PORTION)					RECEPTACLE (STATIONARY PORTION)				
BASIC IDENT. #/DESCRIPTION	SHELL SIZE	KEYING POSITIONS	ADAPTOR TOOL NUMBER	COLOR	BASIC IDENT. #/DESCRIPTION	SHELL SIZE	KEYING POSITIONS	ADAPTOR TOOL NUMBER	COLOR
D38999/46 /EMI straight	11(B)	ALL	CM389B-11	BEIGE	D38999/40 /Wall mount	11(B)	ALL	CM389BR-11	BEIGE
D38999/47 /Straight	13(C)	ALL	CM389B-13	BEIGE	D38999/41 /Hermetic box mount	13(C)	ALL	CM389BR-13	BEIGE
	15(D)	ALL	CM389B-15	BEIGE	D38999/42 /Box mount	15(D)	ALL	CM389BR-15	BEIGE
	17(E)	ALL	CM389B-17	BEIGE	D38999/43 /Hermetic jam nut	17(E)	ALL	CM389BR-17	BEIGE
	19(F)	ALL	CM389B-19	BEIGE	D38999/44 /Jam nut	19(F)	ALL	CM389BR-19	BEIGE
	21(G)	ALL	CM389B-21	BEIGE	D38999/45 /Hermetic solder mount	21(G)	ALL	CM389BR-21	BEIGE
	23(H)	ALL	CM389B-23	BEIGE	D38999/48 /Hermetic weld mount	23(H)	ALL	CM389BR-23	BEIGE
	25(J)	ALL	CM389B-25	BEIGE	D38999/49 /In-line	25(J)	ALL	CM389BR-25	BEIGE

ADAPTOR SET PART NO.	ADAPTORS IN SET	COVERAGE (SHELL SIZE)
CM-S-389B	8	11 THRU 25

ADAPTOR SET PART NO.	ADAPTORS IN SET	COVERAGE (SHELL SIZE)
CM-S-389BR	8	11 THRU 25

MIL-C-81511 SERIES I & III

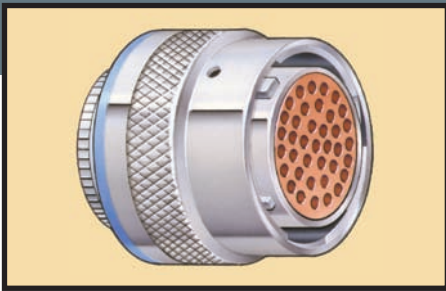

Straight Plug Shown

MANUFACTURER:
AMPHENOL
DEUTSCH
HERMETIC SEAL CORP.

SERIES:
348
815
10-00000

SPECIFICATIONS:
COUPLING METHOD: BAYONET
KEYING POSITIONS: 1, 2, 3, 4, 5, 6
ALTERNATE KEYING: MASTER KEY REMAINS STATIONARY – MINOR KEYS ROTATE INDEPENDENTLY
EMI/RFI GROUNDING: YES – PLUGS CONTAIN EMI/RFI GROUNDING FINGERS

SHELL MATERIAL & FINISH:

SHELL	FINISH
ALUMINUM	Nickel Cadmium Olive Drab Over Nickel Cadmium Olive Drab
STAINLESS STEEL	Passivated
STEEL	Tin

**TYPICAL CONNECTOR
PART NUMBER
BREAKDOWN**

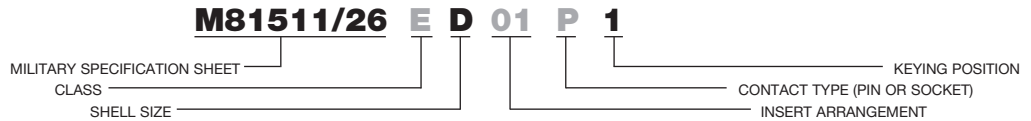

ADAPTOR TOOLS

PLUG (REMOVABLE PORTION)					RECEPTACLE (STATIONARY PORTION)				
BASIC IDENT. #/DESCRIPTION	SHELL SIZE	KEYING POSITIONS	ADAPTOR TOOL NUMBER	COLOR	BASIC IDENT. #/DESCRIPTION	SHELL SIZE	KEYING POSITIONS	ADAPTOR TOOL NUMBER	COLOR
M81511/26 /Straight	8(A)	1, 2, 3	CM815L-8A	YELLOW	M81511/21 /Wall mount	8(A)	ALL	CM815R-8	YELLOW
M81511/38 /Straight, potting seal	8(A)	4, 5, 6	CM815L-8B	YELLOW	M81511/22 /Hermetic seal solder mount	10(B)	ALL	CM815R-10	YELLOW
M81511/46 /Straight	10(B)	1, 2, 6	CM815L-10A	YELLOW	M81511/23 /Jam nut	14(D)	ALL	CM815R-14	YELLOW
	10(B)	3, 4, 5	CM815L-10B	YELLOW	M81511/24 /Hermetic seal jam nut	16(E)	ALL	CM815R-16	YELLOW
	14(D)	1, 2, 6	CM815L-14A	YELLOW	M81511/25 /In-line	18(F)	ALL	CM815R-18	YELLOW
	14(D)	3, 4, 5	CM815L-14B	YELLOW	M81511/27 /Hermetic seal jam nut	20(G)	ALL	CM815R-20	YELLOW
	16(E)	1, 2, 3	CM815L-16A	YELLOW	M81511/35 /Wall mount, potting seal	22(H)	ALL	CM815R-22	YELLOW
	16(E)	4, 5, 6	CM815L-16B	YELLOW	M81511/36 /Jam nut, potting seal	24(J)	ALL	CM815R-24	YELLOW
	18(F)	1, 2, 3	CM815L-18A	YELLOW	M81511/37 /In-line, potting seal				
	18(F)	4, 5, 6	CM815L-18B	YELLOW	M81511/41 /Wall mount				
	20(G)	1, 2, 3	CM815L-20A	YELLOW	M81511/42 /Hermetic seal solder mount (class D)				
	20(G)	4, 5, 6	CM815L-20B	YELLOW	M81511/44 /Hermetic seal jam nut (class D)				
	22(H)	1, 2, 3	CM815L-22A	YELLOW	M81511/45 /In-line				
	22(H)	4, 5, 6	CM815L-22B	YELLOW	M81511/47 /Hermetic seal solder mount (class L)				
	24(J)	1, 2, 3	CM815L-24A	YELLOW	M81511/48 /Hermetic seal jam nut (class L)				
	24(J)	4, 5, 6	CM815L-24B	YELLOW	M81511/49 /Jam nut				

ADAPTOR SET PART NO.	ADAPTORS IN SET	COVERAGE (SHELL SIZE)
CM-S-815L	16	8 THRU 24

ADAPTOR SET PART NO.	ADAPTORS IN SET	COVERAGE (SHELL SIZE)
CM-S-815R	8	8 THRU 24

MIL-C-81511 SERIES II & IV

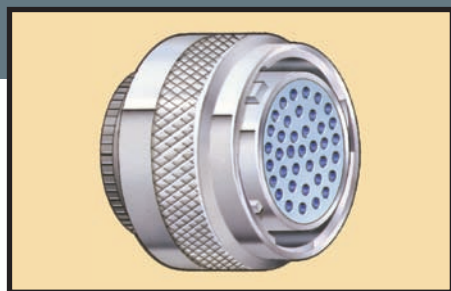

Straight Plug Shown

MANUFACTURER:
AMPHENOL
DEUTSCH
HERMETIC SEAL CORP.

SERIES:
348
815
10-00000

SPECIFICATIONS:
COUPLING METHOD: BAYONET
KEYING POSITIONS: 1, 2, 3, 4, 5, 6
ALTERNATE KEYING METHOD: MASTER KEY REMAINS STATIONARY – MINOR KEYS ROTATE INDEPENDENTLY

EMI/RFI GROUNDING: YES

SHELL MATERIAL & FINISH:

SHELL	FINISH
ALUMINUM	Nickel Cadmium Olive Drab Over Nickel Cadmium Olive Drab
STAINLESS STEEL	Passivated
STEEL	Tin

TYPICAL CONNECTOR PART NUMBER BREAKDOWN

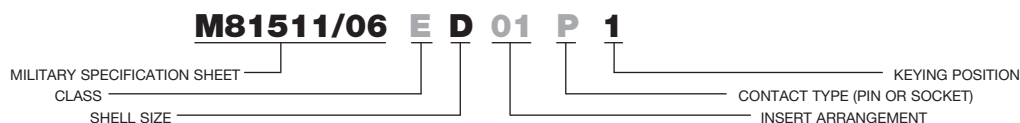

ADAPTOR TOOLS

PLUG (REMOVABLE PORTION)					RECEPTACLE (STATIONARY PORTION)				
BASIC IDENT. #/DESCRIPTION	SHELL SIZE	KEYING POSITIONS	ADAPTOR TOOL NUMBER	COLOR	BASIC IDENT. #/DESCRIPTION	SHELL SIZE	KEYING POSITIONS	ADAPTOR TOOL NUMBER	COLOR
M81511/06/Straight	8(A)	ALL	CM815S-8	RED	M81511/01/Wall mount	8(A)	ALL	CM815R-8	YELLOW
M81511/34/Straight, potting seal	10(B)	1, 4, 5	CM815S-10A	RED	M81511/02/Hermetic seal solder mount	10(B)	ALL	CM815R-10	YELLOW
M81511/56/Straight	10(B)	2, 3, 6	CM815S-10B	RED	M81511/03/Jam nut	14(D)	ALL	CM815R-14	YELLOW
	14(D)	1, 4, 5	CM815S-14A	RED	M81511/04/Hermetic seal jam nut	16(E)	ALL	CM815R-16	YELLOW
	14(D)	2, 3, 6	CM815S-14B	RED	M81511/05/In-line	18(F)	ALL	CM815R-18	YELLOW
	16(E)	1, 2, 4	CM815S-16A	RED	M81511/28/Hermetic seal jam nut	20(G)	ALL	CM815R-20	YELLOW
	16(E)	3, 5, 6	CM815S-16B	RED	M81511/31/Wall mount, potting seal	22(H)	ALL	CM815R-22	YELLOW
	18(F)	1, 2, 4	CM815S-18A	RED	M81511/32/Jam nut, potting seal	24(H)	ALL	CM815R-24	YELLOW
	18(F)	3, 5, 6	CM815S-18B	RED	M81511/33/In-line, potting seal				
					M81511/50/Hermetic seal jam nut (class L)				
					M81511/51/Wall mount				
					M81511/52/Hermetic seal solder mount (class D)				
					M81511/53/Jam nut				
					M81511/54/Hermetic seal jam nut (class L)				
					M81511/55/In-line				
					M81511/57/Hermetic seal solder mount (class L)				

ADAPTOR SET PART NO.	ADAPTORS IN SET	COVERAGE (SHELL SIZE)	ADAPTOR SET PART NO.	ADAPTORS IN SET	COVERAGE (SHELL SIZE)
CM-S-815S	9	8 THRU 18	CM-S-815R	8	8 THRU 24

MIL-DTL-83723 SERIES I (REF: MIL-C-26482)

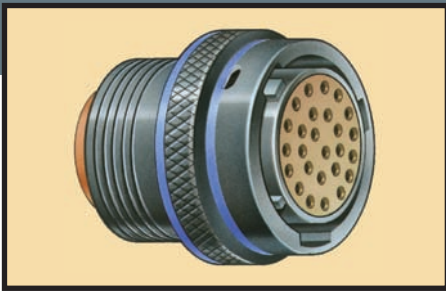

Straight Plug Shown

MANUFACTURER:
AERO ELECTRIC
AMPHENOL
BENDIX
BURNDY
CONNECTOR INDUSTRIES
DETRONICS
DEUTSCH
ELECTRONIC SEALS
GENERAL CONNECTOR
GLASSEAL
HERMETIC SEAL CORP.
ITT CANNON

MATRIX SCIENCE
SEALTRON
S.E.C.
SOURIAU
VEAM/LITTON

SERIES:
AE77
118
DC, FPT(21-), PT, PT*CE, SP*CE, PT*SE, PTS*DR, SP
BT, L*T
C, K
DT
AFD, DBC, RBC, 450, 460, 810, 880
9-
GC, GC*C
BE, GB
S*A-7000, 7000
KPD, KPSE, KSSE, KP*, KS*, KPT, KSP, KPTM, KSPM, PV,
PVA, PVJ, PVW, PVX
MB1
6300, 8100, 8300
PW
851, 851*R, 8526
VPT, VPT*SE, VUT

SPECIFICATIONS:

COUPLING METHOD: BAYONET
KEYING POSITIONS: N (NORMAL), W, X, Y, Z
ALTERNATE KEYING METHOD: ROTATION OF INSERT – KEYS REMAIN STATIONARY
EMI/RFI GROUNDING: YES (EMI/RFI GROUNDING FINGERS MAY NOT BE AVAILABLE ON ALL MODELS)

SHELL MATERIAL & FINISH:

SHELL	FINISH
ALUMINUM	Anodize Nickel
STAINLESS STEEL	Passivated
STEEL	Tin

TYPICAL CONNECTOR PART NUMBER BREAKDOWN

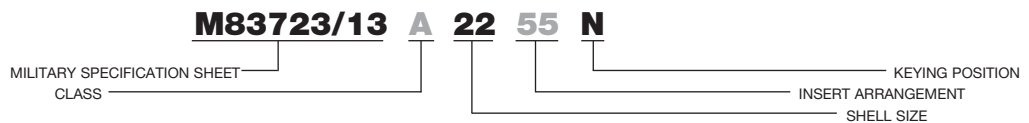

ADAPTOR TOOLS

PLUG (REMOVABLE PORTION)					RECEPTACLE (STATIONARY PORTION)				
BASIC IDENT. #/DESCRIPTION	SHELL SIZE	KEYING POSITIONS	ADAPTOR TOOL NUMBER	COLOR	BASIC IDENT. #/DESCRIPTION	SHELL SIZE	KEYING POSITIONS	ADAPTOR TOOL NUMBER	COLOR
M83723/13 /Straight	8	ALL	CM264-8	ORANGE	M83723/01 /Narrow flange wall mount	8	ALL	CM264R-8	ORANGE
M83723/14 /Straight	10	ALL	CM264-10	ORANGE	M83723/02 /Narrow flange wall mount	10	ALL	CM264R-10	ORANGE
M82723/36 /Prewired size 8 straight	12	ALL	CM264-12	ORANGE	M83723/03 /Wide flange wall mount	12	ALL	CM264R-12	ORANGE
M83723/37 /Prewired size 8 straight	14	ALL	CM264-14	ORANGE	M83723/04 /Wide flange wall mount	14	ALL	CM264R-14	ORANGE
M83723/42 /Straight, RFI grounding	16	ALL	CM264-16	ORANGE	M83723/05 /Jam nut	16	ALL	CM264R-16	ORANGE
M83723/43 /Straight, RFI grounding	18	ALL	CM264-18	ORANGE	M83723/06 /Jam nut	18	ALL	CM264R-18	ORANGE
M83723/43 /Straight, RFI grounding	20	ALL	CM264-20	ORANGE	M83723/07 /In-line	20	ALL	CM264R-20	ORANGE
M83723/48 /Prewired size 8 straight, RFI grounding	22	ALL	CM264-22	ORANGE	M83723/08 /In-line	22	ALL	CM264R-22	ORANGE
M83723/49 /Prewired size 8 straight, RFI grounding	24	ALL	CM264-24	ORANGE	M83723/09 /Hermetic narrow flange box mount	24	ALL	CM264R-24	ORANGE
					M83723/10 /Hermetic wide flange box mount				
					M83723/11 /Hermetic solder mount				
					M83723/12 /Hermetic jam nut				
					M83723/38 /Prewired size 8 narrow flange wall mount				
					M83723/39 /Prewired size 8 narrow flange wall mount				
					M83723/40 /Prewired size 8 wide flange wall mount				
					M83723/41 /Prewired size 8 wide flange wall mount				

ADAPTOR SET PART NO.	ADAPTORS IN SET	COVERAGE (SHELL SIZE)
CM-S-264	9	8 THRU 24

ADAPTOR SET PART NO.	ADAPTORS IN SET	COVERAGE (SHELL SIZE)
CM-S-264R	9	8 THRU 24

MIL-DTL-83723 SERIES II (REF: MIL-C-5015)

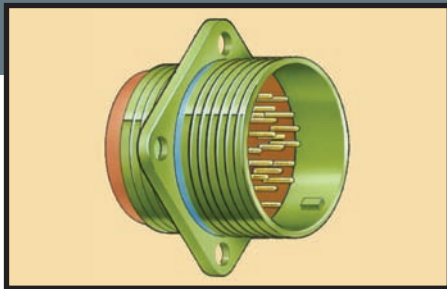

Wall Mount Receptacle Shown

MANUFACTURER:

AERO ELECTRIC
AMPHENOL
BENDIX

BURNDY
CONNECTOR INDUSTRIES
DETORONICS
ELECTRONIC SEALS
FLIGHT CONNECTOR
GLASSEAL
HERMETIC SEAL CORP.
ITT CANNON

MATRIX SCIENCE
SAE
SEALTRON
VEAM/LITTON

SERIES:

AE55, AE723
69, 72, 97, 157, 172, 173, 179, 208, 238, 246
BT-M, BT-RA, HT, SCP, TBF, 10-72, 10-214, 10-244, 10-741,
10-747, 10-873, 10-874, 5015
LM*C
A
DS
5015
FC, FH, FF0, FF5, FZC, FZJ
GSP
HS06, S*A-2000, 2000
BFH, BFR, CA, CA-EA, CA-EB, CA-HR, CA-KE, CA-RX, CV,
CVA, EX-A, FRA, FRF, FVA, FVF, FW, GS, MR, TBF, TBFH, WFS
MFR, M723, 944, 981
M0, M5, SA
6000, 8000
VE, VS, VTBF, 10/71, 75

SPECIFICATIONS:

COUPLING METHOD: THREADED
KEYING POSITIONS: N (NORMAL), W, X, Y, Z
ALTERNATE KEYING METHOD: ROTATION OF INSERT - KEYS REMAIN STATIONARY
EMI/RFI GROUNDING: NO

SHELL MATERIAL & FINISH:

SHELL	FINISH
ALUMINUM	Anodize Nickel
STEEL	Tin
STAINLESS STEEL	Passivated

TYPICAL CONNECTOR PART NUMBER BREAKDOWN

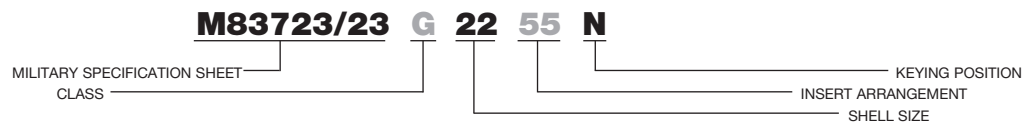

ADAPTOR TOOLS

PLUG (REMOVABLE PORTION)					RECEPTACLE (STATIONARY PORTION)				
BASIC IDENT. #/DESCRIPTION	SHELL SIZE	KEYING POSITIONS	ADAPTOR TOOL NUMBER	COLOR	BASIC IDENT. #/DESCRIPTION	SHELL SIZE	KEYING POSITIONS	ADAPTOR TOOL NUMBER	COLOR
M83723/23 /Straight	8	ALL	CM5015-8	CHROME	M83723/17 /In-line	8	ALL	CM5015R-8	CHROME
M83723/24 /Straight	10	ALL	CM5015-10	CHROME	M83723/18 /In-line	10	ALL	CM5015R-10	CHROME
M83723/52 /Straight, self-locking coupling nut	12	ALL	CM5015-12	CHROME	M83723/19 /Wall mount	12	ALL	CM5015R-12	CHROME
M83723/53 /Straight, self-locking coupling nut	14	ALL	CM5015-14	CHROME	M83723/20 /Wall mount	14	ALL	CM5015R-14	CHROME
	16	ALL	CM5015-16	CHROME	M83723/21 /Box mount	16	ALL	CM5015R-16	CHROME
	18	ALL	CM5015-18	CHROME	M83723/22 /Box mount	18	ALL	CM5015R-18	CHROME
	20	ALL	CM5015-20	CHROME	M83723/25 /Box mount hermetic	20	ALL	CM5015R-20	CHROME
	22	ALL	CM5015-22	CHROME	M83723/26 /Solder mount hermetic	22	ALL	CM5015R-22	CHROME
	24	ALL	CM5015-24	CHROME		24	ALL	CM5015R-24	CHROME
	28	ALL	CM5015-28	CHROME		28	ALL	CM5015R-28	CHROME
	32	ALL	CM5015-32	CHROME		32	ALL	CM5015R-32	CHROME
	36	ALL	CM5015-36	CHROME		36	ALL	CM5015R-36	CHROME
	40	ALL	CM5015-40	CHROME		40	ALL	CM5015R-40	CHROME
	44	ALL	CM5015-44	CHROME		44	ALL	CM5015R-44	CHROME
	48	ALL	CM5015-48	CHROME		48	ALL	CM5015R-48	CHROME

ADAPTOR SET PART NO.	ADAPTORS IN SET	COVERAGE (SHELL SIZE)	ADAPTOR SET PART NO.	ADAPTORS IN SET	COVERAGE (SHELL SIZE)
CM-S-5015	15	8 THRU 48	CM-S-5015R	15	8 THRU 48

MIL-DTL-83723 SERIES III (REF: MIL-C-26500)

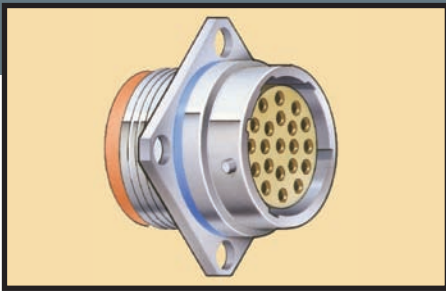

Wall Mount Receptacle Shown

MANUFACTURER:	SERIES:
AMPHENOL	48, 518
BOEING	BACC45F
CONNECTOR INDUSTRIES	MIL-C-83723 SERIES III
DETORONICS	DX
DEUTSCH	DB, DL, 94603
GLASSEAL	50
HERMETIC SEAL CORP.	83723
ITT CANNON	HTMF
MATRIX SCIENCE	MB3, MT3
PYLE-NATIONAL	B, BFH
SEALTRON	6500, 6600
SOURIAU	83723, 8530
TRW	CN0930, CN0966, CN0967

SPECIFICATIONS:
COUPLING METHOD: BAYONET OR THREADED
KEYING POSITIONS: N (NORMAL), 1, 2, 3, 4, 5, 6, 7, 8, 9, 10
ALTERNATE KEYING METHOD: INSERT ROTATION IN POSITIONS 1 THRU 5, MINOR KEY ROTATION IN POSITIONS 6 THRU 10
EMI/RFI GROUNDING: YES (EMI/RFI FINGERS MAY NOT BE AVAILABLE ON ALL MODELS)

SHELL MATERIAL & FINISH:

SHELL	FINISH
ALUMINUM	Black anodize Cadmium
STAINLESS STEEL	Passivated Nickel
STEEL	Tin

TYPICAL CONNECTOR PART NUMBER BREAKDOWN

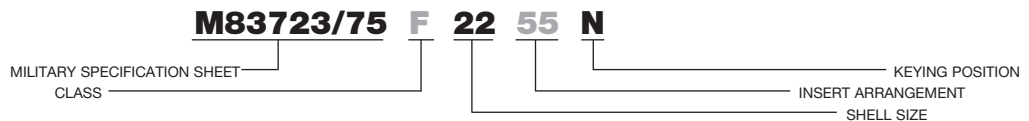

ADAPTOR TOOLS

PLUG (REMOVABLE PORTION)					RECEPTACLE (STATIONARY PORTION)*				
BASIC IDENT. #/DESCRIPTION	SHELL SIZE	KEYING POSITIONS	ADAPTOR TOOL NUMBER	COLOR	BASIC IDENT. #/DESCRIPTION	SHELL SIZE	KEYING POSITIONS	ADAPTOR TOOL NUMBER	COLOR
MS83723/75 /Straight	8	N, 8, 9	CM837-8A*	GREEN	MS83723/71 /Wall mount	8	ALL	CM837RB-8	GREEN
MS83723/76 /Straight	8	6, 7	CM837-8B*	GREEN	MS83723/72 /Wall mount	10	ALL	CM837RB-10	GREEN
MS83723/86 /Straight	8	N, 8, 9	CM837-8C**	GREEN	MS83723/82 /Wall mount	12	ALL	CM837RB-12	GREEN
MS83723/87 /Straight	8	6, 7	CM837-8D**	GREEN	MS83723/83 /Wall mount	14	ALL	CM837RB-14	GREEN
MS83723/77 /Straight, EMI grounding	8	6, 7	CM837-8D**	GREEN	MS83723/79 /Box mount, hermetic seal	16	ALL	CM837RB-16	GREEN
MS83723/78 /Straight, EMI grounding	10	N, 8, 9	CM837-10A	GREEN	MS83723/88 /Box mount, hermetic seal	18	ALL	CM837RB-18	GREEN
MS83723/91 /Straight, EMI grounding	10	6, 7, 10	CM837-10B	GREEN	MS83723/73 /Jam nut	20	ALL	CM837RB-20	GREEN
MS83723/92 /Straight, EMI grounding	10	6, 7, 10	CM837-10B	GREEN	MS83723/74 /Jam nut	22	ALL	CM837RB-22	GREEN
MS83723/95 /Straight, self-locking coupling nut	12	N, 6, 8	CM837-12A	GREEN	MS83723/85 /Jam nut	24	ALL	CM837RB-24	GREEN
MS83723/96 /Straight, self-locking coupling nut	12	7, 9, 10	CM837-12B	GREEN	MS83723/81 /Jam nut, hermetic seal				
MS83723/97 /Straight, self-locking coupling nut, EMI grounding	14	N, 6, 8	CM837-14A	GREEN	MS83723/89 /Jam nut, hermetic seal				
MS83723/98 /Straight, self-locking coupling nut, EMI grounding	14	7, 9, 10	CM837-14B	GREEN	MS83723/94 /Jam nut, hermetic seal				
MS83723/98 /Straight, self-locking coupling nut, EMI grounding	16	N, 6, 8	CM837-16A	GREEN	MS83723/65 /Jam nut, hermetic seal				
MS83723/66 /Straight, push-pull quick disconnect	16	7, 9, 10	CM837-16B	GREEN	MS83723/80 /Solder mount, hermetic seal				
MS83723/67 /Straight, push-pull quick disconnect	18	N, 6, 8	CM837-18A	GREEN	MS83723/90 /Solder mount, hermetic seal				
MS83723/67 /Straight, push-pull quick disconnect	18	7, 9, 10	CN837-18B	GREEN	MS83723/93 /Solder mount, hermetic seal				
MS83723/68 /Straight, push-pull quick disconnect, lanyard	20	N, 6, 8	CM837-20A	GREEN					
MS83723/69 /Straight, push-pull quick disconnect, lanyard	20	7, 9, 10	CM837-20B	GREEN					
	22	N, 6, 8	CM837-22A	GREEN					
	22	7, 9, 10	CM837-22B	GREEN					
	24	N, 6, 8	CM837-24A	GREEN					
	24	7, 9, 10	CM837-24B	GREEN					
	28	N, 6, 8	CM837-28A	GREEN					
	28	7, 9, 10	CM837-28B	GREEN					

* For bayonet coupling only. **For threaded coupling connectors only.

* Bayonet coupling only. Adaptors not available for connectors with threaded coupling.

ADAPTOR SET PART NO.	ADAPTORS IN SET	COVERAGE (SHELL SIZE)	ADAPTOR SET PART NO.	ADAPTORS IN SET	COVERAGE (SHELL SIZE)
CM-S-837	22	8 THRU 28	CM-S-837RB*	9	8 THRU 24

PATTERN 602

PAN 6432-4, EL2112

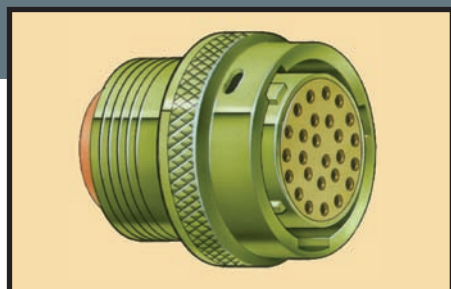

Straight Plug Shown

MANUFACTURER:
 AMPHENOL
 CANNON ELECTRIC GB
 HELLERMANN DEUTSCH
 SOURIAU

SERIES:
 602GB
 PVX
 RR
 8526

SPECIFICATIONS:
COUPLING METHOD: BAYONET
KEYING POSITIONS: N (NORMAL), B, C, E, F FOR SHELL;
 N (NORMAL), W, X, Y, Z FOR INSERT

ALTERNATE KEYING METHOD: MASTER KEY REMAINS STATIONARY – MINOR KEYS AND BAYONET PINS ROTATE. ALSO, INSERT ROTATES

EMI/RFI GROUNDING: YES (EMI/RFI GROUNDING FINGERS MAY NOT BE AVAILABLE ON ALL MODELS)

SHELL MATERIAL & FINISH:

SHELL	FINISH
ALUMINUM	Cadmium Olive Drab

TYPICAL CONNECTOR PART NUMBER BREAKDOWN

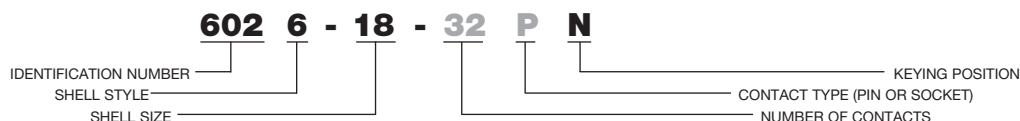

ADAPTOR TOOLS					ADAPTOR TOOLS				
PLUG (REMOVABLE PORTION)					RECEPTACLE (STATIONARY PORTION)				
BASIC IDENT. #/DESCRIPTION	SHELL SIZE	KEYING POSITIONS	ADAPTOR TOOL NUMBER	COLOR	BASIC IDENT. #/DESCRIPTION	SHELL SIZE	KEYING POSITIONS	ADAPTOR TOOL NUMBER	COLOR
6026/Plug	8	N	CM602-8A	PURPLE	6020/Square flange	8	ALL	CM264R-8	ORANGE
	8	E, F	CM602-8B	PURPLE	6027/Jam nut	10	ALL	CM264R-10	ORANGE
	10	N, B, C	CM602-10A	PURPLE	6021H/Solder fixing hermetic	12	ALL	CM264R-12	ORANGE
	10	E, F	CM602-10B	PURPLE	6027H/Jam nut hermetic	14	ALL	CM264R-14	ORANGE
	12	N, B, C	CM602-12A	PURPLE		16	ALL	CM264R-16	ORANGE
	12	E, F	CM602-12B	PURPLE		18	ALL	CM264R-18	ORANGE
	14	N, B, C	CM602-14A	PURPLE		20	ALL	CM264R-20	ORANGE
	14	E, F	CM602-14B	PURPLE		22	ALL	CM264R-22	ORANGE
	16	N, B, C	CM602-16A	PURPLE		24	ALL	CM264R-24	ORANGE
	16	E, F	CM602-16B	PURPLE					
	18	N, B, C	CM602-18A	PURPLE					
	18	E, F	CM602-18B	PURPLE					
	20	N, B, C	CM602-20A	PURPLE					
	20	E, F	CM602-20B	PURPLE					
	22	N, B, C	CM602-22A	PURPLE					
	22	E, F	CM602-22B	PURPLE					
	24	N, B, C	CM602-24A	PURPLE					
	24	E, F	CM602-24B	PURPLE					

ADAPTOR SET PART NO.	ADAPTORS IN SET	COVERAGE (SHELL SIZE)
CM-S-602	18	8 THRU 24

ADAPTOR SET PART NO.	ADAPTORS IN SET	COVERAGE (SHELL SIZE)
CM-S-264R	9	8 THRU 24

PATTERN 615

PAN 6433-2

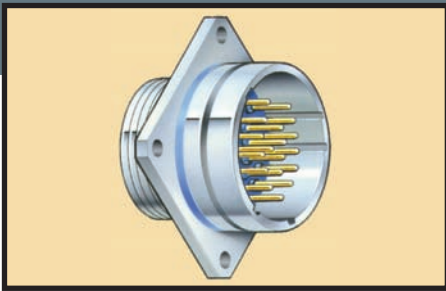

Wall Mount Receptacle Shown

MANUFACTURER:
BENDIX
PLESSEY

SERIES:
SJT
MK26

SPECIFICATIONS:

COUPLING METHOD: BAYONET
KEYING POSITIONS: BLANK (NORMAL),
A, B, C, D
ALTERNATE KEYING METHOD: MASTER KEY ROTATES –
MINOR KEYS REMAIN STATIONARY
EMI/RFI GROUNDING: YES (EMI/RFI GROUNDING
FINGERS MAY NOT BE AVAILABLE ON ALL
MODELS)

SHELL MATERIAL & FINISH:

SHELL	FINISH
ALUMINUM	Cadmium Over Nickel Bright Cadmium Cadmium Olive Drab Gray Anodize Anodic Coating (Alumilite) Bright Nickel Chromate Treated (Iridite 14-2) Cadmium Olive Drab Over Nickel Nickel
STEEL	Tin
STAINLESS STEEL	Passivated

TYPICAL CONNECTOR PART NUMBER BREAKDOWN

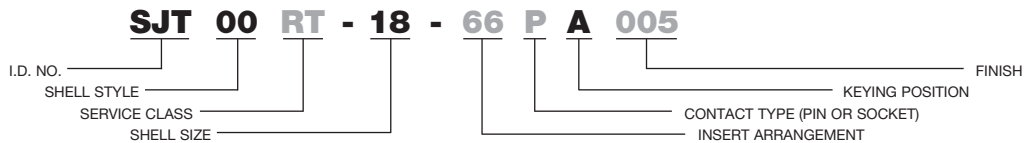

ADAPTOR TOOLS

PLUG (REMOVABLE PORTION)					RECEPTACLE (STATIONARY PORTION)				
BASIC IDENT. #/DESCRIPTION	SHELL SIZE	KEYING POSITIONS	ADAPTOR TOOL NUMBER	COLOR	BASIC IDENT. #/DESCRIPTION	SHELL SIZE	KEYING POSITIONS	ADAPTOR TOOL NUMBER	COLOR
SJT06RT /Straight SJT06RT /Straight, RFI grounding fingers	8	ALL	CMSJT-8	GOLD	SJT00RT /Wall mount SJTP02RE /Box mount SJTP00RT /Wall mount SJT07RT /Jam nut SJT1Y /Solder mount hermetic SJT07Y /Jam nut hermetic	8	ALL	CM264R-8	ORANGE
	10	ALL	CMSJT-10	GOLD		10	ALL	CM264R-10	ORANGE
	12	ALL	CMSJT-12	GOLD		12	ALL	CM264R-12	ORANGE
	14	ALL	CMSJT-14	GOLD		14	ALL	CM264R-14	ORANGE
	16	ALL	CMSJT-16	GOLD		16	ALL	CM264R-16	ORANGE
	18	ALL	CMSJT-18	GOLD		18	ALL	CM264R-18	ORANGE
	20	ALL	CMSJT-20	GOLD		20	ALL	CM264R-20	ORANGE
	22	ALL	CMSJT-22	GOLD		22	ALL	CM264R-22	ORANGE
	24	ALL	CMSJT-24	GOLD		24	ALL	CM264R-24	ORANGE

ADAPTOR SET PART NO.	ADAPTORS IN SET	COVERAGE (SHELL SIZE)
CM-S-SJT	9	8 THRU 24

ADAPTOR SET PART NO.	ADAPTORS IN SET	COVERAGE (SHELL SIZE)
CM-S-264R	9	8 THRU 24

CONNECTOR IDENTIFICATION

THIS TABLE CAN BE USED TO IDENTIFY THE ADAPTOR TOOL SERIES REQUIRED FOR A PARTICULAR CONNECTOR. IF YOU KNOW THE COMMERCIAL OR MILITARY PREFIX OF THE CONNECTOR PART NUMBER, FIND IT IN THE LEFT COLUMN. IN THE SECOND COLUMN WILL BE THE APPLICABLE PAGE NUMBER FOR THE ADAPTOR TOOL SERIES, ALONG WITH MANUFACTURER AND SPECIFICATION REFERENCE INFORMATION.

PREFIX	PAGE	MANUFACTURER	CONNECTOR SERIES (REFERENCE)
10-00000	16	HERMETIC SEAL CORP.	MIL-C-81511 SERIES 1 & 3
10-00000	17	HERMETIC SEAL CORP.	MIL-C-81511 SERIES 2 & 4
10-194	7	BENDIX	MIL-C-22992 CLASSES C, J, R
10-214	6	BENDIX	MIL-C-5015
10-214	19	BENDIX	MIL-C-83723 SERIES II
10-244	6	BENDIX	MIL-C-5015
10-244	19	BENDIX	MIL-C-83723 SERIES II
10-473	8	BENDIX	MIL-C-22992 CLASS L
10-72	6	BENDIX	MIL-C-5015
10-72	19	BENDIX	MIL-C-83723 SERIES II
10-741	6	BENDIX	MIL-C-5015
10-741	19	BENDIX	MIL-C-83723 SERIES II
10-747	6	BENDIX	MIL-C-5015
10-747	19	BENDIX	MIL-C-83723 SERIES II
10-873	6	BENDIX	MIL-C-5015
10-873	19	BENDIX	MIL-C-83723 SERIES II
10-874	6	BENDIX	MIL-C-5015
10-874	19	BENDIX	MIL-C-83723 SERIES II
1071	6	VEAM/LITTON	MIL-C-5015
1071	19	VEAM/LITTON	MIL-C-83723 SERIES II
118	9	AMPHENOL	MIL-C-26482 SERIES 1 & 2
118	18	AMPHENOL	MIL-C-83723 SERIES I
157	6	AMPHENOL	MIL-C-5015
157	19	AMPHENOL	MIL-C-83723 SERIES II
172	6	AMPHENOL	MIL-C-5015
172	19	AMPHENOL	MIL-C-83723 SERIES II
173	6	AMPHENOL	MIL-C-5015
173	19	AMPHENOL	MIL-C-83723 SERIES II
179	6	AMPHENOL	MIL-C-5015
179	19	AMPHENOL	MIL-C-83723 SERIES II
2000	6	HERMETIC SEAL CORP.	MIL-C-5015
2000	19	HERMETIC SEAL CORP.	MIL-C-83723 SERIES II
208	6	AMPHENOL	MIL-C-5015
208	19	AMPHENOL	MIL-C-83723 SERIES II
229	8	AMPHENOL	MIL-C-22992 CLASS L
238	6	AMPHENOL	MIL-C-5015
238	19	AMPHENOL	MIL-C-83723 SERIES II
246	6	AMPHENOL	MIL-C-5015
246	19	AMPHENOL	MIL-C-83723 SERIES II
26500	10	CONNECTOR INDUSTRIES	MIL-C-26500

PREFIX	PAGE	MANUFACTURER	CONNECTOR SERIES (REFERENCE)
26500	10	ELECTRONIC	MIL-C-26500
26500	10	HERMETIC SEAL CORP.	MIL-C-26500
348	16	AMPHENOL	MIL-C-81511 SERIES 1 & 3
348	17	AMPHENOL	MIL-C-81511 SERIES 2 & 4
416	12	AMPHENOL	MIL-C-38999 SERIES I
418	13	AMPHENOL	MIL-C-38999 SERIES II
450	9	DEUTSCH	MIL-C-26482 SERIES 1 & 2
450	18	DEUTSCH	MIL-C-83723 SERIES I
460	9	DEUTSCH	MIL-C-26482 SERIES 1 & 2
460	18	DEUTSCH	MIL-C-83723 SERIES I
48	10	AMPHENOL	MIL-C-26500
48	20	AMPHENOL	MIL-C-83723 SERIES III
48-7005	10	AMPHENOL	MIL-C-26500
50	10	GLASSEAL	MIL-C-26500
50	20	GLASSEAL	MIL-C-83723 SERIES III
5015	6	BENDIX	MIL-C-5015
5015	6	ELECTRONIC SEALS	MIL-C-5015
5015	19	BENDIX	MIL-C-83723 SERIES II
5015	19	ELECTRONIC SEALS	MIL-C-83723 SERIES II
518	10	AMPHENOL	MIL-C-26500
518	20	AMPHENOL	MIL-C-83723 SERIES III
5388	12	BENDIX	MIL-C-38999 SERIES I
5565	14	BENDIX	MIL-C-38999 SERIES III
6000	6	SEALTRON	MIL-C-5015
6000	19	SEALTRON	MIL-C-83723 SERIES II
602GB	21	AMPHENOL	PATTERN 602
6300	9	SEALTRON	MIL-C-26482 SERIES 1 & 2
6300	18	SEALTRON	MIL-C-83723 SERIES I
6500	10	SEALTRON	MIL-C-26500
6500	20	SEALTRON	MIL-C-83723 SERIES III
6600	10	SEALTRON	MIL-C-26500
6600	20	SEALTRON	MIL-C-83723 SERIES III
69	6	AMPHENOL	MIL-C-5015
69	19	AMPHENOL	MIL-C-83723 SERIES II
700	12	GLASSEAL	MIL-C-38999 SERIES I
7000	9	HERMETIC SEAL CORP.	MIL-C-26482 SERIES 1 & 2
7000	18	HERMETIC SEAL CORP.	MIL-C-83723 SERIES I
72	6	AMPHENOL	MIL-C-5015

PREFIX	PAGE	MANUFACTURER	CONNECTOR SERIES (REFERENCE)
72	19	AMPHENOL	MIL-C-83723 SERIES II
75	6	VEAM/LITTON	MIL-C-5015
75	19	VEAM/LITTON	MIL-C-83723 SERIES II
800	13	GLASSEAL	MIL-C-38999 SERIES II
8000	6	SEALTRON	MIL-C-5015
8000	19	SEALTRON	MIL-C-83723 SERIES II
810	9	DEUTSCH	MIL-C-26482 SERIES 1 & 2
810	18	DEUTSCH	MIL-C-83723 SERIES I
8100	9	SEALTRON	MIL-C-26482 SERIES 1 & 2
8100	18	SEALTRON	MIL-C-83723 SERIES I
815	16	DEUTSCH	MIL-C-81511 SERIES 1 & 3
815	17	DEUTSCH	MIL-C-81511 SERIES 2 & 4
8300	9	SEALTRON	MIL-C-26482 SERIES 1 & 2
8300	18	SEALTRON	MIL-C-83723 SERIES I
83723	20	HERMETIC SEAL CORP.	MIL-C-83723 SERIES III
83723	20	SOURIAU	MIL-C-83723 SERIES III
83723 III	20	CONNECTOR INDUSTRIES	MIL-C-83723 SERIES III
8500	10	SEALTRON	MIL-C-26500
851	9	SOURIAU	MIL-C-26482 SERIES 1 & 2
851	18	SOURIAU	MIL-C-83723 SERIES I
851*R	9	SOURIAU	MIL-C-26482 SERIES 1 & 2
851*R	18	SOURIAU	MIL-C-83723 SERIES I
8526	9	SOURIAU	MIL-C-26482 SERIES 1 & 2
8526	18	SOURIAU	MIL-C-83723 SERIES I
8526	21	SOURIAU	PATTERN 602
8530	10	SOURIAU	MIL-C-26500
8530	20	SOURIAU	MIL-C-83723 SERIES III
8600	10	SEALTRON	MIL-C-26500
88-194	7	BENDIX	MIL-C-22992 CLASSES C, J, R
880	9	DEUTSCH	MIL-C-26482 SERIES 1 & 2
880	18	DEUTSCH	MIL-C-83723 SERIES I
8LT	12	SOURIAU	MIL-C-38999 SERIES I
IT	13	SOURIAU	MIL-C-38999 SERIES II
9—	9	ELECTRONIC SEALS	MIL-C-26482 SERIES 1 & 2
9—	18	ELECTRONIC SEALS	MIL-C-83723 SERIES I
900000	12	HERMETIC SEAL CORP.	MIL-C-38999 SERIES I
900000	13	HERMETIC SEAL CORP.	MIL-C-38999 SERIES II
944	6	MATRIX SCIENCE	MIL-C-5015

CONNECTOR IDENTIFICATION

PREFIX	PAGE	MANUFACTURER	CONNECTOR SERIES (REFERENCE)
944	19	MATRIX SCIENCE	MIL-C-83723 SERIES II
94603	10	DEUTSCH	MIL-C-26500
94603	20	DEUTSCH	MIL-C-83723 SERIES III
97	6	AMPHENOL	MIL-C-5015
97	19	AMPHENOL	MIL-C-83723 SERIES II
9700	12	SEALTRON	MIL-C-38999 SERIES I
9800	13	SEALTRON	MIL-C-38999 SERIES II
981	6	MATRIX SCIENCE	MIL-C-5015
981	19	MATRIX SCIENCE	MIL-C-83723 SERIES II
9900	14	SEALTRON	MIL-C-38999 SERIES III
A	6	CONNECTOR INDUSTRIES	MIL-C-5015
A	19	CONNECTOR INDUSTRIES	MIL-C-83723 SERIES II
AE55	6	AERO ELECTRIC	MIL-C-5015
AE55	19	AERO ELECTRIC	MIL-C-83723 SERIES II
AE723	6	AERO ELECTRIC	MIL-C-5015
AE723	19	AERO ELECTRIC	MIL-C-83723 SERIES II
AE77	9	AERO ELECTRIC	MIL-C-26482 SERIES 1 & 2
AE77	18	AERO ELECTRIC	MIL-C-83723 SERIES I
AFD	9	DEUTSCH	MIL-C-26482 SERIES 1 & 2
AFD	18	DEUTSCH	MIL-C-83723 SERIES I
B	10	PYLE-NATIONAL	MIL-C-26500
B	20	PYLE-NATIONAL	MIL-C-83723 SERIES III
B555	8	BURNDY	MIL-C-22992 CLASS L
B556	8	BURNDY	MIL-C-22992 CLASS L
B557	8	BURNDY	MIL-C-22992 CLASS L
B558	8	BURNDY	MIL-C-22992 CLASS L
BACC45F	10	BOEING	MIL-C-26500
BACC45F	20	BOEING	MIL-C-83723 SERIES III
BACC63	10	BOEING	MIL-C-26500
BE	9	GLASSEAL	MIL-C-26482 SERIES 1 & 2
BE	18	GLASSEAL	MIL-C-83723 SERIES I
BFH	6	ITT CANNON	MIL-C-5015
BFH	10	PYLE-NATIONAL	MIL-C-26500
BFH	19	ITT CANNON	MIL-C-83723 SERIES II
BFH	20	PYLE-NATIONAL	MIL-C-83723 SERIES III
BFR	6	ITT CANNON	MIL-C-5015
BFR	19	ITT CANNON	MIL-C-83723 SERIES II
BL	15	G & H TECHNOLOGY	MIL-C-38999 SERIES IV
BT	9	BURNDY	MIL-C-26482 SERIES 1 & 2
BT	18	BURNDY	MIL-C-83723 SERIES I
BT-M	6	BENDIX	MIL-C-5015
BT-M	19	BENDIX	MIL-C-83723 SERIES II
BT-RA	6	BENDIX	MIL-C-5015
BT-RA	19	BENDIX	MIL-C-83723 SERIES II

PREFIX	PAGE	MANUFACTURER	CONNECTOR SERIES (REFERENCE)
C	9	CONNECTOR INDUSTRIES	MIL-C-26482 SERIES 1 & 2
C	18	CONNECTOR INDUSTRIES	MIL-C-83723 SERIES I
C48	10	TRW	MIL-C-26500
CA	6	ITT CANNON	MIL-C-5015
CA	19	ITT CANNON	MIL-C-83723 SERIES II
CA-EA	6	ITT CANNON	MIL-C-5015
CA-EA	19	ITT CANNON	MIL-C-83723 SERIES II
CA-EB	6	ITT CANNON	MIL-C-5015
CA-EB	19	ITT CANNON	MIL-C-83723 SERIES II
CA-HR	6	ITT CANNON	MIL-C-5015
CA-HR	19	ITT CANNON	MIL-C-83723 SERIES II
CA-KE	6	ITT CANNON	MIL-C-5015
CA-KE	19	ITT CANNON	MIL-C-83723 SERIES II
CA-RX	6	ITT CANNON	MIL-C-5015
CA-RX	19	ITT CANNON	MIL-C-83723 SERIES II
CN	15	TRW	MIL-C-38999 SERIES IV
CN0915	10	TRW	MIL-C-26500
CN0930	10	TRW	MIL-C-26500
CN0930	20	TRW	MIL-C-83723 SERIES III
CN0942	10	TRW	MIL-C-26500
CN0966	10	TRW	MIL-C-26500
CN0966	20	TRW	MIL-C-83723 SERIES III
CN0967	10	TRW	MIL-C-26500
CN0967	20	TRW	MIL-C-83723 SERIES III
CT	12	PLESSEY	MIL-C-38999 SERIES I
CT	13	PLESSEY	MIL-C-38999 SERIES II
CTC	12	DEUTSCH	MIL-C-38999 SERIES I
CV	6	ITT CANNON	MIL-C-5015
CV	19	ITT CANNON	MIL-C-83723 SERIES II
CVA	6	ITT CANNON	MIL-C-5015
CVA	19	ITT CANNON	MIL-C-83723 SERIES II
CWLD	7	ITT CANNON	MIL-C-22992 CLASSES C, J, R
D38999/20	14	MILITARY	MIL-C-38999 SERIES III
D38999/21	14	MILITARY	MIL-C-38999 SERIES III
D38999/23	14	MILITARY	MIL-C-38999 SERIES III
D38999/24	14	MILITARY	MIL-C-38999 SERIES III
D38999/25	14	MILITARY	MIL-C-38999 SERIES III
D38999/26	14	MILITARY	MIL-C-38999 SERIES III
D38999/27	14	MILITARY	MIL-C-38999 SERIES III
D38999/29	14	MILITARY	MIL-C-38999 SERIES III
D38999/30	14	MILITARY	MIL-C-38999 SERIES III
D38999/31	14	MILITARY	MIL-C-38999 SERIES III
D38999/40	14	MILITARY	MIL-C-38999 SERIES III
D38999/41	14	MILITARY	MIL-C-38999 SERIES III
D38999/42	14	MILITARY	MIL-C-38999 SERIES III
D38999/43	14	MILITARY	MIL-C-38999 SERIES III
D38999/44	14	MILITARY	MIL-C-38999 SERIES III
D38999/45	14	MILITARY	MIL-C-38999 SERIES III
D38999/46	14	MILITARY	MIL-C-38999 SERIES III
D38999/47	14	MILITARY	MIL-C-38999 SERIES III
D38999/48	14	MILITARY	MIL-C-38999 SERIES III
D38999/49	14	MILITARY	MIL-C-38999 SERIES III
DB	10	DEUTSCH	MIL-C-26500

PREFIX	PAGE	MANUFACTURER	CONNECTOR SERIES (REFERENCE)
DB	20	DEUTSCH	MIL-C-83723 SERIES III
DBC	9	DEUTSCH	MIL-C-26482 SERIES 1 & 2
DBC	18	DEUTSCH	MIL-C-83723 SERIES I
DC	9	BENDIX	MIL-C-26482 SERIES 1 & 2
DC	18	BENDIX	MIL-C-83723 SERIES I
DIV	15	DEUTSCH	MIL-C-38999 SERIES IV
DJT	12	DEUTSCH	MIL-C-38999 SERIES I
DJT	13	DETORONICS	MIL-C-38999 SERIES II
DL	10	DEUTSCH	MIL-C-26500
DL	20	DEUTSCH	MIL-C-83723 SERIES III
DS	6	DETORONICS	MIL-C-5015
DS	19	DETORONICS	MIL-C-83723 SERIES II
DT	9	DETORONICS	MIL-C-26482 SERIES 1 & 2
DT	18	DETORONICS	MIL-C-83723 SERIES I
DTS	14	DEUTSCH	MIL-C-38999 SERIES III
DX	10	DETORONICS	MIL-C-26500
DX	20	DETORONICS	MIL-C-83723 SERIES III
EX-A	6	ITT CANNON	MIL-C-5015
EX-A	19	ITT CANNON	MIL-C-83723 SERIES II
F	10	PYLE-NATIONAL	MIL-C-26500
FC	6	FLIGHT CONNECTOR	MIL-C-5015
FC	19	FLIGHT CONNECTOR	MIL-C-83723 SERIES II
FF0	6	FLIGHT CONNECTOR	MIL-C-5015
FF0	19	FLIGHT CONNECTOR	MIL-C-83723 SERIES II
FF5	6	FLIGHT CONNECTOR	MIL-C-5015
FF5	19	FLIGHT CONNECTOR	MIL-C-83723 SERIES II
FH	6	FLIGHT CONNECTOR	MIL-C-5015
FH	19	FLIGHT CONNECTOR	MIL-C-83723 SERIES II
FPT(21-)	9	BENDIX	MIL-C-26482 SERIES 1 & 2
FPT(21-)	18	BENDIX	MIL-C-83723 SERIES I
FRA	6	ITT CANNON	MIL-C-5015
FRA	19	ITT CANNON	MIL-C-83723 SERIES II
FRF	6	ITT CANNON	MIL-C-5015
FRF	19	ITT CANNON	MIL-C-83723 SERIES II
FVA	6	ITT CANNON	MIL-C-5015
FVA	19	ITT CANNON	MIL-C-83723 SERIES II
FVF	6	ITT CANNON	MIL-C-5015
FVF	19	ITT CANNON	MIL-C-83723 SERIES II
FW	6	ITT CANNON	MIL-C-5015
FW	19	ITT CANNON	MIL-C-83723 SERIES II
FZC	6	FLIGHT CONNECTOR	MIL-C-5015
FZC	19	FLIGHT CONNECTOR	MIL-C-83723 SERIES II
FZH	6	FLIGHT CONNECTOR	MIL-C-5015
FZH	19	FLIGHT CONNECTOR	MIL-C-83723 SERIES II
G	12	CONNECTOR INDUSTRIES	MIL-C-38999 SERIES I

PREFIX	PAGE	MANUFACTURER	CONNECTOR SERIES (REFERENCE)
G	13	CONNECTOR INDUSTRIES	MIL-C-38999 SERIES II
GB	9	GLASSEAL	MIL-C-26482 SERIES 1 & 2
GB	18	GLASSEAL	MIL-C-83723 SERIES I
GC	9	GENERAL CONNECTOR	MIL-C-26482 SERIES 1 & 2
GC	18	GENERAL CONNECTOR	MIL-C-83723 SERIES I
GC*C	9	GENERAL CONNECTOR	MIL-C-26482 SERIES 1 & 2
GC*C	18	GENERAL CONNECTOR	MIL-C-83723 SERIES I
GS	6	ITT CANNON	MIL-C-5015
GS	11	HUGHES	MIL-C-28840
GS	19	ITT CANNON	MIL-C-83723 SERIES II
GSP	6	GLASSEAL	MIL-C-5015
GSP	19	GLASSEAL	MIL-C-83723 SERIES II
GT	11	HUGHES	MIL-C-28840
H	13	CONNECTOR INDUSTRIES	MIL-C-38999 SERIES II
HD	11	IPI (SAE)	MIL-C-28840
HK	7	BENDIX	MIL-C-22992 CLASSES C, J, R
HM SERIES	12	IPI (SAE)	MIL-C-38999 SERIES I
HM SERIES	13	IPI (SAE)	MIL-C-38999 SERIES II
HS06	6	HERMETIC SEAL CORP.	MIL-C-5015
HS06	19	HERMETIC SEAL CORP.	MIL-C-83723 SERIES II
HT	6	BENDIX	MIL-C-5015
HT	19	BENDIX	MIL-C-83723 SERIES II
HTMF	10	ITT CANNON	MIL-C-26500
HTMF	20	ITT CANNON	MIL-C-83723 SERIES III
JT	13	BENDIX	MIL-C-38999 SERIES II
K	9	CONNECTOR INDUSTRIES	MIL-C-26482 SERIES 1 & 2
K	18	CONNECTOR INDUSTRIES	MIL-C-83723 SERIES I
KFS	11	ITT CANNON	MIL-C-28840
KJ	13	ITT CANNON	MIL-C-38999 SERIES II
KJA	14	ITT CANNON	MIL-C-38999 SERIES III
KJJ	13	ITT CANNON	MIL-C-38999 SERIES II
KJL	12	ITT CANNON	MIL-C-38999 SERIES I
KJL	12	ITT CANNON	MIL-C-38999 SERIES I
KP*	9	ITT CANNON	MIL-C-26482 SERIES 1 & 2
KP*	18	ITT CANNON	MIL-C-83723 SERIES I
KPD	9	ITT CANNON	MIL-C-26482 SERIES 1 & 2
KPD	18	ITT CANNON	MIL-C-83723 SERIES I
KPSE	9	ITT CANNON	MIL-C-26482 SERIES 1 & 2
KPSE	18	ITT CANNON	MIL-C-83723 SERIES I
KPT	9	ITT CANNON	MIL-C-26482 SERIES 1 & 2
KPT	18	ITT CANNON	MIL-C-83723 SERIES I
KPTM	9	ITT CANNON	MIL-C-26482 SERIES 1 & 2
KPTM	18	ITT CANNON	MIL-C-83723 SERIES I
KS*	9	ITT CANNON	MIL-C-26482 SERIES 1 & 2
KS*	18	ITT CANNON	MIL-C-83723 SERIES I
KSP	9	ITT CANNON	MIL-C-26482 SERIES 1 & 2

PREFIX	PAGE	MANUFACTURER	CONNECTOR SERIES (REFERENCE)
KSP	18	ITT CANNON	MIL-C-83723 SERIES I
KSPM	9	ITT CANNON	MIL-C-26482 SERIES 1 & 2
KSPM	18	ITT CANNON	MIL-C-83723 SERIES I
KSSE	9	ITT CANNON	MIL-C-26482 SERIES 1 & 2
KSSE	18	ITT CANNON	MIL-C-83723 SERIES I
L*T	9	BURNDY	MIL-C-26482 SERIES 1 & 2
L*T	18	BURNDY	MIL-C-83723 SERIES I
LCT	12	PLESSEY	MIL-C-38999 SERIES I
LJT	12	BENDIX	MIL-C-38999 SERIES I
LM*C	6	BURNDY	MIL-C-5015
LM*C	19	BURNDY	MIL-C-83723 SERIES II
M0	6	IPI (SEA)	MIL-C-5015
M0	19	IPI (SAE)	MIL-C-83723 SERIES II
M28840/10	11	MILITARY	MIL-C-28840
M28840/11	11	MILITARY	MIL-C-28840
M28840/12	11	MILITARY	MIL-C-28840
M28840/16	11	MILITARY	MIL-C-28840
M28840/16	11	MILITARY	MIL-C-28840
M28840/17	11	MILITARY	MIL-C-28840
M28840/18	11	MILITARY	MIL-C-28840
M28840/19	11	MILITARY	MIL-C-28840
M28840/20	11	MILITARY	MIL-C-28840
M28840/21	11	MILITARY	MIL-C-28840
M28840/26	11	MILITARY	MIL-C-28840
M28840/28	11	MILITARY	MIL-C-28840
M28840/29	11	MILITARY	MIL-C-28840
M5	6	IPI (SAE)	MIL-C-5015
M5	19	IPI (SAE)	MIL-C-83723 SERIES II
M723	6	MATRIX SCIENCE	MIL-C-5015
M723	19	MATRIX SCIENCE	MIL-C-83723 SERIES II
M81511/01	17	MILITARY	MIL-C-81511 SERIES 2 & 4
M81511/02	17	MILITARY	MIL-C-81511 SERIES 2 & 4
M81511/03	17	MILITARY	MIL-C-81511 SERIES 2 & 4
M81511/04	17	MILITARY	MIL-C-81511 SERIES 2 & 4
M81511/05	17	MILITARY	MIL-C-81511 SERIES 2 & 4
M81511/06	17	MILITARY	MIL-C-81511 SERIES 2 & 4
M81511/21	16	MILITARY	MIL-C-81511 SERIES 1 & 3
M81511/22	16	MILITARY	MIL-C-81511 SERIES 1 & 3
M81511/23	16	MILITARY	MIL-C-81511 SERIES 1 & 3
M81511/24	16	MILITARY	MIL-C-81511 SERIES 1 & 3
M81511/25	16	MILITARY	MIL-C-81511 SERIES 1 & 3
M81511/26	16	MILITARY	MIL-C-81511 SERIES 1 & 3
M81511/27	16	MILITARY	MIL-C-81511 SERIES 1 & 3
M81511/28	17	MILITARY	MIL-C-81511 SERIES 2 & 4
M81511/31	17	MILITARY	MIL-C-81511 SERIES 2 & 4
M81511/32	17	MILITARY	MIL-C-81511 SERIES 2 & 4
M81511/33	17	MILITARY	MIL-C-81511 SERIES 2 & 4
M81511/34	17	MILITARY	MIL-C-81511 SERIES 2 & 4
M81511/35	16	MILITARY	MIL-C-81511 SERIES 1 & 3
M81511/36	16	MILITARY	MIL-C-81511 SERIES 1 & 3
M81511/37	16	MILITARY	MIL-C-81511 SERIES 1 & 3
M81511/38	16	MILITARY	MIL-C-81511 SERIES 1 & 3
M81511/41	16	MILITARY	MIL-C-81511 SERIES 1 & 3

PREFIX	PAGE	MANUFACTURER	CONNECTOR SERIES (REFERENCE)
M81511/42	16	MILITARY	MIL-C-81511 SERIES 1 & 3
M81511/44	16	MILITARY	MIL-C-81511 SERIES 1 & 3
M81511/45	16	MILITARY	MIL-C-81511 SERIES 1 & 3
M81511/46	16	MILITARY	MIL-C-81511 SERIES 1 & 3
M81511/47	16	MILITARY	MIL-C-81511 SERIES 1 & 3
M81511/48	16	MILITARY	MIL-C-81511 SERIES 1 & 3
M81511/49	16	MILITARY	MIL-C-81511 SERIES 1 & 3
M81511/50	17	MILITARY	MIL-C-81511 SERIES 2 & 4
M81511/51	17	MILITARY	MIL-C-81511 SERIES 2 & 4
M81511/52	17	MILITARY	MIL-C-81511 SERIES 2 & 4
M81511/53	17	MILITARY	MIL-C-81511 SERIES 2 & 4
M81511/54	17	MILITARY	MIL-C-81511 SERIES 2 & 4
M81511/55	17	MILITARY	MIL-C-81511 SERIES 2 & 4
M81511/56	17	MILITARY	MIL-C-81511 SERIES 2 & 4
M81511/57	17	MILITARY	MIL-C-81511 SERIES 2 & 4
M83723/01	18	MILITARY	MIL-C-83723 SERIES I
M83723/02	18	MILITARY	MIL-C-83723 SERIES I
M83723/03	18	MILITARY	MIL-C-83723 SERIES I
M83723/04	18	MILITARY	MIL-C-83723 SERIES I
M83723/05	18	MILITARY	MIL-C-83723 SERIES I
M83723/06	18	MILITARY	MIL-C-83723 SERIES I
M83723/07	18	MILITARY	MIL-C-83723 SERIES I
M83723/08	18	MILITARY	MIL-C-83723 SERIES I
M83723/09	18	MILITARY	MIL-C-83723 SERIES I
M83723/10	18	MILITARY	MIL-C-83723 SERIES I
M83723/11	18	MILITARY	MIL-C-83723 SERIES I
M83723/12	18	MILITARY	MIL-C-83723 SERIES I
M83723/13	18	MILITARY	MIL-C-83723 SERIES I
M83723/16	18	MILITARY	MIL-C-83723 SERIES I
M83723/17	19	MILITARY	MIL-C-83723 SERIES II
M83723/18	19	MILITARY	MIL-C-83723 SERIES II
M83723/19	19	MILITARY	MIL-C-83723 SERIES II
M83723/20	19	MILITARY	MIL-C-83723 SERIES II
M83723/21	19	MILITARY	MIL-C-83723 SERIES II
M83723/22	19	MILITARY	MIL-C-83723 SERIES II
M83723/23	19	MILITARY	MIL-C-83723 SERIES II
M83723/24	19	MILITARY	MIL-C-83723 SERIES II
M83723/25	19	MILITARY	MIL-C-83723 SERIES II
M83723/26	19	MILITARY	MIL-C-83723 SERIES II
M83723/36	18	MILITARY	MIL-C-83723 SERIES I
M83723/37	18	MILITARY	MIL-C-83723 SERIES I
M83723/38	18	MILITARY	MIL-C-83723 SERIES I
M83723/39	18	MILITARY	MIL-C-83723 SERIES I
M83723/40	18	MILITARY	MIL-C-83723 SERIES I
M83723/41	18	MILITARY	MIL-C-83723 SERIES I
M83723/42	18	MILITARY	MIL-C-83723 SERIES I
M83723/43	18	MILITARY	MIL-C-83723 SERIES I
M83723/48	18	MILITARY	MIL-C-83723 SERIES I
M83723/49	18	MILITARY	MIL-C-83723 SERIES I
M83723/52	19	MILITARY	MIL-C-83723 SERIES II
M83723/53	19	MILITARY	MIL-C-83723 SERIES II
M83723/65	20	MILITARY	MIL-C-83723 SERIES III
M83723/66	20	MILITARY	MIL-C-83723 SERIES III
M83723/67	20	MILITARY	MIL-C-83723 SERIES III
M83723/68	20	MILITARY	MIL-C-83723 SERIES III

CONNECTOR IDENTIFICATION

PREFIX	PAGE	MANUFACTURER	CONNECTOR SERIES (REFERENCE)
M83723/69	20	MILITARY	MIL-C-83723 SERIES III
M83723/71	20	MILITARY	MIL-C-83723 SERIES III
M83723/72	20	MILITARY	MIL-C-83723 SERIES III
M83723/73	20	MILITARY	MIL-C-83723 SERIES III
M83723/74	20	MILITARY	MIL-C-83723 SERIES III
M83723/75	20	MILITARY	MIL-C-83723 SERIES III
M83723/76	20	MILITARY	MIL-C-83723 SERIES III
M83723/77	20	MILITARY	MIL-C-83723 SERIES III
M83723/78	20	MILITARY	MIL-C-83723 SERIES III
M83723/79	20	MILITARY	MIL-C-83723 SERIES III
M83723/80	20	MILITARY	MIL-C-83723 SERIES III
M83723/81	20	MILITARY	MIL-C-83723 SERIES III
M83723/82	20	MILITARY	MIL-C-83723 SERIES III
M83723/83	20	MILITARY	MIL-C-83723 SERIES III
M83723/84	20	MILITARY	MIL-C-83723 SERIES III
M83723/85	20	MILITARY	MIL-C-83723 SERIES III
M83723/86	20	MILITARY	MIL-C-83723 SERIES III
M83723/87	20	MILITARY	MIL-C-83723 SERIES III
M83723/88	20	MILITARY	MIL-C-83723 SERIES III
M83723/89	20	MILITARY	MIL-C-83723 SERIES III
M83723/90	20	MILITARY	MIL-C-83723 SERIES III
M83723/91	20	MILITARY	MIL-C-83723 SERIES III
M83723/92	20	MILITARY	MIL-C-83723 SERIES III
M83723/93	20	MILITARY	MIL-C-83723 SERIES III
M83723/94	20	MILITARY	MIL-C-83723 SERIES III
M83723/95	20	MILITARY	MIL-C-83723 SERIES III
M83723/96	20	MILITARY	MIL-C-83723 SERIES III
M83723/97	20	MILITARY	MIL-C-83723 SERIES III
M83723/98	20	MILITARY	MIL-C-83723 SERIES III
MB1	9	MATRIX SCIENCE	MIL-C-26482 SERIES 1 & 2
MB1	18	MATRIX SCIENCE	MIL-C-83723 SERIES I
MB3	10	MATRIX SCIENCE	MIL-C-26500
MB3	20	MATRIX SCIENCE	MIL-C-83723 SERIES III
MB91	12	MATRIX SCIENCE	MIL-C-38999 SERIES I
MB92	13	MATRIX SCIENCE	MIL-C-38999 SERIES II
MFR	6	MATRIX SCIENCE	MIL-C-5015
MFR	19	MATRIX SCIENCE	MIL-C-83723 SERIES II
MHD	8	MATRIX SCIENCE	MIL-C-22992 CLASS L
ML94	15	MATRIX SCIENCE	MIL-C-38999 SERIES IV
MMB	10	TRW	MIL-C-26500
MR	6	ITT CANNON	MIL-C-5015
MR	19	ITT CANNON	MIL-C-83723 SERIES II
MS17343	7	MILITARY	MIL-C-22992 CLASSES C, J, R

PREFIX	PAGE	MANUFACTURER	CONNECTOR SERIES (REFERENCE)
MS17344	7	MILITARY	MIL-C-22992 CLASSES C, J, R
MS17345	7	MILITARY	MIL-C-22992 CLASSES C, J, R
MS17346	7	MILITARY	MIL-C-22992 CLASSES C, J, R
MS17347	7	MILITARY	MIL-C-22992 CLASSES C, J, R
MS17348	7	MILITARY	MIL-C-22992 CLASSES C, J, R
MS24264	10	MILITARY	MIL-C-26500
MS24265	10	MILITARY	MIL-C-26500
MS24266	10	MILITARY	MIL-C-26500
MS24183	6	MILITARY	MIL-C-5015
MS25183A	6	MILITARY	MIL-C-5015
MS27034	10	MILITARY	MIL-C-26500
MS27466	12	MILITARY	MIL-C-38999 SERIES I
MS27467	12	MILITARY	MIL-C-38999 SERIES I
MS27468	12	MILITARY	MIL-C-38999 SERIES I
MS27469	12	MILITARY	MIL-C-38999 SERIES I
MS27470	12	MILITARY	MIL-C-38999 SERIES I
MS27471	12	MILITARY	MIL-C-38999 SERIES I
MS27472	13	MILITARY	MIL-C-38999 SERIES II
MS27473	13	MILITARY	MIL-C-38999 SERIES II
MS27474	13	MILITARY	MIL-C-38999 SERIES II
MS27475	13	MILITARY	MIL-C-38999 SERIES II
MS27476	13	MILITARY	MIL-C-38999 SERIES II
MS27477	13	MILITARY	MIL-C-38999 SERIES II
MS27478	13	MILITARY	MIL-C-38999 SERIES II
MS27479	13	MILITARY	MIL-C-38999 SERIES II
MS27480	13	MILITARY	MIL-C-38999 SERIES II
MS27481	13	MILITARY	MIL-C-38999 SERIES II
MS27482	13	MILITARY	MIL-C-38999 SERIES II
MS27483	13	MILITARY	MIL-C-38999 SERIES II
MS27484	13	MILITARY	MIL-C-38999 SERIES II
MS27496	12	MILITARY	MIL-C-38999 SERIES I
MS27497	13	MILITARY	MIL-C-38999 SERIES II
MS27498	12	MILITARY	MIL-C-38999 SERIES I
MS27499	13	MILITARY	MIL-C-38999 SERIES II
MS27500	13	MILITARY	MIL-C-38999 SERIES II
MS27503	13	MILITARY	MIL-C-38999 SERIES II
MS27504	13	MILITARY	MIL-C-38999 SERIES II
MS27505	12	MILITARY	MIL-C-38999 SERIES I
MS27508	13	MILITARY	MIL-C-38999 SERIES II
MS27513	13	MILITARY	MIL-C-38999 SERIES II
MS27515	12	MILITARY	MIL-C-38999 SERIES I
MS27613	10	MILITARY	MIL-C-26500
MS27616	10	MILITARY	MIL-C-26500
MS27615	10	MILITARY	MIL-C-26500
MS27652	12	MILITARY	MIL-C-38999 SERIES I

PREFIX	PAGE	MANUFACTURER	CONNECTOR SERIES (REFERENCE)
MS27653	12	MILITARY	MIL-C-38999 SERIES I
MS27654	12	MILITARY	MIL-C-38999 SERIES I
MS27656	12	MILITARY	MIL-C-38999 SERIES I
MS27661	12	MILITARY	MIL-C-38999 SERIES I
MS27662	12	MILITARY	MIL-C-38999 SERIES I
MS27664	13	MILITARY	MIL-C-38999 SERIES II
MS3100	6	MILITARY	MIL-C-5015
MS3101	6	MILITARY	MIL-C-5015
MS3102	6	MILITARY	MIL-C-5015
MS3103	6	MILITARY	MIL-C-5015
MS3106	6	MILITARY	MIL-C-5015
MS3107	6	MILITARY	MIL-C-5015
MS3108	6	MILITARY	MIL-C-5015
MS3120	9	MILITARY	MIL-C-26482 SERIES 1 & 2
MS3121	9	MILITARY	MIL-C-26482 SERIES 1 & 2
MS3122	9	MILITARY	MIL-C-26482 SERIES 1 & 2
MS3124	9	MILITARY	MIL-C-26482 SERIES 1 & 2
MS3126	9	MILITARY	MIL-C-26482 SERIES 1 & 2
MS3127	9	MILITARY	MIL-C-26482 SERIES 1 & 2
MS3128	9	MILITARY	MIL-C-26482 SERIES 1 & 2
MS3142	6	MILITARY	MIL-C-5015
MS3143	6	MILITARY	MIL-C-5015
MS3400	6	MILITARY	MIL-C-5015
MS3401	6	MILITARY	MIL-C-5015
MS3402	6	MILITARY	MIL-C-5015
MS3404	6	MILITARY	MIL-C-5015
MS3406	6	MILITARY	MIL-C-5015
MS3408	6	MILITARY	MIL-C-5015
MS3409	6	MILITARY	MIL-C-5015
MS3412	6	MILITARY	MIL-C-5015
MS3436	6	MILITARY	MIL-C-5015
MS3440	9	MILITARY	MIL-C-26482 SERIES 1 & 2
MS3442	9	MILITARY	MIL-C-26482 SERIES 1 & 2
MS3443	9	MILITARY	MIL-C-26482 SERIES 1 & 2
MS3447	9	MILITARY	MIL-C-26482 SERIES 1 & 2
MS3450	6	MILITARY	MIL-C-5015
MS3451	6	MILITARY	MIL-C-5015
MS3452	6	MILITARY	MIL-C-5015
MS3454	6	MILITARY	MIL-C-5015
MS3456	6	MILITARY	MIL-C-5015
MS3459	6	MILITARY	MIL-C-5015
MS3470	9	MILITARY	MIL-C-26482 SERIES 1 & 2
MS3471	9	MILITARY	MIL-C-26482 SERIES 1 & 2
MS3472	9	MILITARY	MIL-C-26482 SERIES 1 & 2
MS3473	9	MILITARY	MIL-C-26482 SERIES 1 & 2
MS3474	9	MILITARY	MIL-C-26482 SERIES 1 & 2
MS3475	9	MILITARY	MIL-C-26482 SERIES 1 & 2

PREFIX	PAGE	MANUFACTURER	CONNECTOR SERIES (REFERENCE)
MS3476	9	MILITARY	MIL-C-26482 SERIES 1 & 2
MS3477	9	MILITARY	MIL-C-26482 SERIES 1 & 2
MS3479	9	MILITARY	MIL-C-26482 SERIES 1 & 2
MS3507	6	MILITARY	MIL-C-5015
MS90555	8	MILITARY	MIL-C-22992 CLASS L
MS90556	8	MILITARY	MIL-C-22992 CLASS L
MS90557	8	MILITARY	MIL-C-22992 CLASS L
MS90558	8	MILITARY	MIL-C-22992 CLASS L
MT3	10	MATRIX SCIENCE	MIL-C-26500
MT3	20	MATRIX SCIENCE	MIL-C-83723 SERIES III
MT93	14	MATRIX SCIENCE	MIL-C-38999 SERIES III
NC	11	G & H TECHNOLOGY	MIL-C-28840
P	12	CONNECTOR INDUSTRIES	MIL-C-38999 SERIES I
PL	15	FLIGHT CONNECTOR	MIL-C-38999 SERIES IV
PT	9	BENDIX	MIL-C-26482 SERIES 1 & 2
PT	18	BENDIX	MIL-C-83723 SERIES I
PT*CE	9	BENDIX	MIL-C-26482 SERIES 1 & 2
PT*CE	18	BENDIX	MIL-C-83723 SERIES I
PT*SE	9	BENDIX	MIL-C-26482 SERIES 1 & 2
PT*SE	18	BENDIX	MIL-C-83723 SERIES I
PTS*DR	9	BENDIX	MIL-C-26482 SERIES 1 & 2
PTS*DR	18	BENDIX	MIL-C-83723 SERIES I
PV	9	ITT CANNON	MIL-C-26482 SERIES 1 & 2
PV	18	ITT CANNON	MIL-C-83723 SERIES I
PVA	9	ITT CANNON	MIL-C-26482 SERIES 1 & 2
PVA	18	ITT CANNON	MIL-C-83723 SERIES I
PVJ	9	ITT CANNON	MIL-C-26482 SERIES 1 & 2
PVJ	18	ITT CANNON	MIL-C-83723 SERIES I

PREFIX	PAGE	MANUFACTURER	CONNECTOR SERIES (REFERENCE)
PVW	9	ITT CANNON	MIL-C-26482 SERIES 1 & 2
PVW	18	ITT CANNON	MIL-C-83723 SERIES I
PVX	9	ITT CANNON	MIL-C-26482 SERIES 1 & 2
PVX	18	ITT CANNON	MIL-C-83723 SERIES I
PVX	21	CANNON ELECTRIC GB	PATTERN 602
PW	9	S.E.C.	MIL-C-26482 SERIES 1 & 2
PW	18	S.E.C.	MIL-C-83723 SERIES I
QWLD	7	BENDIX	MIL-C-22992 CLASSES C, J, R
RBC	9	DEUTSCH	MIL-C-26482 SERIES 1 & 2
RBC	18	DEUTSCH	MIL-C-83723 SERIES I
RR	21	HELLERMANN DEUTSCH	PATTERN 602
S*A-2000	6	HERMETIC SEAL CORP.	MIL-C-5015
S*A-2000	19	HERMETIC SEAL CORP.	MIL-C-83723 SERIES II.
S*A-7000	9	HERMETIC SEAL CORP.	MIL-C-26482 SERIES 1 & 2 .
S*A-7000	18	HERMETIC SEAL CORP.	MIL-C-83723 SERIES I
SA	6	IPI (SAE)	MIL-C-5015
SA	19	IPI (SAE)	MIL-C-83723 SERIES II
SCP	6	BENDIX	MIL-C-5015
SCP	19	BENDIX	MIL-C-83723 SERIES II
SERIES I	12	ELECTRONIC SEALS	MIL-C-38999 SERIES I
SERIES II	13	ELECTRONIC SEALS	MIL-C-38999 SERIES II
SERIES III	14	ELECTRONIC SEALS	MIL-C-38999 SERIES III
SERIES IV	15	ELECTRONIC SEALS	MIL-C-38999 SERIES IV
SJT	22	BENDIX	SJT
SP	9	BENDIX	MIL-C-26482 SERIES 1 & 2

PREFIX	PAGE	MANUFACTURER	CONNECTOR SERIES (REFERENCE)
SP	18	BENDIX	MIL-C-83723 SERIES I
SP*CE	9	BENDIX	MIL-C-26482 SERIES 1 & 2
SP*CE	18	BENDIX	MIL-C-83723 SERIES I
T3	14	PYLE-NATIONAL	MIL-C-38999 SERIES III
TBF	6	BENDIX	MIL-C-5015
TBF	6	ITT CANNON	MIL-C-5015
TBF	19	BENDIX	MIL-C-83723 SERIES II
TBF	19	ITT CANNON	MIL-C-83723 SERIES II
TBFH	6	ITT CANNON	MIL-C-5015
TBFH	19	ITT CANNON	MIL-C-83723 SERIES II
TCT	14	PLESSEY	MIL-C-38999 SERIES III
TV	14	BENDIX	MIL-C-38999 SERIES III
VE	6	VEAM/LITTON	MIL-C-5015
VE	19	VEAM/LITTON	MIL-C-5015
VG	6	VEAM/LITTON	MIL-C-5015
VPT	9	VEAM/LITTON	MIL-C-26482 SERIES 1 & 2
VPT	18	VEAM/LITTON	MIL-C-83723 SERIES I
VPT*SE	9	VEAM/LITTON	MIL-C-26482 SERIES 1 & 2
VPT*SE	18	VEAM/LITTON	MIL-C-83723 SERIES I
VS	6	VEAM/LITTON	MIL-C-5015
VS	19	VEAM/LITTON	MIL-C-83723 SERIES II
VTBF	6	VEAM/LITTON	MIL-C-5015
VTBF	19	VEAM/LITTON	MIL-C-83723 SERIES II
VUT	9	VEAM/LITTON	MIL-C-26482 SERIES 1 & 2
VUT	18	VEAM/LITTON	MIL-C-83723 SERIES I
WFS	6	ITT CANNON	MIL-C-5015
WFS	19	ITT CANNON	MIL-C-83723 SERIES II
ZZ	10	PYLE-NATIONAL	MIL-C-26500

TYPICAL METHODS FOR ALTERNATE KEYING

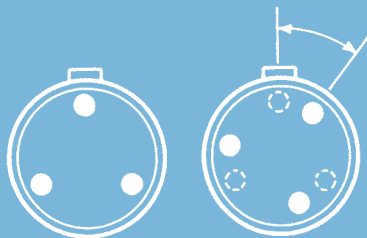

INSERT ROTATION
(KEYS REMAIN STATIONARY)

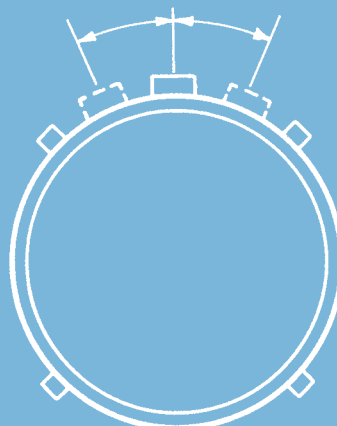

MASTER KEY ROTATION

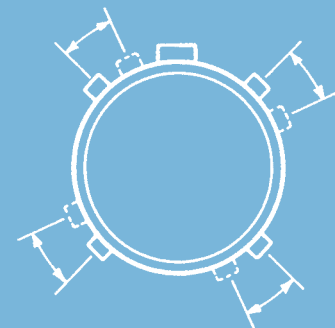

MINOR KEY ROTATION

CONNECTOR MATE[®] ASSEMBLY VISE

**CONNECTOR
MATE[®]**



The continuing demands of electrical system designers have imposed such rapid development in the field of interconnection technology that new and different hardware is emerging to meet those demands. Along with the introduction of these new, and often more complex connectors and accessories, the challenge for versatile and reliable production tooling becomes apparent. To this end, DMC has accepted the challenge by developing the assembly station vise which provides a reliable and repeatable holding method for countless combinations of connectors and accessories. The use of removable soft-grip jaw inserts allows the vise to easily accommodate all popular connector diameters.

This is a reliable method of retaining circular parts, which avoids damage to critical platings and retains the circular shape of delicate parts.

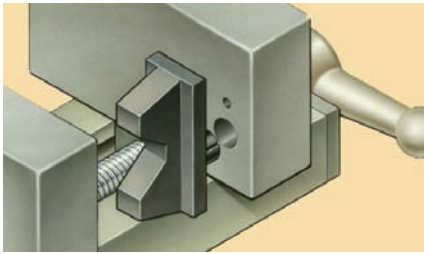

ADJUSTABLE STOP: An added feature for convenience and efficiency of operation is the adjustable stop on the vise. This provides for extra gripping stability and a repeatable reference for production line applications.

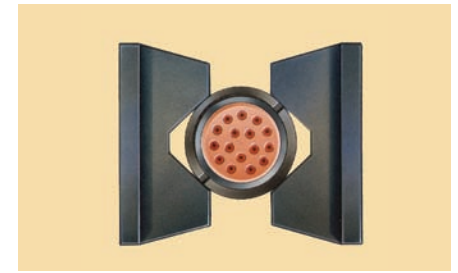

If the force is applied on opposite sides (only two pressure points), the circular part will tend to collapse, and this will produce false torque readings because of increased friction between the components where the threads have been forced together.

A square drive on the thread handle allows the use of a torque device to minimize the possibility of overtightening.

The position of the jaw inserts in the vise can be changed to hold the work in the most convenient location for assembly.

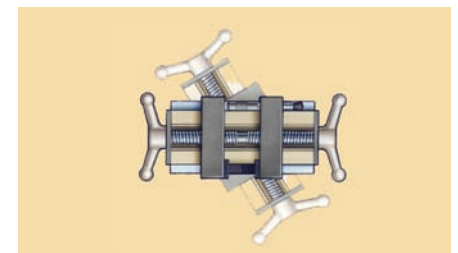

The jaw inserts come packaged in a convenient metal container which keeps them clean, orderly and readily available for use. Instructions are also provided for their proper use. There are twelve pairs of jaw inserts in the container which accommodate diameters from 3/8" to 3".

ASSEMBLY VISE	
BT-VS-511	ASSEMBLY VISE WITH 24-PIECE SET OF JAW INSERTS
BT-VS-500	ASSEMBLY VISE ONLY (WITHOUT JAW INSERTS)
BT-S-550	24-PIECE SET OF JAW INSERTS, FOR USE WITH VISE BT-VS-500

HOW THE ASSEMBLY VISE WORKS

The system consists of non-marring jaw inserts and a specially designed vise to hold them. They can be used to hold any circular part within the size range available, including connectors, backshell accessories and adaptor tools.

In a conventional vise, one jaw is stationary, while the other moves on the thread mechanism. The assembly station vise is different in that it employs an *opposing thread design* — that is, both jaws move in synchronization. This design has several advantages for connector assembly:

FAST TIGHTENING: A part can be secured faster, which is a benefit to production procedures.

HIGH STRENGTH: A substantial increase in strength and thread life is achieved by the double-thread arrangement.

SELF-CENTERING: Because the jaws move towards each other, the work is always centered in the vise, and therefore, lateral stress and unnecessary movement of the work pieces are not introduced into the process.

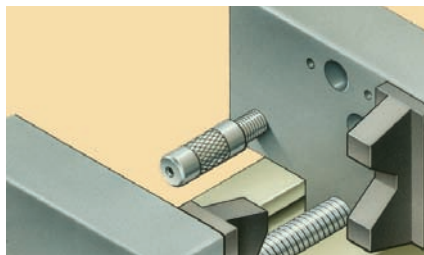

JAW SETS

A set of jaws is designed to accommodate diameters from .375" to 3.00" (3/8" to 3"), within six different jaw sizes. This provides for flexibility of application — the same system can be used for most or all of the circular connectors and accessories in a cable assembly operation.

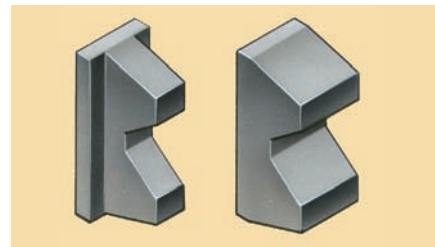

Jaws are available in two gripping widths — .400" and 1.000". The narrow jaws allow access to accessories which are smaller in diameter than adjacent components, whereas the wider jaws allow for a large grip area when higher torque values are required.

Jaws are made from high-friction material which will not damage connectors or accessories, yet will provide sufficient grip for most operations.

Prevents deformation of circular connectors and accessories by applying holding pressure evenly at four points on the circumference. That is, the jaws apply a force radially at four points equally spaced around the circumference such that the circular part readily accepts it without deformation.

DIGITAL TORQUE TOOL



TORQUE RANGE:

IN-LB = 15 ~ 300 IN-LB
 FT-LB = 1.25 ~ 25 FT-LB
 KG-CM = 1.7 ~ 345 KG-CM
 N M = 1.7 ~ 33N.M

Higher Torque ratings to meet mechanical fastening requirements and the need for improved electrical bonding have fostered the need for an improved Torque Tightening System. DMC has responded to that need with a unique Digital Torque System that is rugged, flexible, and easy to use. This highly repeatable Digital Torque System can be easily used with other BETA™ Connector Accessory Tools to maintain precise tightening consistency through every facet of wiring system final assembly.

Normally, torque is only thought of as a means to prevent an assembly from loosening under vibration or other external forces. But in the present environment it is equally important not to over tighten an assembly risking damage to plating, threads, or fastening components made of metal or composite materials, and risking

failure, or a reduced service life of the wiring system.

DMC introduces the BT-ST-300D Digital Torque Tool which provides OEMs and field service techs with a simple and efficient way to precisely measure the torque values. This state-of-the-art product was developed specifically to meet the demands of connector and connector/accessory final assembly. The optional Static Mount Base was an integral design objective to provide OEM and Depot level operations utilization of the Digital Torque Tool as a bench-top or wiring board mountable Torque Station.

Several features of the tool make it a great addition to the DMC BETA™ Connector Accessory Tool product line. A few of the many features are listed to the right:

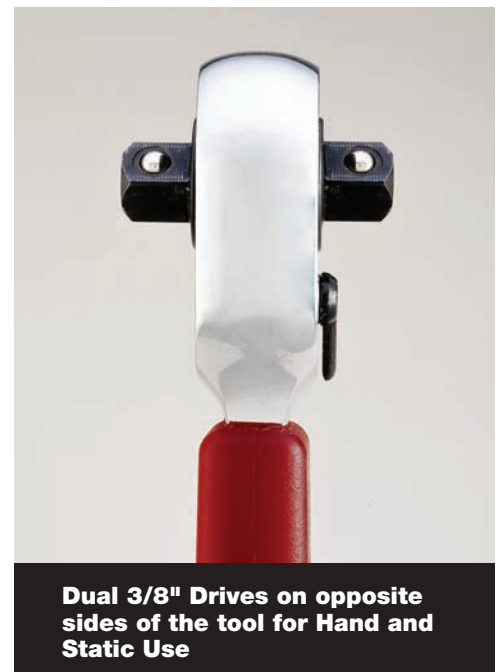

Dual 3/8" Drives on opposite sides of the tool for Hand and Static Use

- Visual and audible warning when the force torque reaches 90%, 100%, and 110% of the set torque.
- Saves last 99 torque values.
- Clear, sliding cover helps prevent accidental touching of keys.
- 1/4" drive adapter included
- Standard AAA batteries (2 batteries are included).

HAND-HELD DIGITAL TORQUE TOOLS	
BT-ST-300D	DIGITAL TORQUE TOOL, 15-300 INCH POUNDS
BT-D-0551	ADAPTER – 3/8" DRIVE TO 1/4" SOCKET (Included)

TORQUE ACCURACY				
IN-LB	FT-LB	KG-CM	N.M	ACCURACY
30-300	2.5-25	34.5-345	3.4-33	CW +/-2% / CCW +/-3%
15-29	1.25-2.4	17.3-33.4	1.7-3.3	CW +/-4% / CCW +/-6%

DMC torque wrench calibration data is traceable to NIST.

STATIC MOUNT BASES FOR DIGITAL TORQUE TOOLS

DMC's Static Mount Base is a secure system to mount the Digital Torque Tool in a static position. Until now, it required two separate torque devices to have the ability for portable or static (or stationary) use, but DMC has designed one system that allows the conversion of a hand-held portable unit into a stable, high production torque station in just a few minutes. This will allow a hands-free environment that is accurate, repeatable, and a far more ergonomic torque station for final assembly.

The base can be configured for horizontal or vertical positioning

of the tool and allows the tool to tilt 90 degrees in each configuration for usability. The tool can still be switched between clockwise and counter-clockwise functions while attached to the Static Mount Base. Because of their compact size and lightweight construction, it can be mounted in a variety of locations either on workbench or even on harness form board.

There will sometimes be applications where the use of a static unit is impractical. In which case, the Digital Torque Tool is easily removed from the Static Mount Base.

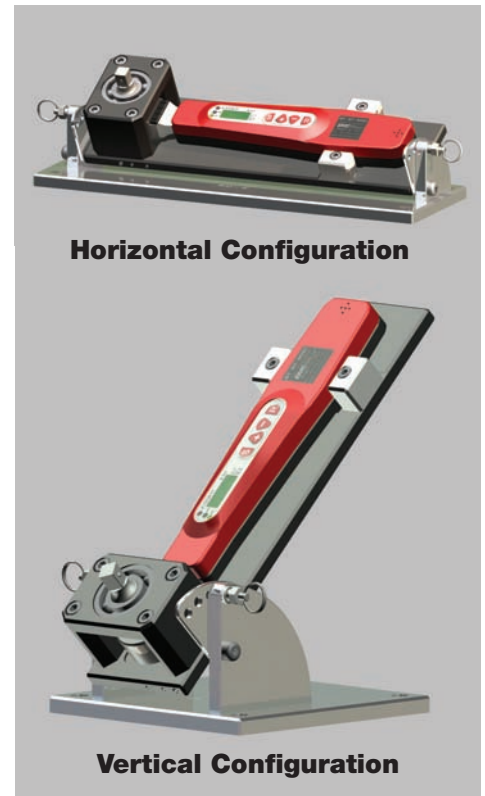

Horizontal Configuration

Vertical Configuration

STATIC MOUNT DIGITAL TORQUE TOOL	
BT-ST-300D	DIGITAL TORQUE TOOL, 15-300 INCH POUNDS
BM-6	STATIC MOUNT BASE FOR BT-ST-300D



The BT-BS-611T is shown here.

STRAP WRENCH ATTACHMENT FOR THE DIGITAL TORQUE TOOL

DMC's handle-less strap wrench line has been specifically designed for torque accurate connector assembly. Based on DMC's established line of torque wrenches, the handle-less strap wrench attaches to the BT-ST-300D and provides accurate torque without the interference of the strap wrench handle.

Modern connectors and accessories comprised of lightweight materials, torque sensitive threads, and critical platings have mandated the requirement for precision strap wrenches. DMC Strap Wrenches meet this need by applying a uniform grip around the diameter and avoid pressure points or metal-to-metal contact.

A variety of widths and lengths of straps is available in several different head configurations, so the system is suited to all common connector applications. See page 35 or our Web site for a full list of handle-less strap wrench part numbers.



PART NUMBER	STRAP WIDTH	GRIPPING DIAMETER
BT-BS-609T	1/2"	.50" to 2.50"
BT-BS-610T	1/2"	.25" to 1.50"
BT-BS-611T	5/8"	1.00" to 4.00"
BT-BS-618T	1"	1.00" to 4.00"

Different colored straps and strap configurations have different part numbers. See page 35.

STRAP WRENCHES

DMC strap wrenches have been specifically designed for connector assembly, rather than merely adapted from another use. The combination of lightweight materials, torque sensitive threads, and critical platings on modern connectors has mandated the requirement for precision made strap-wrenches, which apply a uniform grip around the diameter and avoid pressure points or metal-to-metal contact.

A variety of widths and lengths of straps is available, in several different handle configurations, so the system is suited to all common connector applications.



STANDARD STRAP WRENCHES

TOOL TIP STYLE	WRENCH P/N	STRAP P/N	STRAP WIDTH (COLOR)	STRAP LOOPED	SUGGESTED GRIPPING DIAMETER															
A	BT-BS-610	BT-A-6010	1/2" (Black)	Yes	.25" to 1.50"															
	BT-BS-610B*	BT-A-6010B*	1/2" (Blue)	Yes	.25" to 1.50"															
	BT-BS-610W	BT-A-6010W	1/2" (White)	Yes	.25" to 1.50"															
	BT-BS-610R	BT-A-6010R	1/2" (Red)	Yes	.25" to 1.50"															
B	BT-BS-609	BT-A-6010	1/2" (Black)	Yes	.50" to 2.50"															
	BT-BS-609B*	BT-A-6010B*	1/2" (Blue)	Yes	.50" to 2.50"															
	BT-BS-609W	BT-A-6010W	1/2" (White)	Yes	.50" to 2.50"															
	BT-BS-609R	BT-A-6010R	1/2" (Red)	Yes	.50" to 2.50"															
C	BT-BS-611	BT-A-6175	5/8" (Black)	Yes	1.00" to 4.00"															
	BT-BS-611B*	BT-A-6175B*	5/8" (Blue)	Yes	1.00" to 4.00"															
	BT-BS-611W	BT-A-6175W	5/8" (White)	Yes	1.00" to 4.00"															
C	BT-BS-618	BT-A-6185	1" (Black)	Yes	1.00" to 4.00"															
	BT-BS-618B*	BT-A-6185B*	1" (Blue)	Yes	1.00" to 4.00"															
	BT-BS-618W	BT-A-6185W	1" (White)	Yes </tr <tr> <td rowspan="2">D</td> <td>BT-BS-625</td> <td>BT-A-6250</td> <td>1/2" (Red)</td> <td>Yes</td> <td>.50" to 2.0"</td> </tr> <tr> <td>BT-BS-630</td> <td>BT-A-6300</td> <td>7/16" (Black)</td> <td>Yes</td> <td>.50" to 2.0"</td> </tr> <tr> <td>E</td> <td colspan="5">The Handle-Less Strap Wrenches are presented on page 35.</td> </tr>	D	BT-BS-625	BT-A-6250	1/2" (Red)	Yes	.50" to 2.0"	BT-BS-630	BT-A-6300	7/16" (Black)	Yes	.50" to 2.0"	E	The Handle-Less Strap Wrenches are presented on page 35.			
D	BT-BS-625	BT-A-6250	1/2" (Red)	Yes		.50" to 2.0"														
	BT-BS-630	BT-A-6300	7/16" (Black)	Yes	.50" to 2.0"															
E	The Handle-Less Strap Wrenches are presented on page 35.																			

*The blue series strap wrench and replacement straps are preferred for connector/accessory use.

SEE TORQUE CONVERSION CHARTS ON PAGE 37 FOR USE OF STRAP WRENCHES IN COMBINATION WITH TORQUE TOOLS.



STRAPS

The straps for DMC Strap Wrenches are available in four styles (which are color coded for easy identification) to better meet the needs of individual applications.



The **Black Strap** is the traditional rubber strap for DMC strap wrenches. It is the most flexible and grip-friendly of all strap materials, but requires replacement more often than other strap constructions. It is good for all sizes, and flexible enough to grip smaller diameters (.25 to .75 inches). But the black strap is not recommended for high torque range tightening. It is available in looped and loopless configurations. Because of the shorter service life of this material, we recommend the loopless version so the user can make adjustments to compensate for wear or breakage.

The **Blue Strap** is made of a thin layer of extruded polyethylene over a nylon belt. This strap is the preferred choice for all general purpose connector and backshell tightening applications, and it has good service life at medium to high-medium torque ranges. The Blue Straps, although not as flexible and grip-friendly as the Black Rubber straps, are a good choice because of the increased durability. This strap will grip .75 inch diameters and larger, and is available in looped and loopless configurations.

The **Red Strap** is the same material and construction as the Blue Strap, but it is thicker and stronger for higher torque range tightening and increased durability. This heavy duty construction allows it to be used on smooth or knurled surfaces, and can be used to tighten fittings with 1.0 inch diameters and larger. It is available in looped and loopless versions.

The **White Strap** is a traditional hard rubber construction option that has a durable rubber surface on one side. It is used effectively where high strength is needed, but flexibility is not important. It is well suited to all diameters of 2.0 inches or larger. Due to its sturdy & thick construction, the white strap is only available in looped configuration.

NOTE: Strap length and width are important considerations in selecting a strap wrench and the replacement straps. Sometimes Grip Pads are recommended for use with strap wrenches to add traction while tightening some surfaces. If you have any questions about the best combination for your application, contact DMC.

STRAP WRENCH SIZES



A: The BT-BS-610 Series tool tip is our small-diameter tip and designed to accommodate connectors and backshells with diameters from .25 to 1.5 inches. Straps are .5 an inch wide.

B: The BT-BS-609 Series tool tip is our most popular choice for general purpose use. The mid-diameter tip is designed to accommodate connectors and backshells with diameters from .5 to 2.50 inches. Straps are .5 an inch wide.

C: The BT-BS-611 Series tool tip is our large-diameter tip designed to accommodate connectors and backshells with diameters from 1 to 4 inches. Straps are 5/8 an inch wide.

C: The BT-BS-618 Series tool tip is also a large-diameter tip like the BT-BS-611 designed to accommodate connectors and backshells with diameters from 1 to 4 inches, but with a 1 inch wide strap for better gripping and applying higher torque values.

STRAP COLORS

COLOR	SMALL DIAMETERS	MEDIUM DIAMETERS	LARGE DIAMETERS	TORQUE RANGE	LOOPLESS AVAILABLE
Black	X	X	X	Med	X
Blue*	X	X	X	Med-High	X
Red		X	X	High	X
White		X	X	High	

STRAP CONFIGURATIONS

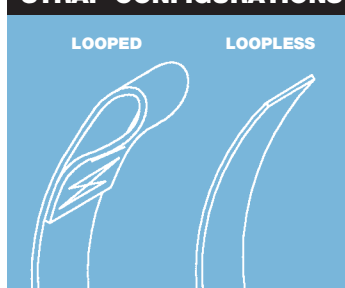

*The blue straps are preferred for connector/ accessory use.

LOOPLESS-STRAP STRAP WRENCH

All straps wear and break. The most common point of wear is at the upper edge of the tool tip, near the base of the strap. The standard straps have a loop sewn into one end and attach to the wrench body with a simple link. However, when the strap eventually breaks, it is unusable.

The Loopless Strap Tool Series uses a clamping buckle to attach a loopless strap to the wrench body. When a loopless strap breaks at the strain point, the majority of the strap is still usable. The operator simply removes the broken section, installs the remaining strap, and continues working.

LOOPLESS STRAP INSTALLATION

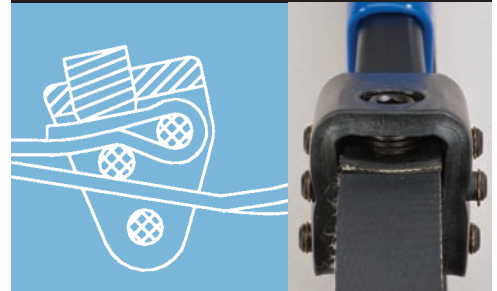

The strap is inserted into the buckle, fed back over itself, and clamped in place with a 7/32 inch set screw.

LOOPLESS-STRAP STRAP WRENCHES					
TOOL TIP STYLE	WRENCH P/N	STRAP P/N	STRAP WIDTH (COLOR)	STRAP LOOPED	SUGGESTED GRIPPING DIAMETER
A	BT-BS-610SS	BT-A-6010-BK	1/2" (Black)	No	.25" to 1.50"
	BT-BS-610BSS	BT-A-6010B-BK*	1/2" (Blue)	No	.25" to 1.50"
	BT-BS-610RSS	BT-A-6010R-BK	1/2" (Red)	No	.25" to 1.50"
B	BT-BS-609SS	BT-A-6010-BK	1/2" (Black)	No	.50" to 2.50"
	BT-BS-609BSS	BT-A-6010B-BK*	1/2" (Blue)	No	.50" to 2.50"
	BT-BS-609RSS	BT-A-6010R-BK	1/2" (Red)	No	.50" to 2.50"
C	BT-BS-611SS	BT-A-6175-BK	5/8" (Black)	No	1.00" to 4.00"
	BT-BS-611BSS*	BT-A-6175B-BK*	5/8" (Blue)	No	1.00" to 4.00"
C	BT-BS-618SS	BT-A-6185-BK	1" (Black)	No	1.00" to 4.00"
	BT-BS-618BSS*	BT-A-6185B-BK*	1" (Blue)	No	1.00" to 4.00"

*The blue series strap wrench and replacement straps are preferred for connector/accessory use.



Loopless-Strap Wrench **Loopless Strap**



Looped Strap Wrench **Looped Strap**

See Torque Conversion Charts on page 37 for use of strap wrenches in combination with torque tools.

STANDARD DMC STRAP WRENCHES CAN BE CONVERTED TO "LOOPLESS".

All strap wrenches can be ordered as Loopless versions. However, if you already own DMC strap tools, we offer a Retro Fit Kit to convert your existing looped strap tools to Loopless Strap Tools

RETROFIT KITS to convert looped strap tools to loopless strap tools.

Retrofit Kit P/N	for Tool P/N	Strap Width (color)	Strap Looped	Suggested Gripping Diameter
BT-BS-609SS-RK	BT-BS-609	1/2" (Black)	No	.50" to 2.50"
BT-BS-609BSS-RK	BT-BS-609B	1/2" (Blue)	No	.50" to 2.50"
BT-BS-610SS-RK	BT-BS-610	1/2" (Black)	No	.25" to 1.50"
BT-BS-610BSS-RK	BT-BS-610B	1/2" (Blue)	No	.25" to 1.50"
BT-BS-611SS-RK	BT-BS-611	5/8" (Black)	No	1.00" to 4.00"
BT-BS-618SS-RK	BT-BS-618	1" (Black)	No	1.00" to 4.00"

RETROFIT KIT COMPONENTS





The **BT-BS-611T** is shown here.

HANDLE-LESS STRAP WRENCHES

DMC's handle-less strap wrench line has been specifically designed for torque-accurate connector assembly. Based on DMC's established line of torque wrenches, the handle-less strap wrench attaches to the **BT-ST-300D Digital Torque Tool** and provides accurate torque without the interference of the strap wrench handle.

SEE PAGE 37 FOR TORQUE CONVERSION TABLES.

HANDLE-LESS STRAP WRENCHES FOR TORQUE WRENCHES					
TOOL TIP STYLE	WRENCH P/N	STRAP P/N	STRAP WIDTH (COLOR)	STRAP LOOPED	SUGGESTED GRIPPING DIAMETER
HANDLE-LESS LOOPED STRAP WRENCHES					
A	BT-BS-610T	BT-A-6010	1/2" (Black)	Yes	.25" to 1.50"
	BT-BS-610BT*	BT-A-6010B*	1/2" (Blue)	Yes	.25" to 1.50"
	BT-BS-610WT	BT-A-6010W	1/2" (White)	Yes	.25" to 1.50"
	BT-BS-610RT	BT-A-6010R	1/2" (Red)	Yes	.25" to 1.50"
B	BT-BS-609T	BT-A-6010	1/2" (Black)	Yes	.50" to 2.50"
	BT-BS-609BT*	BT-A-6010B*	1/2" (Blue)	Yes	.50" to 2.50"
	BT-BS-609WT	BT-A-6010W	1/2" (White)	Yes	.50" to 2.50"
	BT-BS-609RT	BT-A-6010R	1/2" (Red)	Yes	.50" to 2.50"
C	BT-BS-611T	BT-A-6175	5/8" (Black)	Yes	1.00" to 4.00"
	BT-BS-611BT*	BT-A-6175B*	5/8" (Blue)	Yes	1.00" to 4.00"
	BT-BS-611WT	BT-A-6175W	5/8" (White)	Yes	1.00" to 4.00"
C	BT-BS-618T	BT-A-6185	1" (Black)	Yes	1.00" to 4.00"
	BT-BS-618BT*	BT-A-6185B*	1" (Blue)	Yes	1.00" to 4.00"
	BT-BS-618WT	BT-A-6185W	1" (White)	Yes	1.00" to 4.00"
HANDLE-LESS LOOPLESS STRAP WRENCHES					
A	BT-BS-610SST	BT-A-6010-BK	1/2" (Black)	No	.25" to 1.50"
	BT-BS-610BSST	BT-A-6010B-BK*	1/2" (Blue)	No	.25" to 1.50"
	BT-BS-610RSST	BT-A-6010R-BK	1/2" (Red)	No	.25" to 1.50"
B	BT-BS-609SST	BT-A-6010-BK	1/2" (Black)	No	.50" to 2.50"
	BT-BS-609BSST	BT-A-6010B-BK*	1/2" (Blue)	No	.50" to 2.50"
	BT-BS-609RSST	BT-A-6010R-BK	1/2" (Red)	No	.50" to 2.50"
C	BT-BS-611SST	BT-A-6175-BK	5/8" (Black)	No	1.00" to 4.00"
	BT-BS-611BSST*	BT-A-6175B-BK*	5/8" (Blue)	No	1.00" to 4.00"
C	BT-BS-618SST	BT-A-6185-BK	1" (Black)	No	1.00" to 4.00"
	BT-BS-618BSST*	BT-A-6185B-BK*	1" (Blue)	No	1.00" to 4.00"

*The blue series strap wrench and replacement straps are preferred for connector/accessory use.

TORQUE CONVERSION FORMULA

Torque is a standard term that is comprised of “distance and force”. Since the force is applied to a threaded component in a circular motion, the distance applies to the radius (center of the torque wrench drive to a designated point on the torque wrench handle). In the case of wire harness applications, it is usually expressed in INCH-POUNDS, NEWTON-METERS, or KILOGRAM-CENTIMETERS. When extensions such as a crowfoot, or strap wrench is added to a torque wrench, it changes the distance (radius), so a mathematical formula is used to determine the correct torque readings on the torque wrench to compensate for the added length. We have included the following formulas for your convenience.

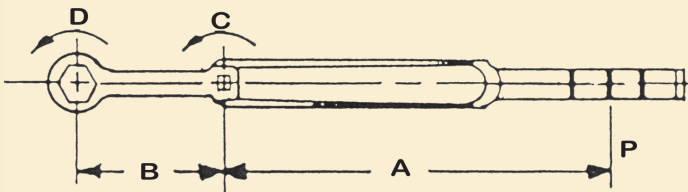

When an adapter or extension is used on a torque wrench it increases the torque range of the wrench. The formulae for computing torque when using an adapter or extension is explained below.

- A** = (Length) Distance from center of torque wrench square drive to center of the puller's hand grip.
- B** = Distance from center of torque wrench square drive to center of drive at end of extension.
- C** = (Torque) Torque wrench setting.
- D** = Torque desired at drive on end of extension.
- P** = (Force) Pull applied.

To determine torque wrench setting:

$$C = (D \cdot A) / (A + B)$$

NOTE: After computing “C” and setting wrench to computation, measure and mark “A” where pull is applied.

It is recommended that the axis of the extension always be used in line with axis of the torque wrench as shown above.

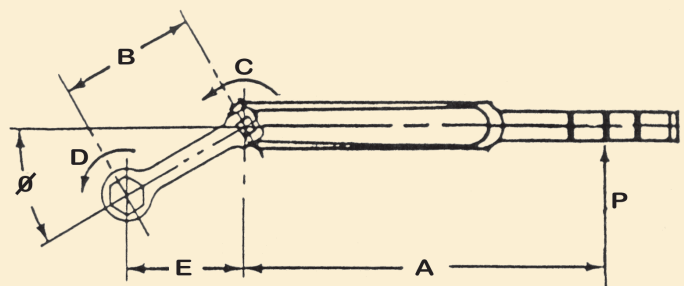

Should it be necessary, due to obstructions, to have an angle between the two axes, then the above formula is modified as follows. Due to increasing rounding errors, keep the angle as small as possible.

- A, B, C, D, & P** are the same as above.
- E** = Effective moment arm of the extension.
- Ø** = Angle between extension axis and torque wrench axis.

$$E = (B)(\cos \theta)$$

Therefore:

$$C = (D \cdot A) / (A + (B \cdot \cos \theta))$$

When $\theta = 0$, $\cos \theta = 1$, then equation is reduced to $C = (D \cdot A) / (A + B)$

When $\theta = 90^\circ$, $\cos \theta = 0$ then $C = D$
(Regardless of the length B)

TORQUE CONVERSION CHARTS

These torque conversion charts were calculated for the **BT-ST-300D Digital Torque Tool**. If any other torque tool or instrument is used, calculate the torque conversion by using the mathematical formula to page 36.

TORQUE CONVERSION CHART FOR BT-BS-609 SERIES USED WITH BT-ST-300D									
Diameter of Part Being Tightened	DESIRED TORQUE VALUE (in-lbs) ("D")								
	40	60	80	100	120	140	160	180	200
0.50"	34	50	67	84	101	118	135	151	168
0.75"	33	50	66	83	99	116	133	149	166
1.00"	33	49	65	82	98	114	131	147	163
1.50"	32	48	64	79	95	111	127	143	159
1.75"	31	47	63	78	94	110	125	141	157
2.00"	31	46	62	77	93	108	124	139	155
2.25"	31	46	61	76	92	107	122	137	153
2.50"	30	45	60	75	90	105	121	136	151
TORQUE READING ON INSTRUMENT ("C")									

TORQUE CONVERSION CHART FOR BT-BS-611 AND BT-BS-618 SERIES USED WITH BT-ST-300D									
Diameter of Part Being Tightened	DESIRED TORQUE VALUE (in-lbs) ("D")								
	40	60	80	100	120	140	160	180	200
1.00"	31	46	61	76	92	107	122	137	153
1.50"	30	45	59	74	89	104	119	134	148
1.75"	29	44	59	73	88	103	117	132	147
2.00"	29	43	58	72	87	101	116	130	145
2.25"	29	43	57	71	86	100	114	129	143
2.50"	28	42	56	70	85	99	113	127	141
2.75"	28	42	56	70	84	97	111	125	139
3.00"	28	41	55	69	83	96	110	124	138
3.25"	27	41	54	68	82	95	109	122	136
3.50"	27	40	54	67	81	94	107	121	134
3.75"	27	40	53	66	80	93	106	119	133
4.00"	26	39	52	66	79	92	105	118	131
TORQUE READING ON INSTRUMENT ("C")									

TORQUE CONVERSION CHART FOR BT-BS-610 SERIES USED WITH BT-ST-300D									
Diameter of Part Being Tightened	DESIRED TORQUE VALUE (in-lbs) ("D")								
	40	60	80	100	120	140	160	180	200
0.25"	36	54	72	89	107	125	143	161	179
0.50"	35	52	70	87	104	122	139	156	174
0.75"	34	51	68	86	103	120	137	154	171
1.00"	34	51	67	84	101	118	135	152	169
1.50"	33	49	65	81	98	114	130	146	163
TORQUE READING ON INSTRUMENT ("C")									

GENERAL PURPOSE BACKSHELL/ACCESSORY TOOLS

TOOL IDENTIFICATION CHART (SEE PHOTO)		
A.	BT-HT-110	1/4" Socket Drive Handle
B.	BT-HT-210	1/4" Stationary Drive Mounting Arm
	BT-HT-211	3/8" Stationary Drive Mounting Arm
C.	BT-D-0551	3/8" to 1/4" Adapter
	BT-D-0622	1/4" to 3/8" Adapter
D.	BT-HT-107	3/8" Square Drive T-Handle Wrench
E.	BT-HT-100	1/4" Square Drive T-Handle Wrench
F.	BT-A-0513	Ratchet 3/8" Drive
G.	4-1149	Illuminated Magnifier



Consult the factory or authorized DMC distributor for more information.

JAM NUT SOCKETS



The correct application of torque is essential to most connector applications where Jam Nut receptacle connectors are used. The sealing components (usually an "O" ring) must be compressed, but not to the point of damage. Another important consideration when tightening Jam Nuts is the thread strength, especially in the various types of aluminum and composite connectors.

DMC's Jam Nut Socket tools have been developed specifically for the installation of Jam Nut receptacle connectors. They are available in a light weight composite construction, anodized machined aluminum, and durable steel series.

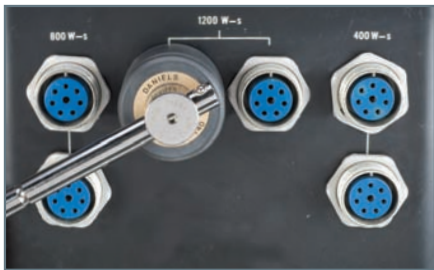

Jam Nut Sockets are ideal for torquing jam nuts on panels where several connectors are crowded together and in other tight spaces.

COMPOSITE JAM NUT SOCKETS

A unique process was developed to mold this composite material which contains a higher percentage of fiberglass than is customarily used in conventional molding technology. This makes them as light and as strong as possible. The material will not scratch plating, or damage the finish on cabinets, panels, or bulkheads when used properly.

ALUMINUM JAM NUT SOCKETS

When a metal socket is required, the anodized aluminum series jam nut sockets are a good choice. They are machined to the same configuration as the composite jam nut sockets with the square hold drive for torquing.

STEEL JAM NUT SOCKETS

A steel series of jam nut sockets is also available, which some users prefer for firewall or other applications where higher torque values are required.

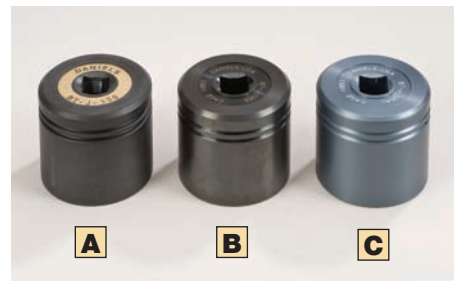

A COMPOSITE

B STEEL

C ALUMINUM

The traditional "General Purpose" formed stainless steel sockets (on page 40) are great for non-torque specific Jam Nut applications.



COMPOSITE OR METAL JAM NUT SOCKETS				
DMC PART NUMBER	FITS JAM NUT SIZE: INCHES	FITS JAM NUT SIZE: MILLIMETERS	SQUARE DRIVE	OUTSIDE DIAMETER REFERENCE
BT-J-117	.608 to .628	15.41 to 15.95	1/4	.914
BT-J-118*	.628 to .649	15.95 to 16.48	1/4	.955
BT-J-120	.671 to .693	17.04 to 17.60	1/4	.010
BT-J-121	.693 to .717	17.60 to 18.21	1/4	1.04
BT-J-122*	.717 to .741	18.21 to 18.82	1/4	1.07
BT-J-123	.741 to .765	18.82 to 19.43	1/4	1.10
BT-J-124	.765 to .791	19.43 to 20.09	1/4	1.13
BT-J-125	.791 to .818	20.09 to 20.77	1/4	1.16
BT-J-126	.818 to .845	20.77 to 21.46	1/4	1.19
BT-J-127	.845 to .873	21.46 to 22.17	1/4	1.22
BT-J-128	.873 to .902	22.17 to 22.91	1/4	1.26
BT-J-129	.902 to .933	22.91 to 23.69	1/4	1.29
BT-J-130	.933 to .964	23.69 to 24.48	3/8	1.33
BT-J-131	.964 to .996	24.48 to 25.29	3/8	1.36
BT-J-132	.996 to 1.030	25.29 to 26.16	3/8	1.41
BT-J-133	1.030 to 1.064	26.16 to 27.02	3/8	1.45
BT-J-134	1.064 to 1.100	27.02 to 27.94	3/8	1.51
BT-J-135	1.100 to 1.137	27.94 to 28.87	3/8	1.55
BT-J-136	1.137 to 1.175	28.87 to 29.84	3/8	1.59
BT-J-137	1.175 to 1.214	29.84 to 30.83	3/8	1.63
BT-J-138	1.214 to 1.255	30.83 to 31.87	3/8	1.69
BT-J-139	1.255 to 1.297	31.87 to 32.94	3/8	1.73
BT-J-140	1.297 to 1.340	32.94 to 34.03	3/8	1.78
BT-J-141	1.340 to 1.385	34.03 to 35.17	3/8	1.84
BT-J-142	1.385 to 1.432	35.17 to 36.37	3/8	1.89
BT-J-143	1.432 to 1.480	36.37 to 37.59	3/8	1.95
BT-J-144	1.480 to 1.529	37.59 to 38.83	3/8	2.00
BT-J-145	1.529 to 1.580	38.83 to 40.13	3/8	2.06
BT-J-146	1.580 to 1.633	40.13 to 41.47	3/8	2.12
BT-J-147	1.633 to 1.688	41.47 to 42.87	3/8	2.19
BT-J-148	1.688 to 1.745	42.87 to 44.32	3/8	2.25
BT-J-149	1.745 to 1.803	44.32 to 45.79	3/8	2.32
BT-J-150	1.803 to 1.864	45.79 to 47.34	3/8	2.39
BT-J-151	1.864 to 1.926	47.34 to 48.92	3/8	2.46
BT-J-152	1.926 to 1.991	48.92 to 50.57	3/8	2.54
BT-J-153	1.991 to 2.057	50.57 to 52.24	3/8	2.61
BT-J-154	2.057 to 2.126	52.24 to 54.00	3/8	2.69
BT-J-155	2.126 to 2.197	54.00 to 55.80	3/8	2.78
BT-J-156	2.197 to 2.271	55.80 to 57.68	3/8	2.87
BT-J-157	2.271 to 2.347	57.68 to 59.61	3/8	2.95
BT-J-158	2.347 to 2.426	59.61 to 61.62	3/8	3.04
BT-J-159	2.426 to 2.507	61.62 to 63.67	3/8	3.14
BT-J-160*	2.507 to 2.591	63.67 to 65.81	3/8	3.24
BT-J-161	2.591 to 2.678	65.81 to 68.02	3/8	3.34
BT-J-162	2.678 to 2.769	68.02 to 70.33	3/8	3.44
BT-J-163	2.769 to 2.860	70.33 to 72.64	3/8	3.54
BT-J-164	2.860 to 2.956	72.64 to 75.08	3/8	3.66
BT-J-165	2.956 to 3.055	75.08 to 77.59	3/8	3.77
BT-J-166	3.055 to 3.157	77.59 to 80.18	3/8	3.89
BT-J-170*	3.457 to 3.557	87.81 to 90.35	3/8	4.38

* Not available in composite material.

PART NUMBER **BT-J -XXX XX**

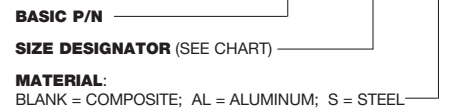

TO FIND THE CORRECT JAM NUT SOCKET FOR YOUR APPLICATION, MEASURE ACROSS THE FLATS OF THE JAM NUT YOU ARE WORKING WITH. NEXT, FIND THE SIZE RANGE IN THE ADJACENT TABLE. LISTED BESIDE IT WILL BE THE SOCKET YOU NEED.

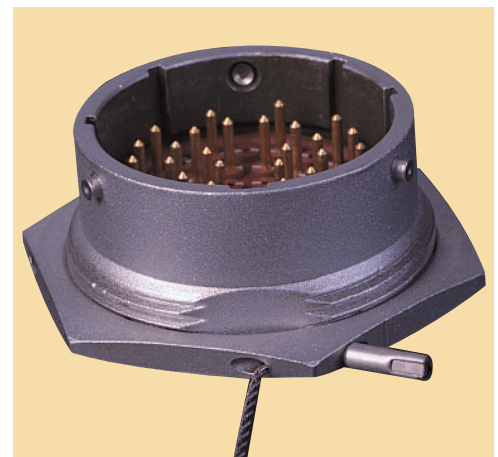

We also recommend that you consider DMC's **Safe-T-Cable**® to secure Jam Nut receptacles where lockwire holes are provided.

The Low Profile Ferrule (shown here) lends itself to an efficient security system for jam nut receptacles.

GENERAL PURPOSE JAM NUT SOCKETS

GENERAL PURPOSE JAM NUT SOCKETS

Formed Stainless Steel Jam Nut sockets are great for non-torque specific jam nut applications. They are plated for corrosion resistance, and have drive holes to accommodate a metal rod drive tool (P/N DW75).



ADJUSTABLE JAM NUT WRENCH

The **JR700** adjustable jam nut wrench is a versatile tool for maintenance and low volume production. The rugged all steel construction makes this tool a good choice for heavy duty applications.

The tool may be adjusted to accommodate hex nuts from .75 inch to 3.25 inch (across flat) dimensions. The maximum working depth is 1.0 inch. This range accommodates most common connectors.

A standard 3/8 inch drive torque tool may be used in conjunction with this tool to limit the possibility of overtightening. If torque values require close tolerance accuracy, direct reading sockets (page 38) are recommended.

GENERAL PURPOSE JAM NUT SOCKETS

DMC PART#	FITS JAM NUT SIZE: INCHES	AMPHENOL BCO PART NUMBER	HEX REF. DIM: INCHES	EQUIVALENT COMPOSITE
CS8	.755 to .763	11-6266-3	3/4"	BT-J-123
CS10	.880 to .888	11-6266-5	7/8"	BT-J-128
CS12	1.068 to 1.077	11-6266-8	1 1/16"	BT-J-134
CS14	1.194 to 1.204	11-6266-10	1 3/16"	BT-J-137
CS16	1.320 to 1.331	11-6266-12	1 5/16"	BT-J-140
CS18	1.446 to 1.457	11-6266-14	1 7/16"	BT-J-143
CS20	1.571 to 1.580	11-6266-16	1 9/16"	BT-J-145
CS22	1.696 to 1.708	11-6266-18	1 11/16"	BT-J-148
CS24	1.822 to 1.835	11-6266-20	1 13/16"	BT-J-150
CS22-1	2.011 to 2.025	11-6266-23	2"	BT-J-153
CS24-1	2.137 to 2.151	11-6266-25	2 1/8"	BT-J-155
CS32	2.640 to 2.687	11-6266-33	2 5/8"	BT-J-161 & BT-J-162
DMC1554	SET INCLUDES ALL 12 SOCKETS LISTED ABOVE AND DW75 DRIVE ROD.			

TORQUE CONVERSION CHART FOR JR700 TOOL USED WITH BT-ST-300D*

Diameter of Part Being Tightened	DESIRED TORQUE VALUE (in-lbs) ("D")								
	40	60	80	100	120	140	160	180	200
0.50"	22	33	45	56	67	78	89	100	111
0.75"	23	34	45	56	68	79	90	101	113
1.00"	23	34	45	57	68	80	91	102	114
1.50"	23	35	47	58	70	82	93	105	116
1.75"	24	35	47	59	71	83	94	106	118
2.00"	24	36	48	60	72	84	95	107	119
2.25"	24	36	48	60	73	85	97	109	121
2.50"	24	37	49	61	73	86	98	110	122
2.75"	25	37	50	62	74	87	99	111	124
3.00"	25	38	50	63	75	88	100	113	125
3.25"	25	38	51	63	76	89	101	114	127
TORQUE READING ON INSTRUMENT ("C")									

*FORMULA ON PAGE 36.

CIRCULAR RING PLIERS



Durable hinge allows tool to open 180°.

Pads are replaceable.



CIRCULAR RING PLIERS

The DRP-XX circular ring pliers are specifically designed to grip circular connector and backshell components which would be deformed by other gripping methods. The nonmarring rubber jaw lining material is available in strip form and may be used to replace worn jaw inserts. It is held in place by interlocking fingers which are molded into the material.

The following chart defines the working diameters and the tools which are available in this series.

Replacement Pads for Circular Ring Pliers are available (P/N DRP-078R). This replacement pad is supplied as a 4.25" strip that must be cut to length needed.

TOOL PART NUMBER	GRIP RANGE*	
	INCH	METRIC (mm)
DRP8	0.56 to 0.59	14.224 to 14.986
DRP9	0.62 to 0.65	15.748 to 16.51
DRP10	0.67 to 0.70	17.018 to 17.78
DRP11	0.74 to 0.77	18.796 to 19.558
DRP12	0.80 to 0.83	20.32 to 21.082
DRP13	0.85 to 0.88	21.59 to 22.352
DRP14	0.89 to 0.92	22.606 to 23.368
DRP16	1.05 to 1.08	26.67 to 27.432
DRP18	1.11 to 1.14	28.194 to 28.956
DRP20	1.27 to 1.30	32.258 to 33.02
DRP22	1.39 to 1.42	35.306 to 36.068
DRP24	1.49 to 1.52	37.846 to 38.608
DRP26	1.61 to 1.64	40.894 to 41.656
DRP28	1.89 to 1.92	48.006 to 48.768
DMC1924	Set of all 14 DRP SERIES PLIERS and 10 REPLACEMENT PADS	
DRP078R	REPLACEMENT PAD for all DRP SERIES PLIERS	

*ON A SMOOTH SURFACE.
KNURLED SURFACES SLIGHTLY BELOW THIS RANGE ARE COMPATIBLE WITH THESE TOOLS.



SOFT JAW ADJUSTABLE PLIERS

The BT-SJ-468 soft jaw adjustable pliers are a handy addition to general maintenance tool stations. This tool can provide a reliable gripping function for assembly, disassembly, and positioning of circular and oval parts.

The soft jaw inserts are replaceable and may be ordered as separate parts (part number BT-SJ-468-1). This part number applies to an individual jaw (two pieces are required per tool).

The overall length is 9.5 inches and the approximate weight is .5 lb.

EMI/RFI BAND APPLICATION SYSTEM FOR .125 & .250 SHIELD TERMINATION BANDS



The termination of EMI/RFI shielding materials is a specialized science in today's aerospace wiring systems. Application tooling is a critical factor in the overall performance of the wiring system components.

DMC has worked closely with the world's leading connector accessory manufacturers to develop the necessary tooling and accessories to meet the stringent demands of aerospace and defense system contractors. The resulting products afford the user many benefits which include:

COMPATIBILITY with all currently available termination bands and systems.

RELIABILITY through the use of commercially proven components and tool design practice.

QUALITY and REPEATABILITY which are assured by a patented tension system.

SERVICE AND CALIBRATION – All tools produced by DMC are adjustable, and may be easily recalibrated by the user. Also, expendable components such as cut-off blades are available for simple replacement by the user.

LONG SERVICE LIFE – Properly maintained band application tools will produce thousands of reliable terminations.

AFFORDABILITY – DMC tools continue to be the most cost effective method to produce reliable wiring system shield terminations.

THE PNEUMATIC BAND APPLICATION TOOL...

is a cost effective system that speeds production and improves ergonomic conditions which are present when manual tools are used. Band tension is precisely applied by a dependable pneumatic system which is consistent and repeatable.

The calibration system of the pneumatic band tool is adjustable, and can be checked by use of the calibration devices available from DMC.

The cutter blade and other components of the DMC Pneumatic Band tools are interchangeable with the DBS-1100 and DBS-1200 series hand tools. The rugged design and field replaceable blades make the PBT/PMBT series the best choice for production applications where EMI/RFI bands are used to terminate wire harness shielding.

THE HAND OPERATED BAND APPLICATION TOOL...

is an excellent choice for many production and maintenance operations. Like the power driven models, they too can be calibrated by the user to provide reliable terminations throughout the service life.

The lightweight construction and small "nose" profile enable the user to apply termination bands in even the tightest of working areas.

Models are available for .250 in. (6.350 mm) and .125 in. (3.175 mm) wide bands from all current suppliers.

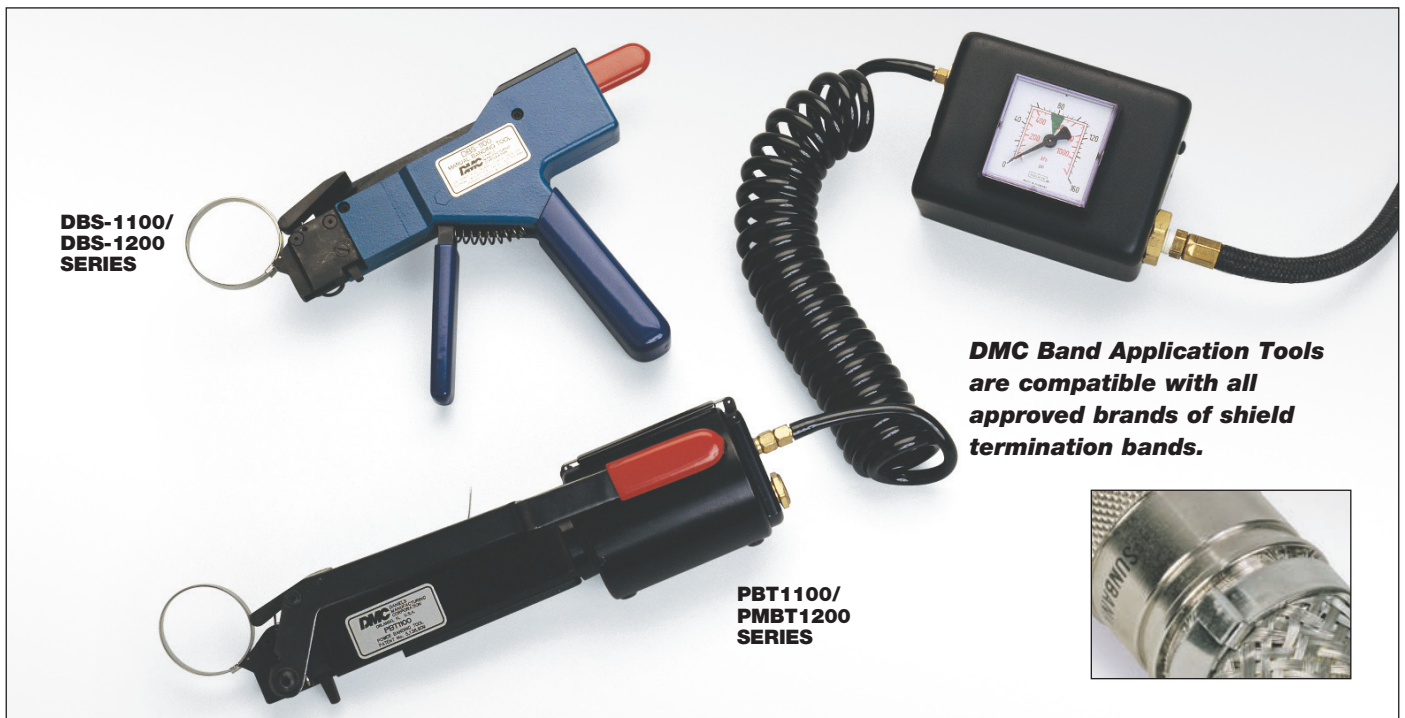

**DBS-1100/
DBS-1200
SERIES**

**PBT1100/
PMBT1200
SERIES**

**DMC Band Application Tools
are compatible with all
approved brands of shield
termination bands.**





DBS-1100 & DBS-1200 HAND OPERATED BAND APPLICATION TOOLS

The DBS series Hand Application Tools are constructed to survive the demands of production and maintenance use, and remain precisely adjusted to provide a quality band termination.

The patented tension-lock system gives the operator a positive indication when the precise tension has been applied.

DBS-1100

.250 Wide Band Application Tool

- Size and Weight: 5.5" x 7.5", .36 lbs.
- Calibration Range: 140–160 lbs.
- Cut-off blade: replaceable with DBS-1100-7

DBS-1200

.125 Wide Mini-Band Application Tool:

- Size and Weight: 5.5" x 7.5", .52 lbs.
- Calibration Range: 62–82 lbs.
- Cut-off blade: replaceable with DBS-1100-7



PBT1100 & PMBT1200 PNEUMATIC BAND APPLICATION TOOLS

The PBT & PMBT series Pneumatic Band Application Tools are lightweight, dependable, and easy to operate. Many of the components are interchangeable with the corresponding hand tool.

PBT1100

.250 Wide Band Application Tool

- Size and Weight: 8.75" L, 1.52 lbs.
- Calibration Range: 140–160 lbs.
- Hose Length: 10' Extended
- Cut-off blade: replaceable with DBS-1100-7

PMBT1200

.125 Wide Mini-Band Application Tool

- Size and Weight: 8.75" L x 1.52 lbs.
- Calibration Range: 62–82 lbs.
- Hose Length: 10' Extended
- Cut-off blade: replaceable with DBS-1200-7



DBS-RO3 ROLL-OVER FOR .250 WIDE BANDS APPLICATION TOOL

The DMC Roll-Over Tool (Part No. **DBS-RO3**) is used to fold the extended band tab securely over the buckle. Experts agree that the "folded tab" method assures maximum strength and reliability. Like other DMC Band Application Tools, the Roll-Over Tool is compatible with all currently available bands.

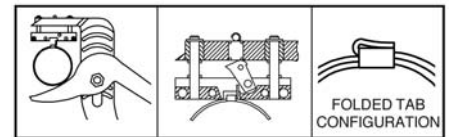

DMC also provides the **DBS-RO5** Roll-Over Tool for use with .125 wide Mini-Bands. This tool is similar to the DBS-RO3 in size and shape.

CALIBRATION OF EMI/RFI BAND TOOLS

All the DMC Hand and Pneumatic Band Application Tools may be calibrated to insure correct band tension. The **DBS-CG1 Calibration Instrument** will allow the operator to gage the exact tension produced by the tool.

A short piece of unused band material is fed into the tool far enough to fully engage the gripping mechanism. The other end is then inserted and latched into the calibration instrument. Full tension is exerted by the tool and read directly on the precision dial indicator portion of the calibration instrument. Simple adjustments can be made to the tool as needed. A quick release mechanism is provided to allow the operator to easily remove the tool from the calibration instrument. A free standing holding fixture is available (**DBS-CG1-F**) to aid



the calibration process by securing the calibration instrument and banding tool in place.

Field Calibration Fixtures and **Go/No-Go Gages** were developed to allow the user a quick means of checking calibration of band application tools in the field. A band is placed into the calibration fixture.

The band is drawn through the tool until the nose of the banding tool is firmly against the field calibration fixture. Once the full banding pressure has been applied, insert the "GO" side of the Gage into the verification slot of the field calibration fixture. If it does not insert freely, the tool is exerting excessive force. Likewise, if the NO-GO probe freely enters the verification slot, the tool is below the minimum force, thus alerting the user that the tool is out of calibration.



EMI/RFI BAND APPLICATION SYSTEM

FOR .125 & .250 SHIELD TERMINATION BANDS



BANDING TOOL KITS

DMC1379 – .250 Banding Tool Kit.

This kit includes the tools necessary to install and remove termination bands, plus a total of 50, 1/4" terminator bands, packaged in a fiberglass case with pre-cut foam inserts and laminated instruction charts.

DMC60A – Complete EMI/RFI

Shielding Maintenance Repair System. This kit includes a complete complement of tools to install and remove shield termination material and specialized tapes. Instructions are included to guide the user through all steps of repair from correct tool selection, to set-up and operation of tools and components. It is packaged in a fiberglass case with foam inserts for designated tool storage. It includes calibration fixture and gauge.

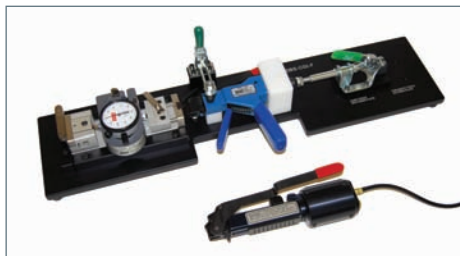

The **DBS-CG1-F** holding fixture secures the calibration instrument and banding tool in place during calibration. This fixture only works with the DBS-CG1 Calibration Instrument. (Banding tools and DBS-CG1 are sold separately.)

APPLICATION TOOLS, ACCESSORIES AND COMPONENTS

.250 WIDTH BAND TOOLS

DBS-1100	Hand Operated Band Application Tool
DBS-1101	Hand Operated Band Application Tool Set (includes DBS-1100, DBS-R03)
DBS-1102	Hand Operated Band Application Tool Set (includes DBS-1100, DBS-R03, DBS-CG2 & G691)
DBS-1100-32	Calibration Adjustment Key
DBS-1100-7	Replacement Blade for .250 Band Tools
DBS-R03	Roll-Over Tool for .250 Band Tab

.125 WIDTH MINI-BAND TOOLS

DBS-1200	Hand Operated Mini Band Tool
DBS-1201	Hand Operated Mini Band Application Tool Set (includes DBS-1200, DBS-R04)
DBS-1202	Hand Operated Mini Band Application Tool Set (includes DBS-1200, DBS-R04, DBS-CG3 & G752)
DBS-1100-7	Replacement Blade for .125 Band Tools
DBS-R05	Roll-Over Tool for .125 Band Tab

PNEUMATIC BAND TOOLS FOR .250 WIDTH BANDS

PBT1100	Pneumatic Band Application Tool
---------	---------------------------------

PNEUMATIC BAND TOOLS FOR .125 WIDTH BANDS

PMBT1200	Pneumatic Band Application Tool
----------	---------------------------------

TOOL CALIBRATION INSTRUMENTATION

DBS-CG1	Laboratory Calibration Instrument (all tools)
DBS-CG1-F	DBS-CG1 Holding Fixture (Banding tool & DBS-CG1 not included)
DBS-CG2	Field Calibration Fixture for DBS-1100
G691	Go/No-Go Gage for DBS-CG2 Fixture
DBS-CG2A	Calibration Set which includes DBS-CG2 & G691
DBS-CG3	Field Calibration Fixture for DBS-1200
G752	Go/No-Go Gage for DBS-CG3 Fixture
DBS-CG3A	Calibration Set which includes DBS-CG3 & G752

BANDING APPLICATION KIT

DMC1379	.250 Banding Tool Kit
DMC60A	Complete EMI/RFI Shielding Maintenance/Repair System (.250 bands and tools)

BANDS & RINGS

4-1380	.250 wide x 14.0 long EMI/RFI Band (Flat)*
4-1553	.125 wide x 14.0 long EMI/RFI Band (Flat)*
4-1376	.500 Dia. Split Ring Set
4-1377	.750 Dia. Split Ring Set
4-1378	1.00 Dia. Split Ring Set
4-1379	1.50 Dia. Split Ring Set

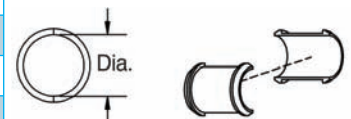

Patent information: Tools featured on this data sheet are covered all or in part by the following patents: 4,934,416 – 5,000,232 – 4,996,868 - 5,111,853 – 5,172,737 – 5,154,210
* Band can also be supplied curled (contact factory)

Careful measurement should be made prior to installing the backshell. The outer jacket is then uniformly removed at a distance which would allow the braid to make a comfortable transition onto the backshell termination area. This dimension will vary depending upon the differences between cable and backshell diameters or other application dependent factors.

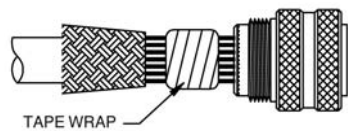
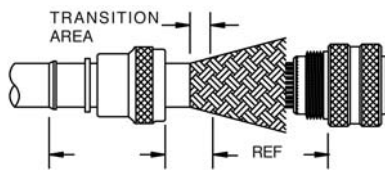

expose the wires which will be inside the backshell.

A sufficient number of wraps of self-vulcanizing tape (normally red in color) are applied over the wires to build up a diameter slightly less than the inside diameter of the backshell. Care should be taken not to apply tension to the contacts located in the outer perimeter of the connector.

These layers of tape are followed by a minimum of one layer of Teflon tape which will prevent adhesion with the backshell and other components.

The backshell is then installed onto the connector, using a nonabrasive tool such as a strap wrench. The braid is then carefully moved from under the backshell. It is important to retain the woven characteristics of the braid during this step.

Use self-vulcanizing tape or a preformed component to build up the area behind the

The braid is then trimmed to a length which will allow it to extend 1 inch past the backshell termination platform. Then the braid is carefully folded rearward to

expose the wires which will be inside the backshell.

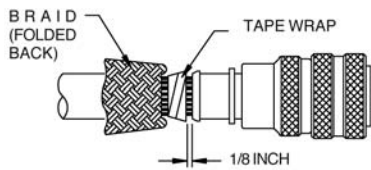
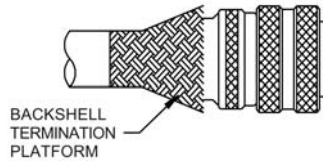

backshell. It is important that the braid is supported in the transition from the backshell rear diameter to the natural diameter of the wire bundle. Leave

approximately 1/8 inch spacing between the tape wrap and the backshell.

The braid is pushed into position over the backshell termination platform. Care must be taken to make sure the weave is uniform and no large "windows" are present. A shield termination



band is then loaded into the tool. The band is then slid over the connector/backshell assembly into a position of alignment with the termination platform. Apply an adequate amount of pressure in line with the cable as it enters the backshell to allow the 1/8 inch space to be reduced to zero. The tool is then activated to the preset tension. The band is then bent sharply at the buckle approximately 90° then cut-off using the cut-off lever on the tool. If the band is uncurled for any reason, it must be double looped thru the buckle before termination.

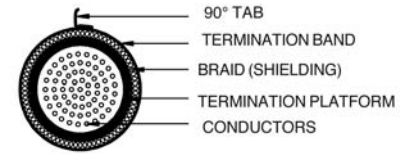

The 90° tab is then curled and folded back over the buckle using the rollover tool.

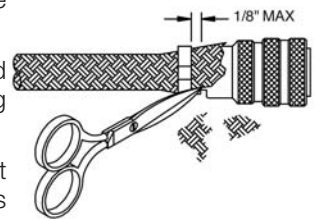

For braiding a non-jacket cable use fine point shears to trim the excess braid as close to the connector side of the bands as possible. Do not leave any unsecured braid wires longer than 1/8 inch. Do not allow the trimmed wires to fall in any areas where they may present a foreign object damage hazard.

PROCEDURE FOR SPLICING

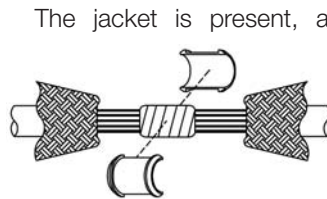

The jacket is present, and shield has been cut and separated to expose the wires requiring service. Care must be taken to avoid damaging the insulation on internal wires. The required service is then completed.

The wire bundle is then protected by a few wraps of self-vulcanizing tape followed by 2-3 layers of teflon tape. An appropriate-size split-ring set is then selected and installed. One layer of teflon tape is applied over the split ring set to hold the halves in position while the next steps are being performed.

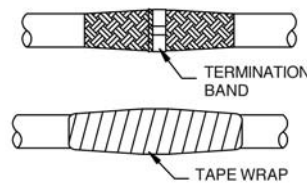
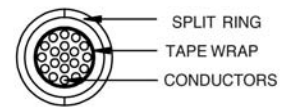
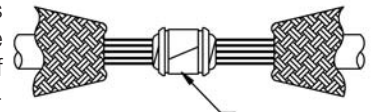

The braid is then overlapped across the split ring set. Be sure the braid ends protrude completely under the band in both directions.

Heat-shrinkable tape is then applied over the splice. When a jacketed cable is used, be sure the tape extends onto the jacket in both directions.

BETA ADAPTOR KITS

*Kit configuration may vary from example shown.
Configuration depends on application, user requirements,
and packaging needs of the customer.*



BETA ADAPTOR TOOL KITS
MORE THAN JUST A BOX OF TOOLS!

DMC's Adaptor Tool Kits are designed to keep your BETA tools organized and provide all the necessary information concerning the selection and use of the tooling. A collection of tools and accessories are packaged in a well organized case or cabinet. And the complete support data package makes a DMC Kit more than just a box of tools.

DMC has designed and manufactured system service kits longer than anyone in the connector tooling industry. This experience has enabled DMC the capabilities to design a wiring system service kit for virtually any electrical interconnect system. DMC Kits have proven their reliability and versatility over years of dependable service to the manufacturing and MRO industries.

We offer an extensive line of maintenance/repair kits, production (work station) kits, and tool sets, many of which contain tools from the BETA product line. For a listing of wiring system maintenance tool kits, or assistance with your individual requirements, contact DMC.

Many BETA Backshell Tools are available with other DMC products in existing DMC Wiring System Service Kits or in a different configuration than those shown. Please consult the factory for your specific requirements.



AS85049 CONNECTOR ACCESSORIES

QUICK REFERENCE GUIDE

SPECIFICATION	TITLE	APPLICATION	PAGE
AS85049/1	Backshell, Environmental, Cable Sealing, Straight, Grounding (Without Strain Relief), Category 1C	AS50151 Solder Type, V Thread of MS310X, Classes A, B, C or K Connectors	6
AS85049/2	Backshell, Environmental, Cable Sealing, Straight, Category 1C	AS50151 Solder Type, V Thread of MS310X, Classes A, B, C or K Connectors	6
AS85049/3	Backshell, Cable Sealing, Straight, Category 1A	MIL-DTL-22992 Connectors, Classes C, J, and R	7
AS85049/4	Backshell, Cable Sealing, Straight, Step-Up, Category 1A	MIL-DTL-22992 Connectors, Classes C, J, and R	7
AS85049/5	Backshell, Cable Sealing, Straight, Step-Down, Category 1A	MIL-DTL-22992 Connectors, Classes C, J, and R	7
AS85049/6	Backshell, Environmental, Cable Sealing, 45°, Shield Termination, Category 1A	AS50151 Crimp, MIL-DTL-26482 Series 2, AS81703 Series 3, and MIL-DTL-83723 Series III Connectors	9, 20
AS85049/7	Backshell, Environmental, Cable Sealing, 45°, Category 1A	AS50151 Crimp, MIL-DTL-26482 Series 2, AS81703 Series 3, and MIL-DTL-83723 Series III Connectors	9, 20
AS85049/8	Backshell, Environmental, Cable Sealing, 90°, Shield Termination, Category 1A	AS50151 Crimp, MIL-DTL-26482 Series 2, AS81703 Series 3, and MIL-DTL-83723 Series III Connectors	9, 20
AS85049/9	Backshell, Environmental, Cable Sealing, 90°, Category 1A	AS50151 Crimp, MIL-DTL-26482 Series 2, AS81703 Series 3, and MIL-DTL-83723 Series III Connectors	9, 20

SPECIFICATION	TITLE	APPLICATION	PAGE
AS85049/10	Backshell, Environmental, Cable Sealing, Straight, Shield Termination, Category 1A	AS50151 Crimp, MIL-DTL-26482 Series 2, AS81703 Series 3, and MIL-DTL-83723 Series III Connectors	9, 20
AS85049/11	Backshell, Environmental, Cable Sealing, Straight, Category 1A	AS50151 Crimp, MIL-DTL-26482 Series 2, AS81703 Series 3, and MIL-DTL-83723 Series III Connectors	9, 20
AS85049/14	Backshell, Straight, Non-Self-Locking and Self-Locking, Category 3B	MIL-DTL-38999 Series III and IV Connectors	14, 15
AS85049/15	Strain Relief, 45°, Non-Self-Locking and Self-Locking, Category 4C	MIL-DTL-38999 Series III and IV Connectors	14, 15
AS85049/16	Strain Relief, 90°, Non-Self-Locking and Self-Locking, Category 4C	MIL-DTL-38999 Series III and IV Connectors	14, 15
AS85049/17	Backshell, Environmental, Straight, Shield Termination, Category 2B	MIL-DTL-38999 Series I and II Connectors	12, 13
AS85049/18	Backshell, Environmental, Straight, RFI/EMI, Category 2B	MIL-DTL-38999 Series III and IV Connectors	14, 15
AS85049/19	Backshell, Nonenvironmental, Straight, RFI/EMI, Category 3B	MIL-DTL-38999 Series III and IV Connectors	14, 15
AS85049/20	Backshell, Straight, RFI, EMI, Category 3B	MIL-DTL-38999 Series III and IV Connectors	14, 15
AS85049/21	Backshell, Nonenvironmental, Straight, Category 3B	MIL-DTL-38999 Series III and IV Connectors	14, 15
AS85049/23	Backshell, Nonenvironmental, 45°, Shield Termination, Category 3A	AS50151 Crimp, MIL-DTL-26482 Series 2, AS81703 Series 3, and MIL-DTL-83723 Series III Connectors	9, 20
AS85049/24	Backshell, Nonenvironmental, 90°, Shield Termination, Category 3A	AS50151 Crimp, MIL-DTL-26482 Series 2, AS81703 Series 3, and MIL-DTL-83723 Series III Connectors	9, 20



DMC does NOT provide connectors, backshells, accessories, or wiring components. Parts shown here are for reference only.

SPECIFICATION	TITLE	APPLICATION	PAGE
AS85049/25	Backshell, Nonenvironmental, Straight, Shield Termination, Category 3A	AS50151 Crimp, MIL-DTL-26482 Series 2, AS81703 Series 3, and MIL-DTL-83723 Series III Connectors	9, 20
AS85049/26	Backshell, Nonenvironmental, Straight, Shield Termination, Category 3A	AS50151 Crimp, MIL-DTL-26482 Series 2, AS81703 Series 3, and MIL-DTL-83723 Series III Connectors	9, 20
AS85049/27	Backshell, Nonenvironmental, Straight, Self-Locking and Non-Self-Locking, Category 3B	MIL-DTL-38999 Series I and II Connectors	12, 13
AS85049/28	Backshell, Nonenvironmental, Straight, Shield Termination, Category 3B	MIL-DTL-83733 Connectors	N/A
AS85049/29	Backshell, Nonenvironmental, Straight, Category 3B	MIL-DTL-38999 Series I and II Connectors	12, 13
AS85049/30	Backshell, Nonenvironmental, Straight, Individual Shielded Wire Termination, Category 3B	MIL-DTL-38999 Series I and II Connectors	12, 13
AS85049/31	Backshell, Nonenvironmental, Straight, Self-Locking and Non-Self-Locking, Category 3B	AS50151 Crimp, MIL-DTL-26482 Series 2, AS81703 Series 3, and MIL-DTL-83723 Series III Connectors	9, 20
AS85049/32	Backshell, Nonenvironmental, 90°, Shield Termination, Category 7	MIL-DTL-38999 Series I and II Connectors	12, 13
AS85049/33	Backshell, Nonenvironmental, Straight, Shield Termination, Category 7	MIL-DTL-38999 Series I and II Connectors	12, 13
AS85049/34	Backshell, Nonenvironmental, Threaded Adapter, Category 7	MIL-DTL-26482 Series I Jam Nut Receptacle Connector (Inactive for New Design Equipment or Modification of Existing Equipment)	9
AS85049/36	Backshell, Nonenvironmental, Straight, EMI/RFI Shield Termination, Category 3B	MIL-DTL-27599 Series 1 and MIL-DTL-38999 Series I and II Connectors	12, 14
AS85049/37	Backshell, Nonenvironmental, Split 90°, EMI/RFI Shield Termination, Category 3B	MIL-DTL-38999 Series I and II Connectors	12, 13

SPECIFICATION	TITLE	APPLICATION	PAGE
AS85049/38	Strain Relief, Straight, Self-Locking and Non-Self-Locking Category 4C	MIL-DTL-38999 Series III and IV Connectors	14, 15
AS85049/39	Strain Relief, 90°, Self-Locking and Non-Self-Locking Category 4C	MIL-DTL-38999 Series III and IV Connectors	14, 15
AS85049/41	Nonenvironmental, Strain Relief, Straight, Category 4C	AS50151 Solder Type, V Thread of MS310X, Classes A, B, C or K Connectors	6
AS85049/42	Nonenvironmental, Strain Relief, Straight, Category 4A	AS50151 Solder Type, V Thread of MS310X, Classes A, B, C or K Connectors	6
AS85049/43	Strain Relief, Nonenvironmental, Self-Locking and Non-Self-Locking, 45°, Category 4B	AS50151 Crimp, MIL-DTL-26482 Series 2, AS81703 Series 3, and MIL-DTL-83723 Series III Connectors	6, 9, 20
AS85049/44	Strain Relief, Straight, Category 4C	MIL-DTL-83733 Rectangular Connectors	N/A
AS85049/45	Strain Relief, Straight, Nonmetallic, Category 4C	MIL-DTL-27599 Series I and MIL-DTL-38999 Series I and II Connectors	12, 13
AS85049/46	Strain Relief, 90°, Nonmetallic, Category 4C	MIL-DTL-27599 Series I and MIL-DTL-38999 Series I and II Connectors	12, 13
AS85049/47	Strain Relief, 90°, Self-Locking and Nonself-Locking, Category 4C	MIL-DTL-38999 Series I and II Connectors	12, 13
AS85049/48	Strain Relief, Straight, Category 7	MIL-DTL-24308 Rectangular Connectors	N/A
AS85049/49	Strain Relief, Straight, Self-Locking and Nonself-Locking, Category 4C	MIL-DTL-38999 Series I and II Connectors	12, 13
AS85049/50	Strain Relief, 90°, Category 7	MIL-DTL-24308 Rectangular Connectors	N/A
AS85049/51	Strain Relief, Nonenvironmental, 90°, Self-Locking and Non-Self-Locking, Category 4B	AS50151 Crimp, MIL-DTL-26482 Series 2, AS81703 Series 3, and MIL-DTL-83723 Series III Connectors	6, 9, 20



DMC does NOT provide connectors, backshells, accessories, or wiring components. Parts shown here are for reference only.

AS85049 CONNECTOR ACCESSORIES

QUICK REFERENCE GUIDE

SPECIFICATION	TITLE	APPLICATION	PAGE
AS85049/52	Strain Relief, Nonenvironmental, Straight, Self-Locking and Non-Self-Locking, Category 4B	AS50151 Crimp, MIL-DTL-26482 Series 2, AS81703 Series 3, and MIL-DTL-83723 Series III Connectors	6, 9, 20
AS85049/53	Strain Relief, Nonenvironmental, Straight, Category 4C	AS50151 Crimp, MIL-DTL-26482 Series 2, AS81703 Series 3, and MIL-DTL-83723 Series III Connectors	6, 9, 20
AS85049/54	Strain Relief, Nonenvironmental, 45°, Category 4C	AS50151 Crimp, MIL-DTL-26482 Series 2, AS81703 Series 3, and MIL-DTL-83723 Series III Connectors	6, 9, 20
AS85049/55	Strain Relief, Nonenvironmental, 90°, Self-Locking and Non-Self-Locking, Category 4C	AS50151 Crimp, MIL-DTL-26482 Series 2, AS81703 Series 3, and MIL-DTL-83723 Series III Connectors	6, 9, 20
AS85049/56	Strain Relief, Straight, Category 4C	MIL-DTL-38999 Series I and II Connectors	12, 13
AS85049/57	Strain Relief, 45°, Self-Locking and Nonself-Locking, Category 4C	MIL-DTL-38999 Series I and II Connectors	12, 13
AS85049/58	Ring, Potting Boot, Category 5	MIL-DTL-38999 Series I and II Connectors	12, 13
AS85049/59	Adapter, Shrink Boot, Category 5	MIL-DTL-22992 Connectors, Classes C, J, and R	7
AS85049/60	Adapter, Shrink Boot, Category 5	AS50151 Crimp, MIL-C-26482 Series 2, AS81703 Series 3, and MIL-DTL-83723 Series III Connectors	6, 9, 20
AS85049/61	Ring, Potting Boot, Category 5	MIL-DTL-27599 Connectors	N/A
AS85049/62	Adapter, Shrink Boot, Category 5	MIL-DTL-38999 Series I and II Connectors	12, 13
AS85049/63	Strain Relief, 90°, Self-Locking and Nonself-Locking, Category 4C	MIL-DTL-38999 Series I and II Connectors	12, 13
AS85049/64	Strain Relief, Split, Straight, Category 4C	MIL-DTL-38999 Series I and II Connectors	12, 13

SPECIFICATION	TITLE	APPLICATION	PAGE
AS85049/65	Strain Relief, Split 90°, Category 4C	MIL-DTL-38999 Series I and II Connectors	12, 13
AS85049/69	Adapter, Shrink Boot, Category 5	MIL-DTL-38999 Series III and IV Connectors	14, 15
AS85049/74	Potting Boot, Category 7	Use With AS85049/61 Potting Boot Ring	N/A
AS85049/75	Potting Boot, Category 7	Use With AS85049/58 Potting Boot Ring	N/A
AS85049/76	Backshell, Environmental, 90°, Shield Termination, Category 2B, Nonself-Locking	MIL-DTL-38999 Series I and II Connectors	12, 13
AS85049/77	Backshell, Environmental, 45°, Shield Termination, Category 2B, Nonself-Locking	MIL-DTL-38999 Series I and II Connectors	12, 13
AS85049/78	Backshell, Environmental, 45°, Shield Termination, Category 2B, Nonself-Locking	MIL-DTL-38999 Series III and IV Connectors	14, 15
AS85049/79	Backshell, Environmental, 90°, Shield Termination, Category 2B, Nonself-Locking	MIL-DTL-38999 Series III and IV Connectors	14, 15
AS85049/80	Dummy Contact, Sizes 12 and 8, Category 7	MIL-DTL-38999 Connectors	12, 13, 14, 15
AS85049/81	Seal Plug, Size 10, Category 7	MIL-DTL-38999 Connectors	12, 13, 14, 15
AS85049/82	Backshell, Straight, Self-Locking, Non Self-Locking, Shield Band Termination (RFI/EMI), Shrink Sleeve Accommodation, Category 3B	AS50151 Crimp, MIL-DTL-26482 Series 2, AS81703 Series 3, and MIL-DTL-83723 Series III Connectors	6, 9, 20
AS85049/83	Backshell, 45°, Self-Locking, Non Self-Locking, Shield Band Termination, (RFI/EMI), Shrink Sleeve Accommodation, Category 3B	AS50151 Crimp, MIL-DTL-26482 Series 2, AS81703 Series 3, and MIL-DTL-83723 Series III Connectors	6, 9, 20
AS85049/84	Backshell, 90°, Self-Locking, Non Self-Locking, Shield Band Termination, (RFI/EMI), Shrink Sleeve Accommodation, Category 3B	AS50151 Crimp, MIL-DTL-26482 Series 2, AS81703 Series 3, and MIL-DTL-83723 Series III Connectors	6, 9, 20
AS85049/85	Backshell, Straight, Self-Locking, Non Self-Locking, Shield Band Termination, (RFI/EMI), Shrink Boot Accommodation, Category 3B	MIL-DTL-38999 Series I and II Connectors	12, 13



Shorting Cap Backshell

Protective Cover and Lanyard



Dummy Contacts
(Ref: AS85049/80)



DMC does NOT provide connectors, backshells, accessories, or wiring components. Parts shown here are for reference only.

SPECIFICATION	TITLE	APPLICATION	PAGE
AS85049/86	Backshell, 45°, Self-Locking, Non Self-Locking, Shield Band Termination, (RFI/EMI), Shrink Sleeve Accommodation, Category 3B	MIL-DTL-38999 Series I and II Connectors	12, 13
AS85049/87	Backshell, 90°, Self-Locking, Non Self-Locking, Shield Band Termination, (RFI/EMI), Shrink Sleeve Accommodation, Category 3B	MIL-DTL-38999 Series I and II Connectors	12, 13
AS85049/88	Backshell, Straight, Self-Locking, Non Self-Locking, Shield Band Termination, (RFI/EMI), Shrink Boot Accommodation, Category 3B	MIL-DTL-38999 Series III and IV Connectors	14, 15
AS85049/89	Backshell, 45°, Self-Locking, Non Self-Locking, Shield Band Termination, (RFI/EMI), Shrink Sleeve Accommodation, Category 3B	MIL-DTL-38999 Series III and IV Connectors	14, 15
AS85049/90	Backshell, 90°, Self-Locking, Non Self-Locking, Shield Band Termination, (RFI/EMI), Shrink Sleeve Accommodation, Category 3B	MIL-DTL-38999 Series III and IV Connectors	14, 15
AS85049/91	Strain Relief, Straight, Self-Locking, Category 4C	MIL-DTL-38999 (Composite) Series III and IV Connectors	14, 15
AS85049/92	Strain Relief, 90°, Self-Locking, Category 4C	MIL-DTL-38999 (Composite) Series III and IV Connectors	14, 15
AS85049/93	Termination, Shield, Split Support Ring, Composite, Nonenvironmental, Straight, Category 7	General Use	N/A
AS85049/94	Mounting Device, Flange Type, Full Perimeter, Medium/Light Duty, Category 7	General Use	N/A
AS85049/95	Mounting Device, Flange Type, 3/4 Mounting Perimeter, Medium/Light Duty, Category 7	General Use	N/A

SPECIFICATION	TITLE	APPLICATION	PAGE
AS85049/96	Mounting Device, Flange Type, 1/4 Mounting Perimeter, Medium/Light Duty, Category 7	General Use	N/A
AS85049/103	RFI/EMI, Electrical, Strain Relief, Straight, Self-Locking, Category 3C	MIL-DTL-38999 (Composite) Series III and IV Connectors	14, 15
AS85049/104	RFI/EMI, Electrical, Strain Relief, 45°, Self-Locking, Category 3C	MIL-DTL-38999 (Composite) Series III and IV Connectors	14, 15
AS85049/105	RFI/EMI, Electrical, Strain Relief, 90°, Self-Locking, Category 3C	MIL-DTL-38999 (Composite) Series III and IV Connectors	14, 15
AS85049/109	Backshell, Straight, Non Self-Locking, Self-Locking, Pre-Attached Shield Termination (RFI/EMI), Boot Accommodation, Category 3B	AS50151 Crimp, MIL-DTL-26482 Series 2, AS81703 Series 3, and MIL-DTL-83723 Series III Connectors	6, 9, 20
AS85049/111	Backshell, 90°, Non Self-Locking, Self-Locking, Pre-Attached Shield Termination (RFI/EMI), Boot Accommodation, Category 3B	AS50151 Crimp, MIL-DTL-26482 Series 2, AS81703 Series 3, and MIL-DTL-83723 Series III Connectors	6, 9, 20
AS85049/112	Backshell, Straight, Non Self-Locking, Self-Locking, Pre-Attached Shield Termination (RFI/EMI), Boot Accommodation, Category 3B	MIL-DTL-38999 Series I and II Connectors	12, 13
AS85049/114	Backshell, 90°, Non Self-Locking, Self-Locking, Pre-Attached Shield Termination (RFI/EMI), Boot Accommodation, Category 3B	MIL-DTL-38999 Series I and II Connectors	12, 13
AS85049/115	Backshell, Straight, Non Self-Locking, Self-Locking, Pre-Attached Shield Termination (RFI/EMI), Boot Accommodation, Category 3B	MIL-DTL-38999 Series III and IV Connectors	14, 15
AS85049/117	Backshell, 90°, Non Self-Locking, Self-Locking, Pre-Attached Shield Termination (RFI/EMI), Boot Accommodation, Category 3B	MIL-DTL-38999 Series III and IV Connectors	14, 15



Jam Nut for Panel Mount Connectors

Nut Plate for Mounting Connectors

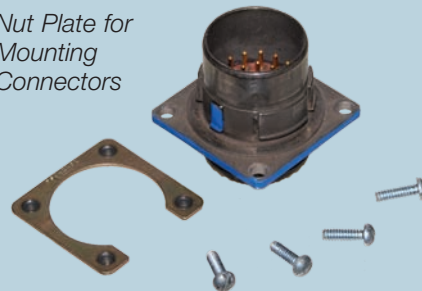

Right Angle EMI Shielded Backshell

DMC does NOT provide connectors, backshells, accessories, or wiring components. Parts shown here are for reference only.

AS85049 CONNECTOR ACCESSORIES

QUICK REFERENCE GUIDE

SPECIFICATION	TITLE	APPLICATION	PAGE
AS85049/118	Backshell, Strain Relief, Straight, Self-Locking, Non Self-Locking, Category 4B	AS50151 Crimp, MIL-DTL-26482 Series 2, AS81703 Series 3, and MIL-DTL-83723 Series III Connectors	6, 9, 20
AS85049/120	Backshell, Strain Relief, 90°, Self-Locking, Non Self-Locking, Category 4B	AS50151 Crimp, MIL-DTL-26482 Series 2, AS81703 Series 3, and MIL-DTL-83723 Series III Connectors	6, 9, 20
AS85049/121	Backshell, Strain Relief, Straight, Self-Locking, Non Self-Locking, Category 4C	MIL-DTL-38999 Series I and II Connectors	12, 13
AS85049/123	Backshell, Strain Relief, 90°, Self-Locking, Non Self-Locking, Category 4C	MIL-DTL-38999 Series I and II Connectors	12, 13
AS85049/124	Backshell, Strain Relief, Straight, Self-Locking, Non Self-Locking, Category 4C	MIL-DTL-38999 Series III and IV Connectors	14, 15
AS85049/126	Backshell, Strain Relief, 90°, Self-Locking, Non Self-Locking, Category 4C	MIL-DTL-38999 Series III and IV Connectors	14, 15
AS85049/127	Bushing Strip, Category 7	Use With SAE AS85049/118, /120, /121, /123, /124, and /126 Accessories	N/A
AS85049/128	Backshell, Shield Band, Category 7	Use With SAE AS85049/82 - /90, /109 - /117 Accessories, and General Use	42 - 45

SPECIFICATION	TITLE	APPLICATION	PAGE
AS85049/130	Gasket Material, Conductive, Non Conductive, Flange Mount, Category 7	General Use	N/A
AS85049/131	Connector Accessories, Fiber Optic, Straight, Self-Locking, Category 3B	MIL-DTL-38999 Series III and AS5590/1 Connectors	14
AS85049/132	Connector Accessories, Fiber Optic, 45°, Self-Locking, Category 3B	MIL-DTL-38999 Series III and AS5590/1 Connectors	14
AS85049/133	Connector Accessories, Fiber Optic, 90°, Self-Locking, Category 3B	MIL-DTL-38999 Series III and AS5590/1 Connectors	14
AS85049/134	Connector Accessories, Fiber Optic, Filler Plug, Category 7	Fiber Optic Connectors and Systems	N/A
AS85049/135	Connector Accessories, Fiber Optic, Split, Straight, Self-Locking, Category 3B	MIL-DTL-38999 Series III and AS5590/1 Connectors	14
AS85049/136	Connector Accessories, Fiber Optic, Split, 45°, Self-Locking, Category 3B	MIL-DTL-38999 Series III and AS5590/1 Connectors	14
AS85049/137	Connector Accessories, Fiber Optic, Split, 90°, Self-Locking, Category 3B	MIL-DTL-38999 Series III and AS5590/1 Connectors	14
AS85049/138	Cap, Dust, Plastic, Category 9	General Use	N/A
AS85049/139	Bushing, Cable Clamp to Cable, Telescoping For AS85049 Cable Clamps, Category 9	General Use	N/A
AS85049/140	Boots, Heat-Shrinkable, Straight, Category 9	General Use	N/A
AS85049/141	Boots, Heat-Shrinkable, 90°, Category 9	General Use	N/A
AS85049/142	Boots & Sleeves, Transitions, Heat-Shrinkable, Category 9	General Use	N/A

Band Termination System



EMI Shielded Backshells for Rectangular Connectors

Shield Termination Bands (Ref: AS85049/128)



DMC does NOT provide connectors, backshells, accessories, or wiring components. Parts shown here are for reference only.

SUGGESTED TORQUE VALUES



Daniels Manufacturing Corp takes no responsibility for the suggested torque values stated on this page. They were obtained from members of SAE Technical Standards Committee (AE-8C1, Connectors and Accessories), and will be published in a technical standard which is under development in the committee. If you need more information, contact DMC for the latest status on the ARP***** Torque for Wiring System Components Standard.

Torque values used to assemble connectors, backshells, and other wiring system components are the responsibility of the user/installer to determine the best torque range for the application. It is also the responsibility of the user/installer to select the appropriate tool for the work and the user conditions/environment.

CIRCULAR ELECTRICAL CONNECTOR ACCESSORIES SUGGESTED TORQUE VALUES		
SHELL SIZES	GROUP 1 (±5 IN-LBS) Light & Medium Duty AS50151 (MS3100 Series) MIL-DTL-26482 Series I MIL-DTL-26500 MIL-DTL-27599 MIL-DTL-38999 Series I, II MIL-C-81511 Series I, II, III, IV MIL-DTL-81703 Series I	GROUP 2 (±5 IN-LBS) Heavy Duty AS50151 (MS3400 Series) MIL-DTL-22992 MIL-DTL-26482 Series II MIL-DTL-28840 MIL-DTL-38999 Series III, IV MIL-DTL-81703 Series III MIL-DTL-83723 Series I, II, III
	8, 9, A	40*
3, 10, 10SL, 11, B	40*	76
7, 12, 12S, 13, C	40	108
14, 14S, 15, D	40	116
16, 16S, 17, E	40	116
18, 19, 27, F	40	116
20, 21, 37, G	80	136
22, 23, H	80	136
24, 25, 61, J	80	136
28, 29	120	148
32, 33	120	148
36	120	148
40	170	164
44	170	164
48	170	164

*Indicates 35 Inch-Pounds for composite coupling nut.
 NOTES: 1. Group 1 values based on 80% of MIL-DTL-85049 light duty thread strength.
 2. Use Group 1 values for composite connector accessories.

CABLE CLAMP SCREW SUGGESTED TORQUE VALUES	
SCREW SIZE	TORQUE (+/- .5 IN-LBS)
2-56	2
4-40	4
6-32	6
8-32	8
10-32	10
.250-20	12

JAM NUT INSTALLATION SUGGESTED TORQUE VALUES	
SHELL SIZE	INCH-POUNDS ± 5%
10	95
12	110
14	140
16	170
18	195
20	215
22	235
24	260

CAUTION: Over tightening (Torque) connectors, backshells, and other wiring system components can damage threads, metal or composite structure, or rubber components, and cause them to fail. Under-tightening (Torque) wiring system components can cause the components to loosen during use and fail.

Tightening or loosening system components beyond the specified range of a torque wrench may damage a torque wrench, and affect its accuracy and repeatability.

NOTE: For additional information about torque calculation, see page 36.

OTHER PRODUCTS FROM DMC...

Contact our knowledgeable staff of customer service application experts for details on other quality products from DMC.

DMC tools have become the standard for Military, Aircraft, Aerospace and Industrial use.

DMC can meet your needs for connector system production and maintenance, fastener retention system and test/verification equipment for compliance with SPC/ISO standards.



COMPLETE MAINTENANCE TOOL KITS



HAND OPERATED CRIMP TOOLS



ALPHATRON WIRE CRIMP PULL TESTERS



Safe-T-Cable® FASTENER RETENTION SYSTEM



PNEUMATIC CRIMP TOOLS



WIRE STRIPPERS AND REPLACEMENT BLADES



BATTERY POWERED CRIMP TOOLS

NATIONAL STOCK NUMBERS FOR BETA™ SERIES TOOLING

DMC P/N	NSN P/N	DMC P/N	NSN P/N	DMC P/N	NSN P/N	DMC P/N	NSN P/N
BT-AT-1500	5120-01-376-9839	CM288-33B	5120-01-377-4586	CM389S-8	5120-01-377-1273	CM5015R-32	5120-01-377-1333
BT-BS-601	5120-01-335-8841	CM288R-11A	5120-01-377-4603	CM389T-11A	5120-01-377-1302	CM5015R-36	5120-01-377-1298
BT-BS-609	5120-01-335-8842	CM288R-11B	5120-01-377-4534	CM389T-11B	5120-01-377-1178	CM5015R-40	5120-01-377-1316
BT-BS-610	5120-01-335-8843	CM288R-13A	5120-01-377-4545	CM389T-13A	5120-01-377-1215	CM5015R-44	5120-01-377-1202
BT-BS-611	5120-01-335-8844	CM288R-13B	5120-01-377-1327	CM389T-13B	5120-01-377-1297	CM5015R-48	5120-01-379-0200
BT-BS-618	5120-01-335-8845	CM288R-15A	5120-01-377-1269	CM389T-15A	5120-01-377-1172	CM5015R-8	5120-01-377-1238
BT-BS-625	5120-01-335-8846	CM288R-15B	5120-01-379-0154	CM389T-15B	5120-01-377-1200	CM815L-10A	5120-01-377-1312
BT-BS-630	5120-01-335-8847	CM288R-17A	5120-01-377-1182	CM389T-17A	5120-01-379-0146	CM815L-10B	5120-01-377-1264
BT-J-132	5120-01-368-4132	CM288R-17B	5120-01-377-1321	CM389T-17B	5120-01-377-1263	CM815L-14A	5120-01-377-1169
BT-ST-701	5120-01-335-8179	CM288R-19A	5120-01-377-1301	CM389T-19A	5120-01-377-4604	CM815L-14B	5120-01-377-1328
BT-ST-725	5120-01-335-8177	CM288R-19B	5120-01-377-1314	CM389T-19B	5120-01-377-1311	CM815L-16A	5120-01-377-1170
BT-ST-751	5120-01-335-8178	CM288R-23A	5120-01-377-1227	CM389T-21A	5120-01-377-1207	CM815L-16B	5120-01-377-4583
CM229-12	5120-01-377-1198	CM288R-23B	5120-01-377-1251	CM389T-21B	5120-01-377-1224	CM815L-18A	5120-01-377-4530
CM229-14	5120-01-377-1250	CM288R-25A	5120-01-377-1294	CM389T-23A	5120-01-377-1245	CM815L-18B	5120-01-377-4567
CM229-16	5120-01-377-1284	CM288R-25B	5120-01-377-1171	CM389T-23B	5120-01-377-1158	CM815L-20A	5120-01-377-1335
CM229-18	5120-01-377-1157	CM288R-29A	5120-01-377-1197	CM389T-25A	5120-01-255-7893	CM815L-20B	5120-01-377-1189
CM229-20	5120-01-377-4529	CM288R-29B	5120-01-377-1240	CM389T-25B	5120-01-377-1320	CM815L-22A	5120-01-377-4553
CM229-22	5120-01-377-1324	CM288R-33A	5120-01-377-4523	CM389T-9A	5120-01-377-1230	CM815L-22B	5120-01-377-4570
CM229-24	5120-01-377-1257	CM288R-33B	5120-01-377-1318	CM389T-9B	5120-01-379-0194	CM815L-24A	5120-01-377-1334
CM229-36	5120-01-377-1272	CM389B-11	5120-01-377-1234	CM389TR-11A	5120-01-377-1288	CM815L-24B	5120-01-377-4508
CM229-40	5120-01-377-4507	CM389B-13	5120-01-368-4117	CM389TR-11B	5120-01-379-0139	CM815L-8A	5120-01-377-4595
CM229L-28	5120-01-377-1319	CM389B-15	5120-01-368-4133	CM389TR-13A	5120-01-377-1252	CM815L-8B	5120-01-377-4543
CM229L-32	5120-01-377-1223	CM389B-17	5120-01-377-1261	CM389TR-13B	5120-01-379-0171	CM815L-10A	5120-01-377-4569
CM229L-44	5120-01-377-4578	CM389B-19	5120-01-377-1305	CM389TR-15A	5120-01-377-1188	CM815L-10B	5120-01-377-4519
CM229L-48	5120-01-377-1287	CM389B-21	5120-01-377-1208	CM389TR-15B	5120-01-379-0140	CM815S-14A	5120-01-377-4552
CM229L-52	5120-01-377-1187	CM389B-23	5120-01-377-1236	CM389TR-17A	5120-01-379-0193	CM815S-14B	5120-01-377-4581
CM264-10	5120-01-377-4551	CM389B-25	5120-01-377-1152	CM389TR-17B	5120-01-379-0191	CM815S-16A	5120-01-377-1308
CM264-12	5120-01-368-4118	CM389BR-11	5120-01-377-1186	CM389TR-19A	5120-01-379-0172	CM815S-16B	5120-01-377-1216
CM264-14	5120-01-368-4119	CM389BR-13	5120-01-377-1210	CM389TR-19B	5120-01-379-0161	CM815S-18A	5120-01-377-1310
CM264-16	5120-01-368-4120	CM389BR-15	5120-01-377-1244	CM389TR-21A	5120-01-379-0142	CM815S-18B	5120-01-377-1211
CM264-18	5120-01-377-4564	CM389BR-17	5120-01-377-1300	CM389TR-21B	5120-01-379-0180	CM815S-8	5120-01-377-1331
CM264-20	5120-01-368-4121	CM389BR-19	5120-01-377-1181	CM389TR-23A	5120-01-379-0173	CM837-10A	5120-01-368-4124
CM264-22	5120-01-377-4584	CM389BR-21	5120-01-377-1214	CM389TR-23B	5120-01-377-4535	CM837-10B	5120-01-377-1296
CM264-24	5120-01-377-4513	CM389BR-23	5120-01-377-1190	CM389TR-25A	5120-01-377-4605	CM837-12A	5120-01-377-1313
CM264-8	5120-01-377-1212	CM389BR-25	5120-01-377-1249	CM389TR-25B	5120-01-377-4568	CM837-12B	5120-01-377-1307
CM264R-10	5120-01-377-1233	CM389L-11	5120-01-377-1156	CM389TR-9A	5120-01-377-4600	CM837-14A	5120-01-368-4125
CM264R-12	5120-01-368-4123	CM389L-13	5120-01-377-1192	CM389TR-9B	5120-01-377-4527	CM837-14B	5120-01-377-1193
CM264R-14	5120-01-368-4122	CM389L-15	5120-01-377-1225	CM5015-10	5120-01-377-4562	CM837-16A	5120-01-368-4126
CM264R-16	5120-01-377-1256	CM389L-17	5120-01-377-1266	CM5015-12	5120-01-377-4602	CM837-16B	5120-01-377-1231
CM264R-18	5120-01-377-1291	CM389L-19	5120-01-377-1151	CM5015-14	5120-01-377-4536	CM837-18A	5120-01-368-4127
CM264R-20	5120-01-377-1149	CM389L-21	5120-01-377-1180	CM5015-16	5120-01-377-4547	CM837-18B	5120-01-377-1260
CM264R-22	5120-01-377-1203	CM389L-23	5120-01-368-4143	CM5015-18	5120-01-368-4147	CM837-20A	5120-01-368-4128
CM264R-24	5120-01-377-1222	CM389L-25	5120-01-368-4142	CM5015-20	5120-01-377-4587	CM837-20B	5120-01-377-1285
CM264R-8	5120-01-377-1239	CM389L-9	5120-01-377-1226	CM5015-22	5120-01-377-4526	CM837-22A	5120-01-368-4131
CM288-11A	5120-01-377-1271	CM389LR-11	5120-01-377-1259	CM5015-24	5120-01-377-4559	CM837-22B	5120-01-368-4129
CM288-11B	5120-01-377-1150	CM389LR-13	5120-01-377-1292	CM5015-28	5120-01-368-4146	CM837-24A	5120-01-368-4130
CM288-13A	5120-01-377-1179	CM389LR-15	5120-01-377-1161	CM5015-32	5120-01-377-4588	CM837-24B	5120-01-377-1162
CM288-13B	5120-01-377-1204	CM389LR-17	5120-01-377-1213	CM5015-36	5120-01-377-4518	CM837-8A	5120-01-377-1194
CM288-15A	5120-01-377-1235	CM389LR-19	5120-01-377-1267	CM5015-40	5120-01-377-1209	CM837-8B	5120-01-377-4560
CM288-15B	5120-01-377-1258	CM389LR-21	5120-01-377-1329	CM5015-44	5120-01-377-4574	CM837-8C	5120-01-377-1330
CM288-17A	5120-01-377-1332	CM389LR-23	5120-01-368-4145	CM5015-48	5120-01-377-1306	CM837-8D	5120-01-377-1147
CM288-17B	5120-01-377-1177	CM389LR-25	5120-01-368-4144	CM5015-8	5120-01-377-1201	CM837RB-10	5120-01-377-4571
CM288-19A	5120-01-377-4548	CM389LR-9	5120-01-377-1295	CM5015R-10	5120-01-377-4579	CM837RB-12	5120-01-368-4135
CM288-19B	5120-01-377-4565	CM389S-10	5120-01-377-4549	CM5015R-12	5120-01-377-4506	CM837RB-14	5120-01-368-4136
CM288-23A	5120-01-377-4609	CM389S-12	5120-01-377-4573	CM5015R-14	5120-01-368-4134	CM837RB-16	5120-01-368-4137
CM288-23B	5120-01-377-4524	CM389S-14	5120-01-377-1309	CM5015R-16	5120-01-377-1315	CM837RB-18	5120-01-368-4138
CM288-25A	5120-01-377-1326	CM389S-16	5120-01-377-1183	CM5015R-18	5120-01-377-1217	CM837RB-20	5120-01-368-4139
CM288-25B	5120-01-377-1278	CM389S-18	5120-01-377-1323	CM5015R-20	5120-01-377-1253	CM837RB-22	5120-01-368-4140
CM288-29A	5120-01-377-4514	CM389S-20	5120-01-377-1268	CM5015R-22	5120-01-368-4149	CM837RB-24	5120-01-368-4141
CM288-29B	5120-01-377-1317	CM389S-22	5120-01-377-4598	CM5015R-24	5120-01-410-7026	CM837RB-8	5120-01-377-1185
CM288-33A	5120-01-377-1243	CM389S-24	5120-01-377-1325	CM5015R-28	5120-01-377-1218		

Additional NSNs may be available, consult DMC.



**LIMITATION OF LIABILITY/
LIMITED WARRANTY***

DANIELS MANUFACTURING CORPORATION IS NOT LIABLE FOR CONSEQUENTIAL OR SPECIAL DAMAGES OF ANY NATURE OR KIND RESULTING FROM THE USE OF ANY OF ITS PRODUCTS. OWNERS AND USERS OF DMC PRODUCTS ASSUME FULL RESPONSIBILITY FOR INSTRUCTING THEIR EMPLOYEES IN THE PROPER AND SAFE USE OF SUCH PRODUCTS.

Daniels Manufacturing Corporation warrants each new unit sold by it to be free from defects in material and workmanship under normal use and service. Its obligation under this warranty is limited to the free correction or, at its option, the refund of the purchase price of any such unit which proves defective within ninety (90) days after delivery to the first user, provided that the unit is returned to it with all transportation charges prepaid, and which shall appear to its satisfaction, upon inspection by it, to have been defective in material or workmanship. This warranty shall not cover any damage to such products, which in the opinion of Daniels Manufacturing Corporation, was caused by normal wear, misuse, improper operation or accident. This warranty is in lieu of all other warranties express or implied. No warranty, express or implied, is made or authorized to be made or assumed with respect to products of Daniels Manufacturing Corporation, other than that herein set forth.

*as defined by PL93-637



DMC DANIELS
MANUFACTURING
CORPORATION

526 Thorpe Road • Orlando, Florida 32824 USA

Phone: 407-855-6161 • Fax: 407-855-6884

E-Mail: dmc@dmctools.com

WWW.DMCTOOLS.COM