

Important Note from Manufacturer: Prior to the use of this tool, the operator should take a sample of the cable they will be using and test the viability of the strip. Adjustments may be needed for desired outcome that vary from the factory setting.

This Quick Start Guide is designed to assist the operator in understanding the features, basic operation, proper use, and adjustability of the TS8000 tool. For additional information, please refer to the TS8000 manual.

Step 1: Opening Tool Arms

(1-2) Squeeze the arm release levers flush to the tool core. If the arms will not open with finger pressure, check to ensure the lock ring is not hindering movement. (3) While holding the tool arms open, rotate the lock ring to the right in the lock position. (4) Release the levers, and verify the arms are securely locked in the open position.

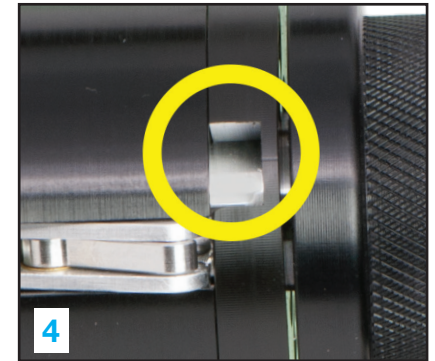
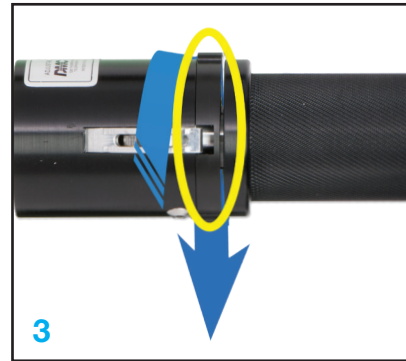

Step 2: Installing Dies

(1) Press the die release button on one tool arm, exposing the die mounting post. (2-3) Place the "A" die half onto the die mounting post of the tool arm marked "A", repeat for the "B" die half. Check to make sure the die half is fully engaged with the die mounting post. Release the die release button, and check to make sure the die half is fully retracted into the tool arm. (4) Repeat this procedure for the other tool arm.

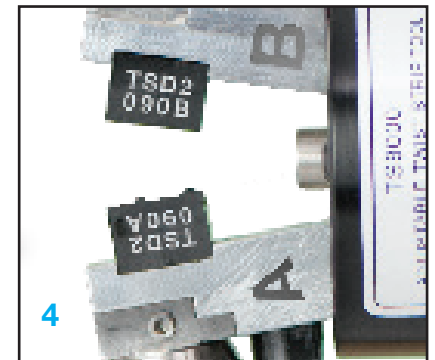
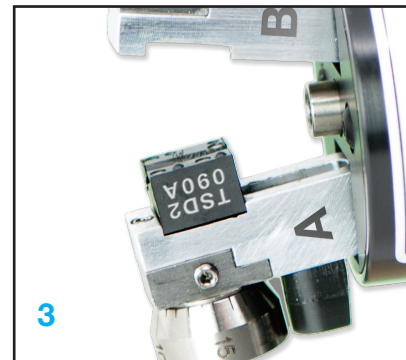
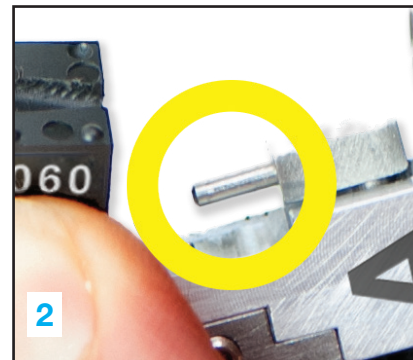

Step 3: Release Arms to Engage Tool

(1-3) While holding the Arm Release Levers as shown below, rotate the lock ring to the unlocked position. (4) Gently release the tool arms and inspect the closure of the die set. **IMPORTANT NOTE:** It is not recommended to allow the tool to snap shut.

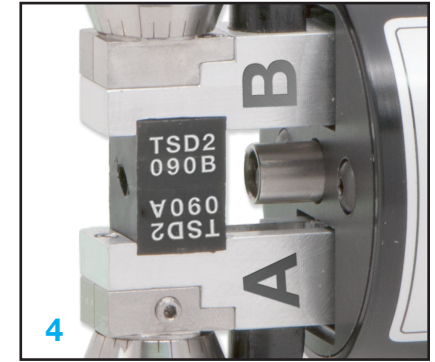
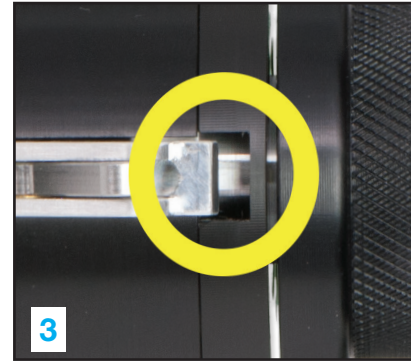
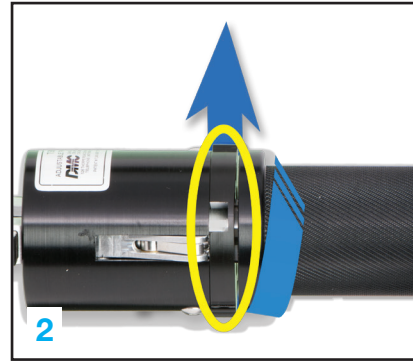

Step 4: Set Cable Strip Length

(1-3) To set the length of the strip, simultaneously grip tool core and handle, loosen the collet, adjust the strip length rod and then re-tighten the collet. The strip length rod may be completely removed for long strips, numbers and graduations on strip length gage are for reference only.

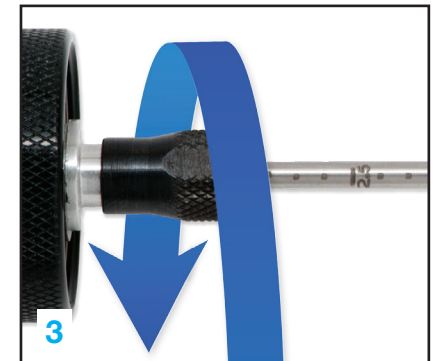
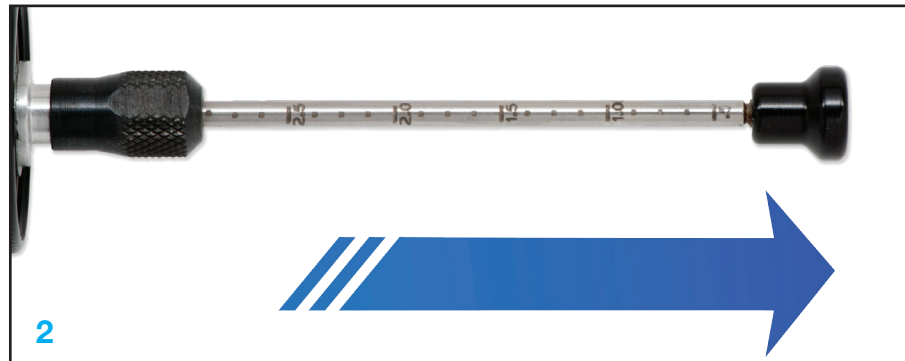
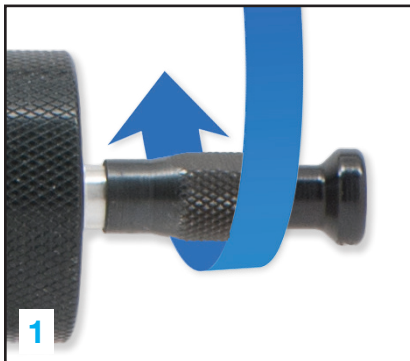

(CONTINUED ON REVERSE)

Step 5: Adjusting the Blade Depth

The TS8000 has adjustable blade depth settings. Follow these steps to set the proper blade depth for a die set: Remove Dies from Tool. (1) Unlock Depth Knob Lock Screws. (2) Turn each depth control knob clock-wise until it bottoms on the Tool Arms. Install Dies, making sure to put the die half marked “A” on the tool arm marked “A” and the die half marked “B” on the tool arm marked “B.” Looking at the die container for the installed dies, take note of the starting depth for blade adjustment on die half “A” (ex: A=.010”). Turn Depth Control Knob on Tool Arm marked “A” counterclockwise 10 marks. (3) Each hash mark on the knob represents .001” of blade travel. (4) Lock Depth Knob Lock Screw on Tool Arm marked “A”. Repeat for Die Half marked “B.” Strip sample wire and inspect for desired result, adjust tool as necessary.

NOTE: The “starting depth” for blade adjustment produces a very light score on cable jacket. Operator should adjust cutting depth to preferred depth setting.

NOTE: 3 conductor die sets have are asymmetrical. Therefore, 3 conductor die sets come with only 1 blade. The blade is in the “B” side die. This will produce a single cut longitudinally on the cable.

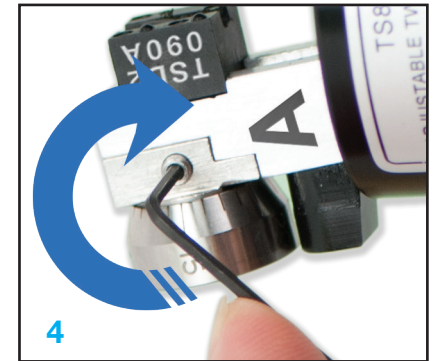
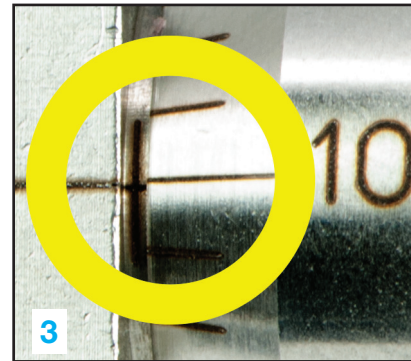
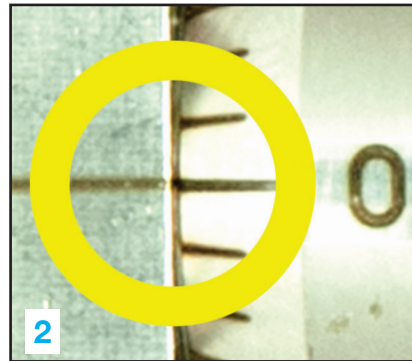
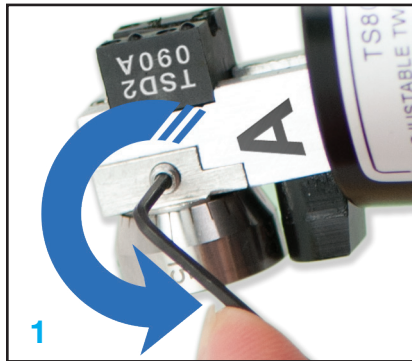

Step 6: Inserting Cable for Strip

(1) Squeeze the arm release levers to open tool arms/die set. (2-3) Insert the cable into the cable entry tube until it stops on the end of the strip length rod, and gently release tool arms until the dies are seated flush together.

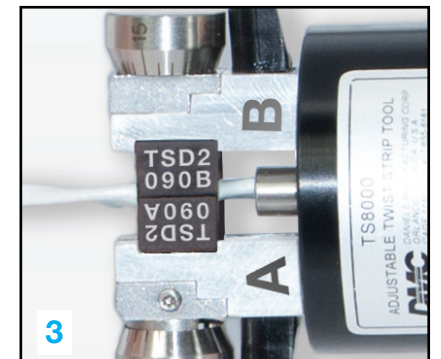
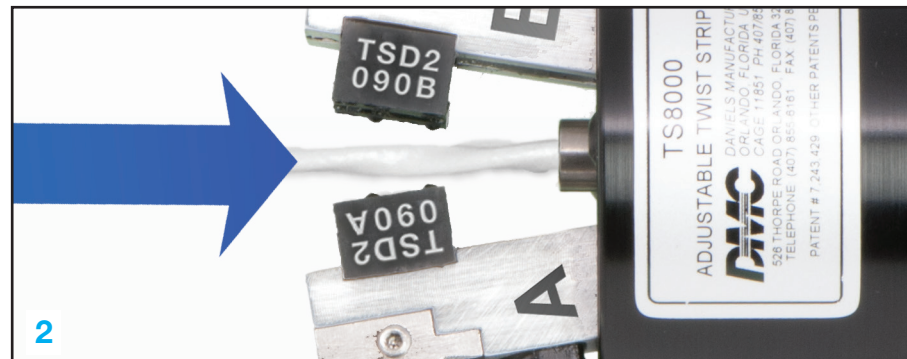

Step 7: Stripping the Cable

(1) When the dies are correctly closed around the cable, pull the cable in a smooth and in-line motion away from the tool and the blades in the die set will precisely slit the outer jacket. The user may find that scoring instead of cutting completely through the jacket produces the best results. This is acceptable.

NOTE: DO NOT pull the cable at an angle, suddenly, or with a jerking motion (2-3).

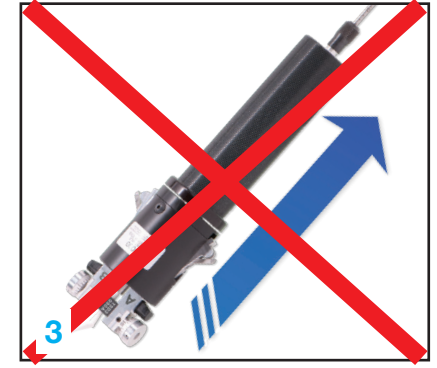
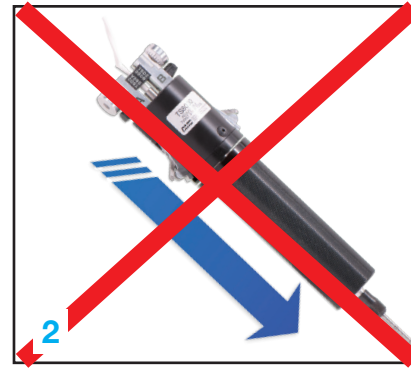

Step 8: Crack and Peel the Jacket

(1) Bend cable back and forth 90° to “crack” jacket halves apart. Peel the two halves back and trim with cable snips.

The user may find that the depths for each side are not the same in order to have good quality results. This is acceptable. (2) If the cable jacket doesn't crack apart easily, adjust the depth knob for a deeper cut. (3) If shield damage is present and undesired, adjust the depth knob for a shallower cut. A shallower cut will potentially make the jacket more difficult to crack apart.

