

PRODUCT CATALOGUE



GB



ELPRESS[®]

Business aim

“The business aim of the Elpress Group is to provide, primarily to professional users, qualified material and knowledge concerning electrical applications, with a high level of service and product expertise.”

Contact us

Head office

Elpress AB

Industrivägen 15
P.O. Box 186
SE-872 24 Kramfors, Sweden
Tel +46 612 71 71 00
sales@elpress.se

Customer support

Tel +46 612 71 71 70
support@elpress.se

Order

Tel +46 612 71 71 70
order@elpress.se

Subsidiaries

Elpress GmbH

Kränkelsweg 24
DE-417 48 Viersen, Germany
Tel +49 2162 93 19-0
sales@elpress.de
www.elpress.de

Elpress A/S

Randersvej 16
DK-8600 Silkeborg, Denmark
Tel +45 8681 61 11
salg@elpress.dk
www.elpress.dk

Elpress AS

Bruket 31, Pb 79
N-1621 Gressvik, Norway
Tel +47 91 68 55 02
sales@elpress.no
www.elpress.no

Elpress Inc.,

900 Oakmont Lane, Suite 207,
Westmont IL 60559 USA
Tel: +1-331-814 2910
Fax: +1-331-814 2914
sales@elpress.us
www.elpress.us

Elpress (Beijing)

Electrical Components Co., Ltd
Rm 1605, Diyang Tower,
No. H2 DongsanhuanBei Lu,
Chaoyang District,
Beijing 100027, P.R. China
Tel:+86 10 5979 6187
Fax:+86 10 6438 5279
info@elpress.com.cn
www.elpress.com.cn

Elpress has been developing, manufacturing and marketing complete cable crimping systems for electrical connectors since 1959.

The Elpress Group, consisting of Elpress and ABIKO business areas, is owned by Lagercrantz Group AB. Elpress head office, factory and warehouse are located in Kramfors, Sweden.

Subsidiaries Elpress GmbH, Elpress A/S, Elpress AS, Elpress (Beijing) Ltd. and Elpress Inc. with local warehouses in Silkeborg/Denmark, Beijing/China and Chicago/USA.

The information contained in this catalogue is for commercial use to select products only. It is not intended for use in QA instructions, production drawings, instruction manuals or likewise. If such documentation is required, please contact your nearest Elpress representative or Elpress directly. Although every effort has been made to ensure correct and updated information at time of printing, Elpress makes reservation for misprints, wrong or outdated information and changes. Elpress reserve the right to change, update or discontinue products without prior notice.

This catalogue is the property of Elpress. Any reproduction in full, part or of pictures, is forbidden without prior written permission from Elpress AB.

Table of content

	Pre-insulated 0.1 - 6 mm ² terminals with associated tools	01
	End terminals 0.14 - 50 mm ² with associated tool	02
	Uninsulated terminals 0.15 - 10 mm ² with associated tools	03
	Cu terminals 0.75 - 1000 mm ²	04
	Al and AlCu terminals 16 - 1200 mm ²	05
	Tools for Cu, Al and AlCu terminals	06
	Overhead line connectors	07
	Shearbolt terminals for low and medium voltage	08
	Insulation kit for splicing	09
	Cutting and insulation stripping tools	10
	Deep earthing	11
	General information	12
	System Elpress	13

Certification and standards



IEC - International Electrical Commission
- issues international standards which, although not always compulsory, do have strong influence and are used as a basis within the international terminal trade.



DNV - Det Norske Veritas
Elpress KR/KS, KRF/KSF and KRT/KST terminals meet DNV's rules for classification of ships and Det Norske Veritas' Offshore Standards. The terminals are approved for installations on ships and mobile "offshore" units.



UL is an American standard which is also internationally accepted. KR/KS, KRF/KSF, KRFS, KRFN, KRT/KST UL approved in accordance with file no. E205350.

Environment policy

Elpress products and services, are designed to minimise environmental impact, to protect limited resources and to take the life-cycle perspective into consideration in connection with:

- Product development.
- Manufacturing.
- Use and withdrawal of products.

Each and every Elpress employee shall prioritize the personal responsibility for safety, quality and the environment within his daily work routine. Information and education will constitute normal activity for increased awareness.

Our suppliers and commissioned partners are chosen and influenced in such a way that they can comply with and add value to our Policy.

Our customers are informed about our environmental dedication and our partners have all the necessary knowledge to assist and advise all parties of the distribution chain and safeguard the proper use, stocking and final disposal of our products.

We continuously evaluate the results of our Policy and openly distribute information on our work and impact on the environment.

Our environment work has resulted in Elpress being certified to ISO 14001 since 2004. Our certificate, with number EMS 531083, is issued by the internationally recognized BSI, British Standards Institution, of England.

Quality

For us, quality means trying all the time to be the best in the business. That's why we are constantly developing our products, methods and ourselves, since knowledge is perhaps the most important component for achieving the highest quality. Our work on quality has resulted in Elpress being certified to ISO 9001 since 1992.

Our certificate, with number FM20987, is issued by the internationally recognized BSI, British Standards Institution, of England.

Verification of products

There are quite a lot of different test standards and approval routines that may be applied on cable connectors and terminations. Due to this and the variation in contents between standards from different countries one has to make a selection. Elpress had previously applied primarily Swedish, UK and German standards but lately IEC and EN Standards, where the latter rapidly will substitute the old national standards. In many cases, there are also UL, DNV-Det Norske Veritas or other approvals on our products.

Pre-insulated 0.1 - 6 mm² terminals with associated tools

General information about pre-insulated terminals	2
Hand tools for pre-insulated terminals	3
Ring terminals 0.1 - 6 mm ²	4
Fork terminals 0.1 - 6 mm ²	5
Flanged fork terminals 0.5 - 2.5 mm ²	5
Hook terminals 0.5 - 2.5 mm ²	6
Pin terminals 0.1 - 6 mm ²	6
Blade terminals 0.25 - 6 mm ²	7
Through connectors 0.25 - 6 mm ²	7
Through connectors with heat shrink insulation 0.5 - 6 mm ²	8
Parallel through connectors 0.5 - 6 mm ²	8
Receptacles rolled type 0.1 - 6 mm ²	9
Multiple tabs rolled type (piggy back) 0.5 - 2.5 mm ²	9
Receptacles fully insulated rolled type 0.5 - 6 mm ²	10
Blade 0.5 - 6 mm ²	10
End connector sleeves fully insulated 1 - 6 mm ²	11
Bullet 0.25 - 6 mm ²	11
End connector sleeves fully insulated 0.25 - 6 mm ²	11
Assortment boxes - pre-insulated terminals	12
RPL605, PL1001 and PL451M	12
PL450 and HB150	13
Hobby tools for pre-insulated and uninsulated 0.5 - 6 mm ² terminals	14
T50, T51 and T52 Hobby tool	14
Tools for pre-insulated 0.14 - 2.5 mm ² terminals	15
DSA0115, DSA0725 and ESAQ0760 - die nest gauge	15
Miniforce tools for pre-insulated	16
GSEA0340C and GSW0560C	16
GSA0760 and GSA0760C	17
Battery-powered crimping tools	18
PVL130P - Elpress Mini	18
PVL130S - Elpress Mini	19
Elpress Mobile - tool with interchangeable dies	20
Elpress Mobile, Mobile Installation & Mobile DataCom	20
Mobile Solar Kit and Mobile Box	21
Additional dies for Elpress Mobile	22

General information about pre-insulated terminals



System Elpress

System Elpress consists of terminals and tools that are designed and tested together to give a certified crimping result. This ensures that users will feel confident when using our systems, and that a secure connection will be achieved through the proper handling of our products.

Pre-insulated terminals

Elpress ring, fork and pin terminals are made of high-class copper 99.95%. The tab and bullet terminals are made of brass or tin-bronze. All terminals are then electrolytically tin-plated for maximum corrosion protection. The terminal's neck is brazed and annealed, which means it can be crimped in any direction. The metal in the receptacles' neck is double folded. This means that the finished terminal has excellent mechanical strength and low resistance.

Insulation material

Elpress insulation sleeves are usually made from halogen-free polycarbonate, PC, which has excellent deformation properties. Furthermore, it maintains its vibration support up to high temperatures. Caution must be exercised in case of alkaline exposure. Some types of terminals have insulation of PA, nylon, which is also halogen-free, or PVC (not halogen free). The colour of the insulation sleeve indicates the cross-sectional area that the terminal is intended for:

Bright yellow sleeve	0.1 - 0.5 mm ²
Green sleeve*	0.25 - 0.75 mm ²
Red sleeve	0.5 - 1.5 mm ²
Blue sleeve	1.5 - 2.5 mm ²
Yellow sleeve	4-6 mm ²

* or transparent white

The table below shows properties for Elpress pre-insulated terminals insulation. Note the properties are general since the influences of environment, temperature, etc. can affect the terminals. Polycarbonate, PC, and polyamide, PA, are halogen-free, i.e. they do not contain any of the substances fluoride, chlorine, bromide or iodine.

Insulation material	Max. temperature	Halogen-free	Flammability class, UL94
PA (Polyamide)	105°	Yes	V0
PC (Polycarbonate)	115°	Yes	V2
PVC (Polyvinyl chloride)	60°	No, chlorine	V0

Easy-entry

Elpress insulation sleeves are usually of the easy-entry type, which means it guides the conductor strands properly into the terminal neck. The risk of back-folded and stray strands, possibly resulting in flash-overs or reduced electrical properties, is therefore eliminated.

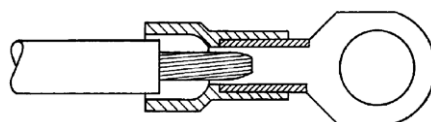

Easy-entry.

Labelling of pre-insulated terminals

Elpress pre-insulated terminals are labelled with logo, cross sectional area and any applicable screw diameter to facilitate work and controllability. When contact crimping pre-insulated terminals, Elpress crimping dies/tools leave an imprint in the insulation sleeve so that all crimped terminals can be inspected retrospectively in accordance with the requirements of many standards.



Samples of Elpress crimped pre-insulated terminals.

Designation example

Cat no. A1532R (E, FLS, G etc.)

A = pre-insulated
 15 = cross sectional area (1.5 mm²)
 32 = characteristic size (Hole 3.2 mm)
 E = end connectors
 FLS = receptacles, rolled type
 FLSF = receptacles, fully insulated rolled type
 FLSH = multiple tabs, rolled type (piggy back)
 FLST = receptacles, rolled type, tin-bronze
 G = fork terminals
 GB = flanged fork terminals
 H = tabs (male)
 HA = bullets (male)
 HO = sockets (female)
 K = hook terminals
 PSK = parallel connectors
 R = ring terminals
 SF = blade terminals
 SFB = blade terminals, flanged
 SFK = blade terminals, short pin
 SFL = blade terminals, long pin
 SFN = blade terminals, with tab
 SR = pin terminals
 SRK = pin terminals, short pin
 SK = through connectors
 SKW = through connectors with heat shrink insulation



Crimping of Elpress pre-insulated ring terminal with hand tool GSA0760.

Hand tools for pre-insulated terminals

Mechanical tools

In the development of a mechanical crimping tool at Elpress, we strive for the best quality and ergonomics in the actual tool, and the best characteristics in the crimped terminal. The tools have a built-in locking system (not the hobby tools) that ensures that the entire crimping process is completed - a prerequisite for professional and quality-assured work.



Elpress Mobile, professional tool with interchangeable dies for the installer or service technician.

Miniforce type C has longer handles to facilitate two-handed operation, which is often a simple and natural way to reduce the loads. Electrical crimping tools and terminals together constitute a contact crimping system where crimping results are continuously checked against the requirements of established standards such as IEC 60352-2, SEN 245010, DIN 46429, IEC 61238-1 etc. Many of the manual tools have symmetrical crimp positions that make it possible to work from both sides - something that is important for left-handed users. The tools in the Miniforce, D and 50 series are made of very high-grade hardened steel with a black oxide finish and are laser marked.



Certification of crimping tools

For quality assurance of our tools, we certify the manufacture of our crimping tools, both hand tools, type Gxx, i.e. Miniforce tools, and type Dxx.

Miniforce-tools

With the unique Miniforce tools, a new level has been established regarding ergonomic adaptation to the user and low force requirements. This has resulted in a decrease in the grip forces by up to 45% and is the result of an advanced development process where minimisation of the risks of work-related injuries and the best ergonomics have been the deciding factors.



What do we certify?

Certification of the crimping tools means that each individual tool is documented at the final assembly and inspection stage with respect to:

- **handle pre-load**, which is the force needed to ensure that the lock, which prevents a crimp from being interrupted, is not released too early.
- **crimp die nest heights**, i.e. the maximum height measurements which can be measured in each indentation with the dies pressed together.

Why certification?

The certificate that accompanies the tool serves several functions:

- crimping tools are often directly introduced upon procurement in a quality management system. The tool's status at procurement shall of course be the first thing noted, to then be followed by regular checks where potential changes can be discovered and addressed.
- the certificate shows that each individual tool meets the requirements of the tool's basic specifications.
- the certificate states what the most important characteristics are that shall be followed up.

Elpress' service department offers the possibility of continued follow-up of the quality of the tools.

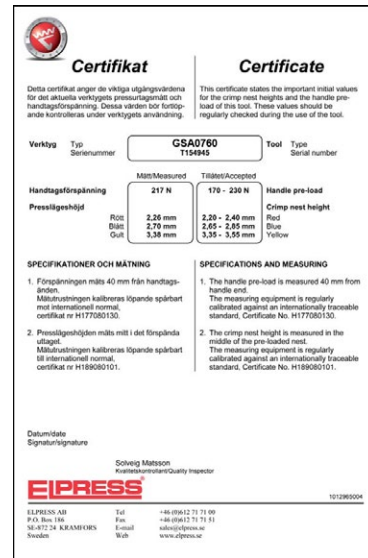

Certificate that accompanies the tool.



Get your certificate.



Elpress ergonomic Miniforce tool.



Ring terminals 0.1 - 6 mm²

- Material: Cu 99.95%, tin plated Cu/Sn, brazed neck.
- PC insulation has easy-entry, PC and PA are halogen-free.

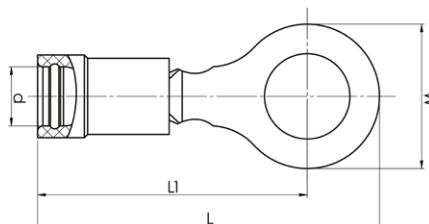

mm ² (Cu)	AWG Cu	Name	Screw	W mm	d	L	L1	t	s	Tool	Insulation material	Easy Entry	Pcs/pack
0,1-0,5	26-20	A0522R	M2,5	5,4	2	16	14	0,5	6	DSA0115	PA	No	100
0,1-0,5	26-20	A0532R	M3	5,4	2	16	14	0,5	6	DSA0115	PA	No	100
0,1-0,5	26-20	A0543R	M4	6,5	3	19	16	0,5	6	DSA0115	PA	Yes	100
0,1-0,5	26-20	A0553R	M5	8	2	19	16	0,5	6	DSA0115	PA	Yes	100
0,25-0,75	24-20	A0832R	M3	5,5	3,2	18	15	0,5	7	DSA0115	PC	Yes	100
0,25-0,75	24-20	A0837R	M3,5	6,2	3,2	21	17,5	0,5	7	DSA0115	PC	Yes	100
0,25-0,75	24-20	A0843R	M4	7,5	3,2	21	17,5	0,5	7	DSA0115	PC	Yes	100
0,25-0,75	24-20	A0853R	M5	9	3,2	22	17,5	0,5	7	DSA0115	PC	Yes	100
0,5-1,5	20-16	A1532R	M3	5,5	4	19	16	0,7	7	GSA0760	PC	Yes	100
0,5-1,5	20-16	A1537R	M3,5	6	4	19	16	0,7	7	GSA0760	PC	Yes	100
0,5-1,5	20-16	A1543R	M4	7	4	20,5	17	0,7	7	GSA0760	PC	Yes	100
0,5-1,5	20-16	A1553R	M5	9	4	22,5	18	0,7	7	GSA0760	PC	Yes	100
0,5-1,5	20-16	A1565R	M6	11	4	26,5	21	0,7	7	GSA0760	PC	Yes	100
0,5-1,5	20-16	A1585R	M8	14	4	27,5	20	0,7	7	GSA0760	PC	Yes	100
0,5-1,5	20-16	A1510R	M10	16,5	4	30,5	22	0,7	7	GSA0760	PC	Yes	100
1,5-2,5	15-14	A2532R	M3	5,5	4,5	19	16	0,8	8	GSA0760	PC	Yes	100
1,5-2,5	15-14	A2537R	M3,5	6,2	4,5	19	16	0,8	8	GSA0760	PC	Yes	100
1,5-2,5	15-14	A2543R	M4	7	4,5	21	17,5	0,8	8	GSA0760	PC	Yes	100
1,5-2,5	15-14	A2553R	M5	9	4,5	23	18	0,8	8	GSA0760	PC	Yes	100
1,5-2,5	15-14	A2565R	M6	11	4,5	26	20,5	0,8	8	GSA0760	PC	Yes	100
1,5-2,5	15-14	A2585R	M8	14	4,5	28	21	0,8	8	GSA0760	PC	Yes	100
1,5-2,5	15-14	A2510R	M10	16,5	4,5	30,5	22	0,75	8	GSA0760	PC	Yes	100
1,5-2,5	15-14	A2513R	M12	18	4,3	34	26	0,75	8	GSA0760	PA	Yes	100
4-6	12-10	A4643R	M4	7,8	6,4	24,5	20,5	1	9	GSA0760	PC	Yes	100
4-6	12-10	A4653R	M5	9	6,4	25	20,5	1	9	GSA0760	PC	Yes	100
4-6	12-10	A4665R	M6	11	6,4	28,5	23	1	9	GSA0760	PC	Yes	100
4-6	12-10	A4685R	M8	14	6,4	30,5	23,5	1	9	GSA0760	PC	Yes	100
4-6	12-10	A4610R	M10	17	6,4	34	25,5	1	9	GSA0760	PC	Yes	50
4-6	12-10	A4613R	M12	19,2	6,8	40	31	1	9	GSA0760	PC	Yes	50

t = palm thickness, s = strip length



Fork terminals 0.1 - 6 mm²

- Material: Cu 99.95%, tin plated Cu/Sn, brazed neck.
- PC insulation has easy-entry, PC and PA are halogen-free.

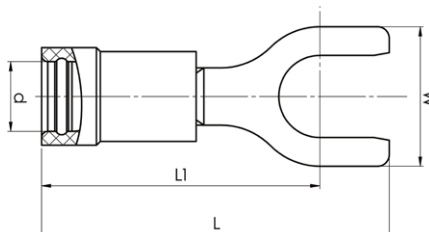

mm ² (Cu)	AWG Cu	Name	Screw	W mm	d	L	L1	t	s	Tool	Insulation material	Easy Entry	Pcs/pack
0,1-0,5	26-20	A0532G	M3	5,5	3,2	18	15	0,5	6	DSA0115	PA	No	100
0,25-0,75	24-20	A0832G	M3	5,5	3,2	18	15	0,5	7	DSA0115	PC	Yes	100
0,25-0,75	24-20	A0837G	M3,5	6,2	3,2	21	17,5	0,5	7	DSA0115	PC	Yes	100
0,25-0,75	24-20	A0843G	M4	6,2	3,2	21	17,5	0,5	7	DSA0115	PC	Yes	100
0,5-1,5	20-16	A1532G	M3	5,5	4	19	16	0,7	7	GSA0760	PC	Yes	100
0,5-1,5	20-16	A1537G	M3,5	6,2	4	21	17,5	0,7	7	GSA0760	PC	Yes	100
0,5-1,5	20-16	A1537GS	M3,5	5,5	4	21,2	17	0,7	7	GSA0760	PC	Yes	100
0,5-1,5	20-16	A1543G	M4	7	4	21	17,5	0,7	7	GSA0760	PC	Yes	100
0,5-1,5	20-16	A1553G	M5	9	4	22,5	18	0,7	7	GSA0760	PC	Yes	100
0,5-1,5	20-16	A1565G	M6	11	4	26,5	21	0,7	7	GSA0760	PC	Yes	100
1,5-2,5	16-14	A2532G	M3	5,5	4,5	18	15	0,8	8	GSA0760	PC	Yes	100
1,5-2,5	16-14	A2537G	M3,5	6,2	4,5	21	17,5	0,8	8	GSA0760	PC	Yes	100
1,5-2,5	16-14	A2537GS	M3,5	5,5	4,5	21,2	17	0,8	8	GSA0760	PC	Yes	100
1,5-2,5	16-14	A2543G	M4	7	4,5	21	17,5	0,8	8	GSA0760	PC	Yes	100
1,5-2,5	16-14	A2553G	M5	9	4,5	23	18	0,8	8	GSA0760	PC	Yes	100
1,5-2,5	16-14	A2565G	M6	11	4,5	25	19,5	0,8	8	GSA0760	PC	Yes	100
4-6	12-10	A4643G	M4	7,8	6,4	24	20	1	9	GSA0760	PC	Yes	100
4-6	12-10	A4653G	M5	9	6,4	25	20,5	1	9	GSA0760	PC	Yes	100
4-6	12-10	A4665G	M6	11	6,4	27	21,5	1	9	GSA0760	PC	Yes	100
4-6	12-10	A4685G	M8	14	6,4	30	23	1	9	GSA0760	PC	Yes	100
4-6	12-10	A4610G	M10	18	6,4	36	27,5	1	9	GSA0760	PA	Yes	100

t = palm thickness, s = strip length

Flanged fork terminals 0.5 - 2.5 mm²

- Material: Cu 99.95%, tin plated Cu/Sn, brazed neck.
- PC insulation has easy-entry, PC is halogen free.

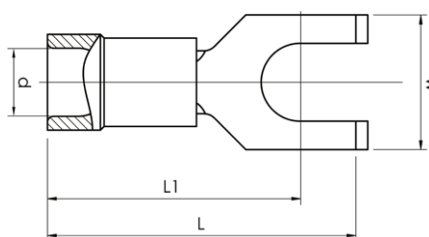

mm ² (Cu)	AWG Cu	Name	Screw	W mm	d	L	L1	t	s	Tool	Insulation material	Easy Entry	Pcs/pack
0,5-1,5	20-16	A1537GB	M3,5	6,2	4	21	17,5	0,7	7	GSA0760	PC	Yes	100
0,5-1,5	20-16	A1543GB	M4	6,2	4	21	17,5	0,7	7	GSA0760	PC	Yes	100
1,5-2,5	16-14	A2543GB	M4	6,2	4,5	21	17,5	0,8	7	GSA0760	PC	Yes	100
1,5-2,5	16-14	A2553GB	M5	9	4,5	22,5	17,5	0,8	7	GSA0760	PC	Yes	100

t = palm thickness, s = strip length



Hook terminals 0.5 - 2.5 mm²

- Material: Cu 99.95%, tin plated Cu/Sn, brazed neck.
- PC insulation has easy-entry, PC is halogen free.

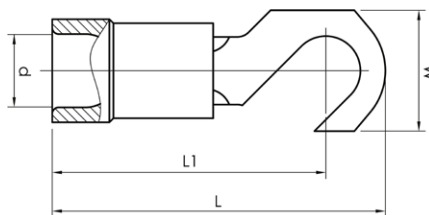

mm ² (Cu)	AWG Cu	Name	Screw	W mm	d	L	L1	t	s	Tool	Insulation material	Easy Entry	Pcs/pack
0,5-1,5	20-16	A1543K	M4	7	4	20,5	17	0,7	7	GSA0760	PC	Yes	100
1,5-2,5	16-14	A2543K	M4	7,5	4,5	21	17	0,8	8	GSA0760	PC	Yes	100

t = palm thickness, s = strip length

Pin terminals 0.1 - 6 mm²

- Material: Cu 99.95%, tin plated Cu/Sn, brazed neck.
- PC insulation has easy-entry, PC and PA are halogen-free.

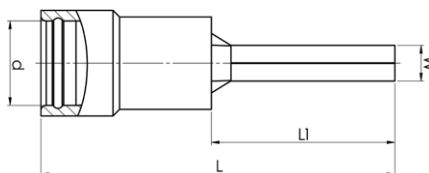

mm ² (Cu)	AWG Cu	Name	W mm	d	L	L1	s	Tool	Insulation material	Easy Entry	Pcs/pack
0,1-0,5	26-20	A0514SR	1,2	2,2	18	8	6	DSA0115	PA	No	100
0,25-0,75	24-20	A0819SR	1,8	3,2	22	12	7	DSA0115	PC	Yes	100
0,25-0,75	24-20	A0819SRK	1,8	3,2	18,5	8,5	7	DSA0115	PC	Yes	100
0,5-1,5	20-16	A1519SR	1,7	4	22	12	7	GSA0760	PC	Yes	100
0,5-1,5	20-16	A1519SRK	1,7	4	18,5	8,5	7	GSA0760	PC	Yes	100
1,5-2,5	16-14	A2519SR	1,9	4,5	21,5	11,5	8	GSA0760	PC	Yes	100
1,5-2,5	16-14	A2519SRK	1,9	4,5	18,5	8,5	8	GSA0760	PC	Yes	100
4-6	12-10	A4630SR	2,7	6,4	27	14	9	GSA0760	PC	Yes	100

s = strip length

Blade terminals 0.25 - 6 mm²

- Material: Cu 99.95%, tin plated Cu/Sn, brazed neck.
- PC insulation has easy-entry, PC is halogen free.

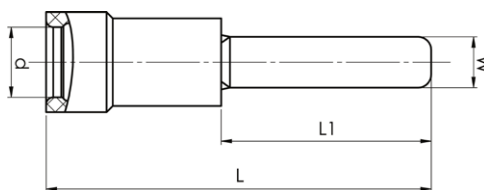

mm ² (Cu)	AWG Cu	Name	W mm	d	L	L1	t	s	Insulation material	Easy Entry	Tab	Tool	Pcs/pack
0,25-0,75	24-20	A08255FK	2,5	3,2	20	10	0,5	7	PC	Yes	No	DSA0115	100
0,5-1,5	20-16	A1518SFL	2,3	4,0	27,2	18	0,8	7	PVC	Yes	No	GSA0760	100
0,5-1,5	20-16	A1529SF	2,9	4	22	12	0,7	7	PC	Yes	No	GSA0760	100
0,5-1,5	20-16	A1529SFN	2,9	4	22	12	0,7	7	PC	Yes	Yes	GSA0760	100
0,5-1,5	20-16	A1530SFB	3	4	25,8	16,8	0,8	7	PVC	Yes	No	GSA0760	100
1,5-2,5	16-14	A2524SFL	2,3	4,5	27,2	18	0,8	8	PVC	Yes	No	GSA0760	100
1,5-2,5	16-14	A2529SF	2,9	4,3	21,5	11,5	0,8	8	PC	Yes	No	GSA0760	100
1,5-2,5	16-14	A2529SFN	2,9	4,3	22	12	0,8	8	PC	Yes	Yes	GSA0760	100
1,5-2,5	16-14	A2530SFB	3	4,5	25,8	16,8	0,7	8	PVC	Yes	No	GSA0760	100
4-6	12-10	A4640SF	4	6,8	27,5	13,5	1	9	PVC	Yes	No	GSA0760	100
4-6	12-10	A4645SFB	4,6	6,8	30,3	16,8	1	9	PVC	No	No	GSA0760	100

t = palm thickness, s = strip length

Through connectors 0.25 - 6 mm²

- Material: Cu 99.95%, tin plated Cu/Sn, contact sleeve of Cu pipe
- Halogen-free PC insulation without Easy-entry.

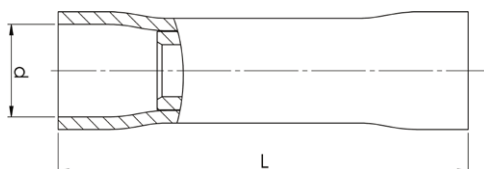

mm ² (Cu)	AWG Cu	Name	d mm	L	s	Tool	Insulation material	Easy Entry	Pcs/pack
0,25-0,75	24-20	A0824SK	2,9	24,5	7	DSA0115	PC	No	100
0,5-1,5	20-16	A1525SK	3,4	24	7	GSA0760	PC	No	100
1,5-2,5	16-14	A2527SK	4,3	26	8	GSA0760	PC	No	100
4-6	12-10	A4652SK	6,5	33	9	GSA0760	PC	No	50

s = strip length

Through connectors with heat shrink insulation 0.5 - 6 mm²

- Material: Cu 99.95%, tin plated Cu/Sn, contact sleeve of Cu pipe.
- Insulation of halogen-free PA, hot melt adhesive inside the insulation.

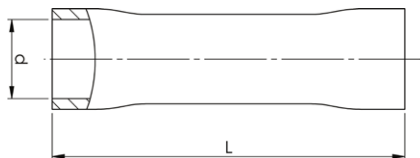

mm ² (Cu)	AWG Cu	Name	d mm	L	s	Tool	Insulation material	Pcs/pack
0,5-1,5	20-16	A1535SKW	3,7	31,5	8	GSW0560C	PA	25
1,5-2,5	16-14	A2535SKW	4,6	31,5	8	GSW0560C	PA	25
4-6	12-10	A4650SKW	6,5	37,5	9	GSW0560C	PA	25

s = strip length

After crimping and heating with a hot air gun, a water proof terminal, glued to the cable and the connector, is achieved.

Parallel through connectors 0.5 - 6 mm²

- Material: Cu 99.95%, tin plated Cu/Sn, contact sleeve of Cu pipe.
- Insulation of halogen-free PA.

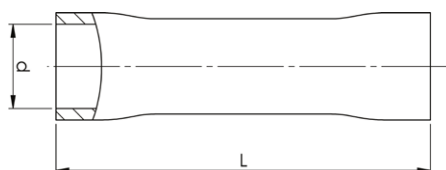

mm ² (Cu)	AWG Cu	Name	d mm	L	s	Tool	Insulation material	Pcs/pack
0,5-1,5	20-20	A1515PSK	3,2	17	7	GSA0760	PA	100
1,5-2,5	16-16	A2517PSK	4	17	8	GSA0760	PA	100
4-6	12-10	A4634PSK	5,6	21	9	GSA0760	PA	100

s = strip length

Type PSK must be crimped with GSA0760 (C) and with two crimps.



Receptacles rolled type 0.1 - 6 mm²

- Material: brass, tin plated Cu/Sn, brazed neck.
- PC and PA insulation have easy-entry, PC and PA are halogen-free.

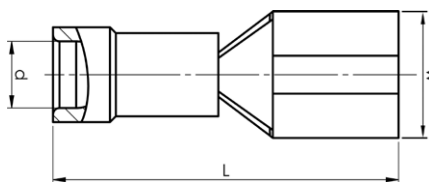

mm ² (Cu)	AWG Cu	Name	W mm	d	L	s	For tab	Tool	Insulation material	Neck type	Easy Entry	Pcs/pack	
0,1-0,5	26-20	A0503FLS5	3,7	2,2	16,4	7	2,8x0,5	DSA0115	PVC	Brazed	Yes	Brass, Cu/Sn	100
0,1-0,5	26-20	A0503FLS8	3,7	2,2	16,4	7	2,8x0,8	DSA0115	PVC	Brazed	Yes	Brass, Cu/Sn	100
0,5-1,5	20-16	A1503FLS5	3,2	4	18	7	2,8x0,5	GSA0760	PC	Brazed	Yes	Brass, Cu/Sn	100
0,5-1,5	20-16	A1503FLS8	3,2	4,0	18	7	2,8x0,8	GSA0760	PC	Brazed	Yes	Brass, Cu/Sn	100
0,5-1,5	20-16	A1505FLS5	5	3,2	19,5	7	4,8x0,5	GSA0760	PA	Brazed	Yes	Brass, Cu/Sn	100
0,5-1,5	20-16	A1505FLS8	5	3,2	19,5	7	4,8x0,8	GSA0760	PA	Brazed	Yes	Brass, Cu/Sn	100
0,5-1,5	20-16	A1507FLS	7,6	4	20,5	7	6,3x0,8	GSA0760	PC	Brazed	Yes	Brass, Cu/Sn	100
0,5-1,5	20-16	A1507FLST	7,6	4	20,5	7	6,3x0,8	GSA0760	PC	Brazed	Yes	Tin bronze (phosphor bronze), Cu/Sn	100
1,5-2,5	16-14	A2505FLS5	5,6	4,5	20	8	4,8x0,5	GSA0760	PA	Brazed	Yes	Brass, Cu/Sn	100
1,5-2,5	16-14	A2505FLS8	5	3,9	19,5	8	4,8x0,8	GSA0760	PA	Brazed	Yes	Brass, Cu/Sn	100
1,5-2,5	16-14	A2507FLS	7,6	4,5	20,5	8	6,3x0,8	GSA0760	PC	Brazed	Yes	Brass, Cu/Sn	100
1,5-2,5	16-14	A2507FLST	7,6	4,5	20,5	8	6,3x0,8	GSA0760	PC	Brazed	Yes	Tin bronze (phosphor bronze), Cu/Sn	100
4-6	12-10	A4607FLS	7,6	6,4	24	9	6,3x0,8	GSA0760	PC	Brazed	Yes	Brass, Cu/Sn	100
4-6	12-10	A4609FLS	10,9	6,6	30,1	9	9,5x1,2	GSA0760	PA	Reinforcement sleeve	Yes	Brass, Cu/Sn	100

s = strip length

Multiple tabs rolled type (piggy back) 0.5 - 2.5 mm²

- Material: brass/Cu, tin plated Cu/Sn.

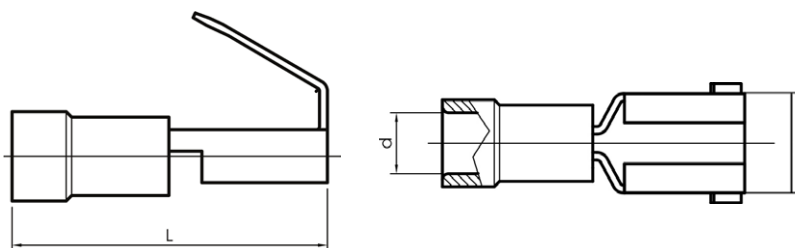

mm ² (Cu)	AWG Cu	Name	W mm	d	L	s	For tab	Insulation material	Neck type	Easy Entry	Pcs/pack
0,5-1,5	20-16	A1507FLSH	6,9	3,2	22	7	6,3x0,8	PA	Reinforcement sleeve	Yes	100
1,5-2,5	16-14	A2507FLSH	6,9	3,9	22	8	6,3x0,8	PA	Reinforcement sleeve	No	100

s = strip length

Receptacles fully insulated rolled type 0.5 - 6 mm²

- Material: brass, tin plated Cu/Sn, brazed neck.
- PC and PA insulation has easy-entry, PC and PA are halogen-free.

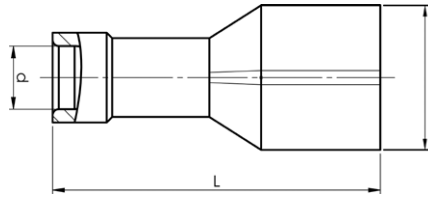

mm ² (Cu)	AWG Cu	Name	W mm	d	L	s	For tab	Insulation material	Neck type	Easy Entry	Pcs/pack
0,5-1,5	20-16	A1503FLSF5	5,5	3,4	19,5	7	2,8x0,5	PA	Reinforcement sleeve	Yes	100
		A1503FLSF8	5	3,4	19,5	7	2,8x0,8	PA	Reinforcement sleeve	Yes	100
		A1505FLSF5	7,2	4,1	19,5	7	4,8x0,5	PA	Reinforcement sleeve	Yes	100
		A1505FLSF8	7,2	4,1	19,5	7	4,8x0,8	PA	Reinforcement sleeve	Yes	100
		A1507FLSF	8,8	4	21,3	7	6,3x0,8	PC	Brazed	Yes	100
1,5-2,5	16-14	A2505FLSF5	7,2	4,5	19,5	8	4,8x0,5	PA	Reinforcement sleeve	Yes	100
		A2505FLSF8	7	3,9	19,5	8	4,8x0,8	PA	Reinforcement sleeve	Yes	100
		A2507FLSF	8,8	4,5	21,3	8	6,3x0,8	PC	Brazed	Yes	100
4-6	12-10	A4607FLSF	9,2	5,4	26	9	6,3x0,8	PA	Reinforcement sleeve	Yes	100

s = strip length

Blade 0.5 - 6 mm²

- Material: brass, tin plated Cu/Sn, brazed neck.
- PC and PA insulation have easy-entry, PC and PA are halogen-free.

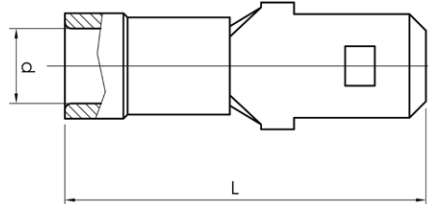

mm ² (Cu)	AWG Cu	Name	d mm	L	s	Tab	Insulation material	Neck type	Easy Entry	Pcs/pack
0,5-1,5	20-16	A1507H	4,1	22	7	6,3x0,8	PC	Brazed	Yes	100
1,5-2,5	16-14	A2507H	5	22,5	8	6,3x0,8	PC	Brazed	Yes	100
4-6	12-10	A4607H	6,6	24,5	9	6,3x0,8	PA	Reinforcement sleeve	No	100

s = strip length



End connector sleeves fully insulated 1 - 6 mm²

- Material: Cu, tin plated Cu/Sn.
- Insulation of halogen-free PA. Easy-entry.

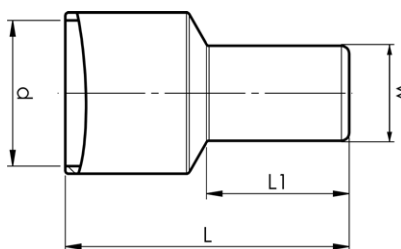

mm ² (Cu)	AWG Cu	Name	d mm	L	L1	s	Tool	Insulation material	Easy Entry	Pcs/pack
1-3	18-13	A2500E	6,4	15,2	8	8	GSA0760	PA	Yes	100
4-6	12-10	A4600E	9,2	17,7	9	9	GSA0760	PA	Yes	100

s = strip length

Bullet 0.25 - 6 mm²

- Material: brass/Cu, tin plated Cu/Sn.
- PC insulation has easy-entry, PC and PA are halogen-free.

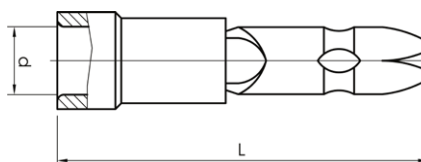

mm ² (Cu)	AWG Cu	Name	d mm	L	s	Bullet	Tool	Insulation material	Neck type	Easy Entry	Pcs/pack
0,25-0,75	24-20	A0802HA	3,1	26	7	2,0	DSA0115	PA	Reinforcement sleeve	No	100
0,5-1,5	20-16	A1504HA	4	22	7	4,0	GSA0760	PC	Brazed	Yes	100
1,5-2,5	16-14	A2505HA	4,3	20,7	8	5,0	GSA0760	PVC	Reinforcement sleeve	No	100
4-6	12-10	A4605HA	6,6	25,7	9	5,0	GSA0760	PA	Reinforcement sleeve	No	100

s = strip length

End connector sleeves fully insulated 0.25 - 6 mm²

- Material: brass/Cu, tin plated Cu/Sn.
- PC insulation has easy-entry, PC and PA are halogen-free.

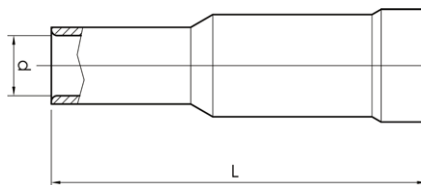

mm ² (Cu)	AWG Cu	Name	d mm	L	s	For bullets	Tool	Insulation material	Neck type	Easy Entry	Material	Pcs/pack
0,25-0,75	24-20	A0802HO	3,1	24,5	7	2	DSA0115	PA	Reinforcement sleeve	No	Brass/Cu, Cu/Sn	100
0,5-1,5	20-16	A1504HO	4	25	7	4	GSA0760	PC	Brazed	Yes	Tin bronze (phosphor bronze), Cu/Sn	100
1,5-2,5	16-14	A2505HO	3,2	25	8	5	GSA0760	PVC	Reinforcement sleeve	No	Brass/Cu, Cu/Sn	100
4-6	12-10	A4605HO	5,7	27	9	5	GSA0760	PA	Reinforcement sleeve	No	Brass/Cu, Cu/Sn	100

s = strip length



Assortment boxes - pre-insulated terminals



CE RPL605



RPL605 is a complete assortment box for professional work, containing terminals and tools.

Properties:

- certified crimping tool GSA0760, crimp area 0.5-6 mm²
- stripping tool SCT001, cuts and strips 0.5-6 mm²
- 605 x Elpress pre-insulated 0.5-6 mm² terminals

mm ²	AWG	Name	Net weight (kg)	Length mm	Width	Height
0,5-6	20-10	RPL605	2,05	261	338	57



CE PL1001



Elpress assortment box designed for electromechanical and service workshops.

Properties:

- box made of ABS plastic, inserts made of polystyrene
- 29 compartments
- 997 pre-insulated 0.5-6 mm² terminals
- 4 connection blocks
- crimping tool GSA0760 Miniforce
- stripping tool SCT001

mm ²	AWG	Name	Net weight (kg)	Length mm	Width	Height
0,5-6	20-10	PL1001	2,94	380	285	55



CE PL451M



Elpress assortment box for professional use.

Properties:

- box made of polypropylene, insert made of polystyrene
- 11 compartments
- 346 pre-insulated 0.5-6 mm² terminals
- 3 connection blocks
- crimping tool GSA0760 Miniforce
- stripping tool SCT001

mm ²	AWG	Name	Net weight (kg)	Length mm	Width	Height
0,5-6	20-10	PL451M	1,275	245,5	215	56,5





PL450

Elpress assortment box designed for hobby use.

Properties:

- box made of polypropylene, insert made of polystyrene
- 11 compartments
- 346 pre-insulated 0.5-6 mm² terminals
- 3 connection blocks
- crimping tool hobby T50, which contact crimps, cuts and strips up to and including 6 mm² and cuts M2.5-M5 screws



mm ²	AWG	Name	Net weight (kg)	Length mm	Width	Height
0,5-6	20-10	PL450	1,019	245,5	215	56,5



HB150

Elpress assortment box designed for hobby use.

Properties:

- box made of polypropylene, insert made of polystyrene
- 11 compartments
- 147 pre-insulated 0.5 - 6 mm² terminals
- 2 connection blocks
- crimping tool hobby T50, which contact crimps, cuts and strips up to and including 6 mm² and cuts M2.5-M5 screws



mm ²	AWG	Name	Net weight (kg)	Length mm	Width	Height
0,5-6	20-10	HB150	0,781	245,5	215	56,5



Hobby tools for pre-insulated and uninsulated 0.5 - 6 mm² terminals as well as cutting and stripping

Properties:

- made of high-grade steel with semi-soft handles
- crimping positions are clearly marked
- the tools do not have a locking function
- cuts up to and including 6 mm²
- strips up to and including 6 mm²
- cuts screws M2.5-M5



T50 Hobby tool



Special properties:

- contact crimps pre-insulated 0.5 - 6 mm² terminals and tab crimps uninsulated 1.5 - 6 mm² terminals
- red handle

Crimp geometries

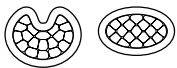

mm ²	AWG	Name	Crimp geometries	Net weight (kg)	Length mm
0,5-6	20-10	T50	Tab, Oval	0,268	225



T51 Hobby tool



Special properties:

- contact crimps pre-insulated 0.5 - 6 mm² terminals and roll crimps uninsulated 0.5 - 2.5 mm² terminals
- yellow handle

Crimp geometries



mm ²	AWG	Name	Crimp geometries	Net weight (kg)	Length mm
0,5-6	20-10	T51	Oval, Roll	0,268	225



T52 Hobby tool



Special properties:

- roll crimps uninsulated 0.5 - 6 mm² terminals
- green handle

Crimp geometry



mm ²	AWG	Name	Crimp geometry	Net weight (kg)	Length mm
0,5-6	20-10	T52	Roll	0,268	225



Tools for pre-insulated 0.14 - 2.5 mm² terminals with measuring certificates



- Properties:**
- crimping positions are clearly marked
 - adjustable for changes after long use
 - tested with Elpress terminals
 - locking function that ensures a complete crimp
 - emergency release if the crimping process has to be interrupted
 - unique design that makes the tools thin and versatile
 - minimal muscle strength required for complete crimp
 - suitable for both right and left-handed users
 - withstands at least 50,000 crimps
- supplied with certificate for basic quality monitoring



DSA0115



Tested and certified mechanical hand tool for symmetrical crimping of pre-insulated terminals 0.14-1.5 mm².

- Special properties:**
- easy to check red die nests easily with die nest gauge, ESAQ0760

Crimp geometry



mm ²	AWG	Name	Crimp geometry	Net weight (kg)	Length mm	Width
0,14-1,5	26-16	DSA0115	Oval	0,445	192	66



DSA0725



Tested and certified mechanical hand tool for symmetrical crimping of pre-insulated terminals 0.5-2.5 mm².

- Special properties:**
- die nests are easily checked with die nest gauge, ESAQ0760

Crimp geometry



mm ²	AWG	Name	Crimp geometry	Net weight (kg)	Length mm	Width
0,5-2,5	20-14	DSA0725	Oval	0,449	192	66

ESAQ0760 - die nest gauge

Go/no-go gauge for inspection of die nests in the following tools: DSA0115, DSA0725, GSA0760(C), GSEA0340C.

- Special properties:**
- handle part Ø 8 mm
 - easy to check tool die nest
 - The go and no go dimensions are checked in the die nests upon calibration.
- Contact Elpress for more information on calibration and quality management



mm ²	AWG	Name	Net weight (kg)	Shaft ø	Length mm
0,5-2,5	20-14	ESAQ0760	0,024	8	55

Tool	Die nests
DSA0115	
DSA0725	
GSA0760(C)	
GSEA0340(C)	

Miniforce tools for pre-insulated 0.5 - 6 mm² terminals and 0.25 - 4 mm² end casings with measuring certificates



Properties:

- locking function which only releases once crimping is complete
- emergency release if the crimping process has to be interrupted
- symmetrical and clearly marked crimping positions
- adjustable for changes after long use
- tested with Elpress terminals
- unique mechanism that reduces maximum handle force from 450 N right down to 250 N (model C)
- ergonomic handle suitable for all users
- maximises the quality of work
- reduces the risk of occupational injuries
- light and versatile design without sacrificing on strength
- model C has extra long handles for the use of two hands
- withstands at least 80,000 crimps
- supplied with certificate for basic quality monitoring



GSEA0340C



Tested and certified mechanical Miniforce hand tool for crimping pre-insulated terminals 0.5-2.5 mm² as well as pre-insulated and uninsulated end sleeves 0.25-4 mm².

mm ²	AWG	Name	Crimp geometries	Net weight (kg)	Length mm	Width
0,5-2,5 / 0,25-4	20-14 / 22-12	GSEA0340C	Oval, Trapezoid	0,613	256	80

Crimp geometries



GSW0560C



Tested and certified mechanical Miniforce hand tool for crimping 0.5-6 mm² through connectors with heat shrink insulation of the SKW type.

mm ²	AWG	Name	Crimp geometry	Net weight (kg)	Length mm	Width
0,5-6	20-10	GSW0560C	Oval	0,612	256	80

Crimp geometry





GSA0760 and GSA0760C

Tested and certified mechanical Miniforce hand tools for symmetrical crimping of pre-insulated terminals 0.5-6 mm².

Special properties:

- locator that holds the terminal in the right position when crimping and facilitates work in, for example, tight spaces
- die nests are easily checked with die nest gauge, ESAQ0760



mm ²	AWG	Name	Crimp geometry	Net weight (kg)	Length	Width
0,5-6	20-10	GSA0760	Oval	0,548	203	76
0,5-6	20-10	GSA0760C	Oval	0,607	256	80

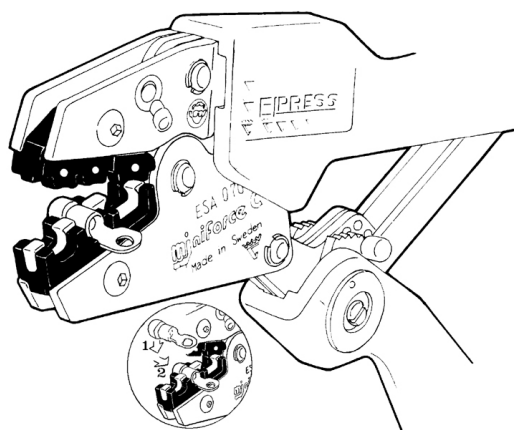

Follow procedures (1) and (2) when attaching the terminal in the locator on tool GSA0760(C).

Crimp geometry



Battery-powered crimping tools for pre-insulated 0.5 - 6 mm² terminals, uninsulated 0.25 - 10 mm² terminals and 0.5 - 50 mm² end sleeves

Properties:

- Li-ion battery powered (10.8 V and 2 Ah), charging time about 40 min
- very good accessibility and ergonomics
- service and installation tools
- fast crimping process 2 – 4 sec
- approximately 230 crimps/battery charge
- dies for the tool sold separately



PVL130P - Elpress Mini

Elpress mini tool with a sleek design with a high performance Li-Ion battery that facilitates your work with its improved battery capacity. Crimping force max. 13 kN. 1 x Li-ion battery and charger included.

Properties:

- one-handed operation for easy control of all tool functions
- durable crimping head for long service life
- optimal crimping thanks to parallel-moving dies
- easy to use due to its low weight
- high-performance 12 V Li-Ion battery – with indication of charge status
- open head, rotating
- easy and comfortable to use one handed thanks to its ergonomic 2-component housing with grip-friendly protection
- automatic return of dies when crimping is complete



PVL130P - Elpress MINI, dies sold separately.

mm ² (Cu)	AWG (Cu)	Name	Net weight (kg)	Length mm	Width	Height	Note
0,25-50	24-1/0	PVL130P	1,5	330	85	60	Charger: 230VAC
0,25-50	24-1/0	PVL130P-US	1,5	330	85	60	Charger: 115VAC
0,25-50	24-1/0	PVL130P-WOBC	0,91	330	85	60	without Battery/ Charger



PVL130P, case and charger.





PVL130S - Elpress Mini



PVL130S - Elpress MINI, supplied with die pair SA0760.

Elpress mini tools with intuitive PowerSense function combine the benefits of manual crimping tools with the benefits of battery-powered hydraulic crimping tools.

Crimping force max. 15 kN. 1 x Li-ion battery and charger included.

Properties:

- one-handed operation for easy control of all tool functions
- electronic control with locking function and monitoring for complete closure of the jaws
- safety loop used as fall protection when used outdoors
- motor protection ensures safety in case of overload
- easy and comfortable to use one handed thanks to its ergonomic 2-component housing with grip-friendly protection
- very low weight and fast crimping process for maximum efficiency
- powerful driving technology allows for easy crimps
- high-performance 12 V Li-Ion battery – with indication of charge status
- LED work lighting
- Die pair SA0760 comes with the tool

mm ² (Cu)	AWG (Cu)	Name	Net weight (kg)	Length mm	Width	Height	Note
0,25-50	24-1/0	PVL130S	1,5	58	92	250	Charger: 230VAC
0,25-50	24-1/0	PVL130S-US	0,96	58	92	250	Charger: 115VAC
0,25-50	24-1/0	PVL130S-WOBC	0,91	58	92	250	without Battery/Charger



Dies for PVL130P/PVL130S



EB0560



WB4099



KB0325



EB3550



EB1025



EB4010



RB0560



SA0760

mm ² (Cu)	AWG (Cu)	Name	Crimp geometry	Net weight (kg)	Application
0,5-6	20-10	SA0760	Oval	0,05	Pre-insulated terminals
0,25-2,5	22-14	KB0325	Tab	0,039	Uninsulated terminals
4-10	12-8	WB4099	W	0,05	Uninsulated terminals
0,5-6	20-10	RB0560	Roll	0,05	Uninsulated terminals
0,5-6	20-10	EB0560	Trapezoid	0,057	End sleeves
4-10	12-8	EB4010	Trapezoid	0,05	End sleeves
10-25	6-4	EB1025	Trapezoid	0,05	End sleeves
35-50	2-0	EB3550	Trapezoid	0,05	End sleeves

Elpress Mobile - tool with interchangeable dies



Professional contact crimping tool with interchangeable dies for the installer or service technician.

Properties:

- reliable, safe, economic and ergonomic tools
- parallel-moving crimping movement with 10 kN crimping force, tested for 20,000 crimps
- change crimping dies quickly and easily in one operation
- the crimping dies are kept together in pairs and stored in custom holders
- wide selection of dies allows you to use one tool frame for 19 different crimping applications!



Elpress Mobile, frame only.

Elpress Mobile

Mobile hand tool (frame only). Dies are supplementary.

mm ²	AWG	Name	Net weight (kg)	Length mm	Width
0,25-10	24-8	MOBILE	0,554	234	64



Elpress Mobile + dies OAA0525 and OEB0210.

Mobile Installation

Mobile hand tool with two interchangeable dies:

- Die OAA0525 for crimping pre-insulated 0.5 - 2.5 mm² terminals.
- Die OEB0210 for crimping end sleeves 0.25 - 10 mm².
- The tool comes with associated dies in blister packaging.

Name	Net weight (kg)	Length mm	Width
MOBILE INSTALLATION	0,695	234	64



Elpress Mobile + dies OMP45 and OCC1113.

Mobile DataCom

Mobile hand tool with two interchangeable dies:

- OMP45 for crimping modular plug RJ45.
- OCC1113 for crimping coaxial contacts RG58, RG59, RG62 and RG71.
- The tool comes with associated dies in blister packaging.

Name	Net weight (kg)	Length mm	Width
MOBILE DATA/COM	0,667	234	64





Elpress Mobile + dies OMS4, OMS3 and OMSL.



Cable stripper LOKE.

Mobile Solar Kit

Mobile hand tool with three interchangeable dies and cable stripper LOKE for stripping solar panel cable with extra thick insulation:

- OMS4, roll crimping of contacts with sleeve \varnothing 4 mm, 2.5 - 6.0 mm².
- OMS3, square crimping of contacts with sleeve \varnothing 3 mm, 2.5 - 6.0 mm².
- OMSL, square crimping of contacts, 2.5 - 6.0 mm².

Name	Net weight (kg)	Length mm	Width
MOBILE SOLAR	0,772	234	64



Mobile Box

Box for the mobile tool with room for the tool as well as 5-6 associated dies. Tools and dies are ordered separately.

Name	Net weight (kg)	Length mm	Width	Height
MOBILE BOX	0,32	246	218	57

Additional dies for Elpress Mobile

All dies have the same quick and easy way of being inserted into the tool frame. The dies are kept together in pairs and supplied in a cassette that can be docked to other cassettes.



OAA0160
Crimping die for Elpress MOBILE tool for asymmetric crimping of pre-insulated terminals 0.1-4 mm² and 4-6 mm².
AWG 11-9



OAA0525
Crimping die for Elpress MOBILE tool for asymmetric crimping of pre-insulated terminals 0.5-2.5 mm².
AWG 20-13.



OSW0360
Crimping die for Elpress MOBILE tool for crimping through connectors with heat shrink insulation 0.3-0.75 mm² and 4-6 mm².
AWG 11-9.



OSW0525
Crimping die for Elpress MOBILE tool for crimping through connectors with heat shrink insulation 0.5-1.5 mm² and 1.5-2.5 mm².
AWG 15-13.



OPB0140
Crimping die for Elpress MOBILE tool for crimping global power connectors, GPC connectors.



OPB6099
Crimping die for Elpress MOBILE tool for crimping global power connectors, GPC connectors.

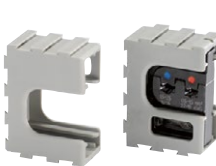

OWB4099
Crimping die for Elpress MOBILE tool for W crimping of uninsulated terminals 4-10 mm².
AWG 11-7.



OKB0725
Crimping die for Elpress MOBILE tool for punch crimping uninsulated terminals 0.75-2.5 mm².
AWG 18-13.



OKB0560
Crimping die for Elpress MOBILE tool for punch crimping uninsulated terminals 0.5-6 mm².
AWG 20-9.



OEB0210
Crimping die for Elpress MOBILE tool for crimping end sleeves 0.25-10 mm².
AWG 24-7.



OEB1625
Crimping die for Elpress MOBILE tool for crimping end sleeves 16-25 mm².
AWG 5-3.



OEB3550
Crimping die for Elpress MOBILE tool for crimping end sleeves 35-50 mm².
AWG 2-1/0.



ORB0110
Crimping die for Elpress MOBILE tool for roll crimping uninsulated terminals 0.1-1 mm².
AWG 26-17.



ORB0560
Crimping die for Elpress MOBILE tool for roll crimping uninsulated terminals 0.5-6 mm².
AWG 20-9.



OMP45
Crimping die for Elpress MOBILE tool for crimping modular plug RJ45.



OMP11
Crimping die for Elpress MOBILE tool for crimping modular plug RJ11.



OFO5432
Crimping die for Elpress MOBILE tool for crimping fibre optic contacts.



OCC0908
Crimping die for Elpress MOBILE tool for crimping coaxial contacts RG174, 179.



OCC1113
Crimping die for Elpress MOBILE tool for crimping coaxial contacts RG58, 59, 62, 71.



OCC4755
Crimping die for Elpress MOBILE tool for crimping coaxial contacts RG6, 59.



OMS4
Dies for Mobile tools for roll crimping contacts with sleeve diameter 4 mm, 2.5-6.0 mm².
AWG 13-19.



OMSL
Die for square crimping contacts 2.5-6.0 mm².
AWG 13-9.



End terminals 0.14 - 50 mm² with associated tool

General information about end terminals	2
Hand tools for end terminals	3
Pre-insulated end terminals 0.14 - 50 mm ² ET standard colour.....	4
Pre-insulated end terminals 0.14 - 50 mm ² ETT alternative colour.....	5
Pre-insulated end terminals 0.14 - 50 mm ² ETD alternative colour.....	6
Uninsulated end terminals 0.25 - 50 mm ²	7
Pre-insulated TWIN-end terminals 2 x 0.5 - 2 x 10 mm ² ET2 standard colour code.....	8
Pre-insulated TWIN-end terminals 2 x 0.5 - 2 x 10 mm ² ETT2 alternative colour code.....	9
Pre-insulated TWIN-end terminals 2 x 0.5 - 2 x 10 mm ² ETW2 alternative colour code.....	10
Assortment boxes - end terminals.....	11
PL800ET with tools.....	11
RPL5548, SD4016 & SD0525.....	12
Miniforce tool for end terminals 0.14 - 16 mm ²	13
PEB0116S, PEB0116H, PEB0110T and PEB0110T18	13
Miniforce-tool for end terminals 0.25 - 4 mm ²	14
GSEA0340C	14
Miniforce tool for end terminals 0.1 - 6 mm ² and TWIN end terminals 2 x 0.5 - 2 x 10 mm ²	15
GEB4010C-TWIN and PZD3	15
Miniforce tool for end terminals 4 - 50 mm ²	16
GEB4010C, GEB1025 and GEB1025C.....	16
GEB3550 and GEB3550C.....	17
Battery-powered crimping tools	18
PVL130P - Elpress Mini.....	18
PVL130S - Elpress Mini.....	19
Elpress Mobile - tool with interchangeable dies.....	20
Elpress Mobile, Mobile Installation and Mobile DataCom.....	20
Mobile Box	21
Additional dies for Elpress Mobile	22

General information about end terminals



With Elpress end terminals you avoid splayed conductors and reduce the risk of cable breaks. Moreover, they create a lasting contact pressure and a large contact area.

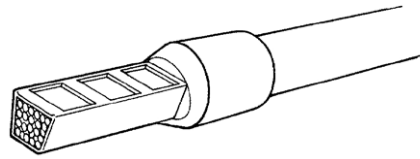

Crimped End terminal.

Designation example

Cat. no. A4-12ET

A = pre-insulated
 B = uninsulated
 4 = area (4 mm²)
 12 = Length metal sleeve
 ET = end terminal
 ET2 = TWIN end terminal



CSA certification

CSA, Canadian Standards Association, is a Canadian organisation that certifies products according to US standards. Elpress end sleeves of type A..ET / ETT / ETD, B. .. ET, A...ET2/ETT2/ETW2 is CSA certified according to US standard C22.2 No 158 and UL 1059 according to file No. 247206. End terminals of the type A..ET/B...ET/A...ET2 are intended for stranded Cu-conductors 26 AWG to 500 MCM, equivalent to the metric sizes 0.14 mm² to 240 mm². To be used together with Elpress crimping tool.

System Elpress

System Elpress consists of terminals and tools that are adapted and tested together for best performance. This ensures that users will feel confident when using our systems, and that a secure terminal is achieved through the proper handling of our products. Using an Elpress crimping tool when crimping an Elpress end terminal means that a terminal is obtained according to DIN 57609.

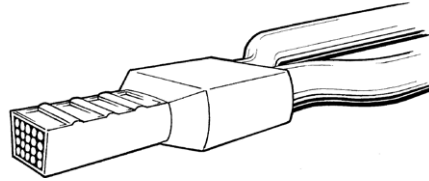

Crimped TWIN end terminal.

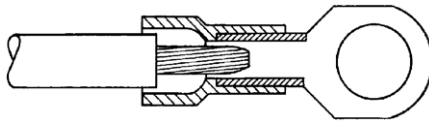

Easy-entry.

End sleeves

Elpress pre-insulated and uninsulated end terminals are made of 99.95% copper and are tin plated. The end terminals have dimensions according to DIN 46228 with a few exceptions (see note in tables). The insulation boot is made of PP (polypropylene) and has a shape comparable to easy-entry, see image. Elpress end terminals are used when you need a perfect connection for the cable end.

Colour codes for pre-insulated end terminals and TWIN-end terminals

AWG	Area mm ²	Standard colour W Elpress type ET	Colours acc. to DIN 46228 Elpress type ETD	Alternative colour T type ETT
26	0,14	grey	grey	brown
24	0,25	light blue	yellow	violet
22	0,34	turquoise	turquoise	pink
20	0,50	orange	white	white
18	0,75	white	grey	blue
17	1	yellow	red	red
15	1,5	red	black	black
13	2,5	blue	blue	grey
11	4	grey	grey	orange
9	6	black	yellow	green
7	10	ivory	red	brown
5	16	green	blue	white
3	25	brown	yellow	black
2	35	beige	red	red
1/0	50	olive-green	blue	blue
2/0	70	yellow	yellow	yellow
3/0	95	red	red	red
250	120	blue	blue	blue
300	150	yellow	yellow	yellow

Hand tools for end terminals

Mechanical tools

In the development of a mechanical crimping tool at Elpress, we strive for the best quality and ergonomics in the actual tool, and the best characteristics in the crimped terminal. The tools have a built-in locking system (not the hobby tools) that ensures that the entire crimping process is completed - a prerequisite for professional and quality-assured work.



Elpress Mobile, professional tool with interchangeable dies for the installer or service technician.

Miniforce-tools

With the unique Miniforce tools, a new level has been established regarding ergonomic adaptation to the user and low force requirements. This has resulted in a decrease in the grip forces by up to 45% and is the result of an advanced development process where minimisation of the risks of work-related injuries and the best ergonomics have been the deciding factors.



Miniforce type C has longer handles to facilitate two-handed operation, which is often a simple and natural way to reduce the loads. Electrical crimping tools and terminals together constitute a contact crimping system where crimping results are continuously checked against the requirements of established standards such as IEC 60352-2, SEN 245010, DIN 46429, IEC 61238-1 etc. Many of the manual tools have symmetrical crimp positions that make it possible to work from both sides - something that is important for left-handed users. The tools in the Miniforce, D and 50 series are made of very high-grade hardened steel with a black oxide finish and are laser marked.



Certification of crimping tools

For quality assurance of our tools, we already certify the manufacture of our crimping tools, both hand tools, type Gxx, i.e. Miniforce tools, and type Dxx.



What do we certify?

Certification of the crimping tools means that each individual tool is documented at the final assembly and inspection stage with respect to:

- **handle pre-load**, which is the force needed to ensure that the lock, which prevents a crimp from being interrupted, is not released too early.
- **crimp die nest heights**, i.e. the maximum height measurements which can be measured in each indentation with the dies pressed together.

Why certification?

The certificate that accompanies the tool serves several functions:

- crimping tools are often directly introduced upon procurement in a quality management system. The tool's status at procurement shall of course be the first thing noted, to then be followed by regular checks where potential changes can be discovered and addressed.
- the certificate shows that each individual tool meets the requirements of the tool's basic specifications.
- the certificate states what the most important characteristics are that shall be followed up.

Elpress' service department offers the possibility of continued follow-up of the quality of the tools.

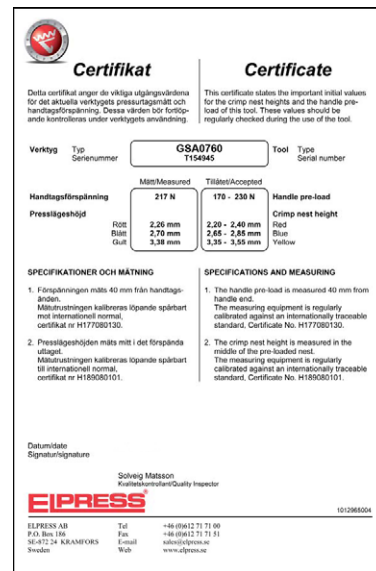

Certificate that accompanies the tool.



Get your certificate.



Elpress ergonomic Miniforce tool.

Pre-insulated end terminals 0.14 - 50 mm² ET standard colour



- Material: Cu 99.95%, tin plated Cu/Sn, CSA approved.
- Polypropylene insulation, colour code W.



mm ² (Cu)	AWG Cu	Name	d mm	L	L1	s	Measures acc DIN46228	Tool	Pcs/pack
0,14	26	A0,14-6ET	1,9	10	6	8	Yes	PEB0110T	500
0,14	26	A0,14-8ET	1,9	12	8	10	No	PEB0110T	500
0,25	24	A0,25-6ET	1,9	10	6	8	No	PEB0110T	100
0,25	24	A0,25-8ET	1,9	12	8	10	No	PEB0110T	500
0,34	22	A0,34-6ET	1,9	10	6	8	No	PEB0110T	100
0,34	22	A0,34-8ET	1,9	12	8	10	No	PEB0110T	100
0,5	20	A0,5-6ET	2,4	12	6	8	Yes	PEB0110T	100
0,5	20	A0,5-8ET	2,4	14	8	10	Yes	PEB0110T	100
0,5	20	A0,5-10ET	2,4	156	10	12	Yes	PEB0110T	100
0,75	20	A0,75-6ET	2,8	12	6	8	Yes	PEB0110T	100
0,75	20	A0,75-8ET	2,8	14	8	10	Yes	PEB0110T	100
0,75	20	A0,75-10ET	2,8	16	10	12	Yes	PEB0110T	100
0,75	20	A0,75-12ET	2,8	18	12	14	Yes	PEB0110T	100
1	18	A1-6ET	3	12	6	8	Yes	PEB0110T	100
1	18	A1-8ET	3	14	8	10	Yes	PEB0110T	100
1	18	A1-10ET	3	16	10	12	Yes	PEB0110T	100
1	18	A1-12ET	3	18	12	14	Yes	PEB0110T	100
1,5	16	A1,5-6ET	3,3	12	6	8	No	PEB0110T	500
1,5	16	A1,5-8ET	3,3	14	8	10	Yes	PEB0110T	100
1,5	16	A1,5-10ET	3,3	16	10	12	Yes	PEB0110T	100
1,5	16	A1,5-12ET	3,3	18	12	14	Yes	PEB0110T	500
1,5	16	A1,5-18ET	3,3	24	18	20	Yes	PEB0110T18	100
2,08	14	A2,08-8ET	3,5	14	8	10	No	PEB0110T	500
2,5	14	A2,5-8ET	4,2	15	8	10	Yes	PEB0110T	100
2,5	14	A2,5-10ET	4,1	17	10	12	Yes	PEB0110T	500
2,5	14	A2,5-12ET	4,2	19	12	14	Yes	PEB0110T	100
2,5	14	A2,5-18ET	4,2	25	18	20	Yes	PEB0110T18	100
4	12	A4-10ET	4,8	17	10	12	Yes	PEB0110T	100
4	12	A4-12ET	4,8	20	12	14	Yes	PEB0110T	100
4	12	A4-18ET	4,8	26	18	20	Yes	PEB0110T18	100
6	10	A6-12ET	6,1	20	12	14	Yes	PEB0110T	100
6	10	A6-18ET	6,1	26	18	20	Yes	PEB0110T18	100
10	8	A10-12ET	7,4	21	12	14	Yes	GEB1025	100
10	8	A10-18ET	7,4	27	18	20	Yes	GEB1025	100
16	6	A16-12ET	8,8	23	12	14	Yes	GEB1025	100
16	6	A16-18ET	8,8	29	18	20	Yes	GEB1025	100
25	4	A25-16ET	10,9	29	16	18	Yes	GEB1025	50
25	4	A25-18ET	10,9	31	18	20	Yes	GEB1025	50
25	4	A25-22ET	10,9	35	22	24	Yes	GEB1025	50
35	2	A35-16ET	12,3	30	16	18	Yes	GEB3550	50
35	2	A35-18ET	12,3	32	18	20	Yes	GEB3550	50
35	2	A35-25ET	12,3	39	25	27	Yes	GEB3550	50
50	1/0	A50-20ET	15	36	20	22	Yes	GEB3550	50
50	1/0	A50-25ET	15	41	25	27	Yes	GEB3550	25

s = strip length

We can also offer end terminals with other colour codes and areas over 50 mm².

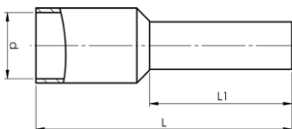

Pre-insulated end terminals 0.14 - 50 mm² ETT alternative colour



- Material: Cu 99.95%, tin plated Cu/Sn, CSA approved.
- Polypropylene insulation, colour code T.



mm ² (Cu)	AWG Cu	Name	d mm	L	L1	s	Measures acc DIN46228	Tool	Pcs/pack
0,14	26	A0,14-6ETT	1,9	10	6	8	No	PEB0110T	500
0,14	26	A0,14-8ETT	1,9	12	8	10	No	PEB0110T	500
0,25	24	A0,25-6ETT	1,9	10	6	8	No	PEB0110T	500
0,25	24	A0,25-8ETT	1,9	12	8	10	No	PEB0110T	500
0,34	22	A0,34-6ETT	1,9	10	6	8	No	PEB0110T	500
0,34	22	A0,34-8ETT	1,9	12	8	10	No	PEB0110T	500
0,5	20	A0,5-6ETT	2,4	12	6	8	No	PEB0110T	500
0,5	20	A0,5-8ETT	2,4	14	8	10	No	PEB0110T	500
0,5	20	A0,5-10ETT	2,4	16	10	12	Yes	PEB0110T	500
0,75	20	A0,75-6ETT	2,8	12	6	8	Yes	PEB0110T	500
0,75	20	A0,75-8ETT	2,8	14	8	10	Yes	PEB0110T	500
0,75	20	A0,75-10ETT	2,8	16	10	12	No	PEB0110T	500
0,75	20	A0,75-12ETT	2,8	18	12	14	No	PEB0110T	500
1	18	A1-6ETT	2,3	12	6	8	No	PEB0110T	500
1	18	A1-8ETT	3	14	8	10	No	PEB0110T	500
1	18	A1-10ETT	3	16	10	12	No	PEB0110T	500
1	18	A1-12ETT	3	18	12	14	No	PEB0110T	500
1,5	16	A1,5-6ETT	3,3	12	6	8	No	PEB0110T	500
1,5	16	A1,5-8ETT	3,3	14	8	10	No	PEB0110T	500
1,5	16	A1,5-10ETT	3,3	16	10	12	No	PEB0110T	500
1,5	16	A1,5-12ETT	3,3	18	12	14	No	PEB0110T	500
1,5	16	A1,5-18ETT	3,3	24	18	20	No	PEB0110T18	500
2,08	14	A2,08-8ETT	3,5	14	8	10	No	PEB0110T	500
2,5	14	A2,5-8ETT	4,2	15	8	10	No	PEB0110T	500
2,5	14	A2,5-10ETT	4,1	17	10	12	No	PEB0110T	500
2,5	14	A2,5-12ETT	4,2	19	12	14	No	PEB0110T	500
2,5	14	A2,5-18ETT	4,2	25	18	20	No	PEB0110T18	500
4	12	A4-10ETT	4,8	17	10	12	No	PEB0110T	500
4	12	A4-12ETT	4,8	20	12	14	No	PEB0110T	100
4	12	A4-18ETT	4,8	26	18	20	No	PEB0110T18	100
6	10	A6-12ETT	6,1	20	12	14	No	PEB0110T	100
6	10	A6-18ETT	6,1	26	18	20	No	PEB0110T18	100
10	8	A10-12ETT	7,4	21	12	14	No	GEB1025	100
10	8	A10-18ETT	7,4	27	18	20	No	GEB1025	100
16	6	A16-12ETT	8,8	23	12	14	No	GEB1025	100
16	6	A16-18ETT	8,8	29	18	20	No	GEB1025	100
25	4	A25-16ETT	10,9	29	16	18	No	GEB1025	50
25	4	A25-18ETT	10,9	31	18	20	No	GEB1025	50
25	4	A25-22ETT	10,9	35	22	24	No	GEB1025	50
35	2	A35-16ETT	12,3	30	16	18	No	GEB3550	50
35	2	A35-18ETT	12,3	32	18	20	No	GEB3550	50
35	2	A35-25ETT	12,3	39	25	27	No	GEB3550	50
50	1/0	A50-20ETT	15	36	20	22	No	GEB3550	50
50	1/0	A50-25ETT	15	41	25	27	No	GEB3550	25

s = strip length

We can also offer end terminals with other colour codes and areas over 50 mm².

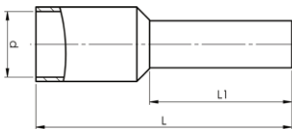

Pre-insulated end terminals 0.14 - 50 mm² ETD alternative colour



- Material: Cu 99.95%, tin plated Cu/Sn. CSA approved.
- Polypropylene insulation, size and colour code according to DIN46228 (see table).



mm ² (Cu)	AWG Cu	Name	d mm	L	L1	s	Measures acc DIN46228	Tool	Pcs/pack
0,14	26	A0,14-6ETD	1,9	10	6	8	No	PEB0110T	500
0,14	26	A0,14-8ETD	1,9	12	8	10	No	PEB0110T	500
0,25	24	A0,25-8ETD	1,9	12	8	10	No	PEB0110T	500
0,34	22	A0,34-6ETD	1,9	10	6	8	No	PEB0110T	500
0,34	22	A0,34-8ETD	1,9	12	8	10	No	PEB0110T	500
0,5	20	A0,5-6ETD	2,4	12	6	8	No	PEB0110T	500
0,5	20	A0,5-8ETD	2,4	14	8	10	No	PEB0110T	500
0,5	20	A0,5-10ETD	2,4	16	10	12	No	PEB0110T	500
0,75	20	A0,75-6ETD	2,8	12	6	8	Yes	PEB0110T	500
0,75	20	A0,75-8ETD	2,8	14	8	10	Yes	PEB0110T	100
0,75	20	A0,75-10ETD	2,8	16	10	12	Yes	PEB0110T	500
0,75	20	A0,75-12ETD	2,8	18	12	14	Yes	PEB0110T	500
1	18	A1-6ETD	3	12	6	8	No	PEB0110T	500
1	18	A1-8ETD	3	14	8	10	No	PEB0110T	100
1	18	A1-10ETD	3	16	10	12	No	PEB0110T	500
1	18	A1-12ETD	3	18	12	14	No	PEB0110T	500
1,5	16	A1,5-6ETD	3,3	12	6	8	No	PEB0110T	500
1,5	16	A1,5-8ETD	3,3	14	8	10	No	PEB0110T	100
1,5	16	A1,5-10ETD	3,3	16	10	12	No	PEB0110T	500
1,5	16	A1,5-12ETD	3,3	18	12	14	No	PEB0110T	500
1,5	16	A1,5-18ETD	3,3	24	18	20	No	PEB0110T18	500
2,08	14	A2,08-8ETD	3,5	14	8	10	No	PEB0110T	500
2,5	14	A2,5-8ETD	4,2	15	8	10	No	PEB0110T	500
2,5	14	A2,5-10ETD	4,1	17	10	12	No	PEB0110T	500
2,5	14	A2,5-12ETD	4,2	19	12	14	No	PEB0110T	500
2,5	14	A2,5-18ETD	4,2	25	18	20	No	PEB0110T18	500
4	12	A4-10ETD	4,8	17	10	12	No	PEB0110T	500
4	12	A4-12ETD	4,8	20	12	14	Yes	PEB0110T	100
4	12	A4-18ETD	4,8	26	18	20	Yes	PEB0110T18	100
6	10	A6-12ETD	6,1	20	12	14	No	PEB0110T	100
6	10	A6-18ETD	6,1	26	18	20	No	PEB0110T18	100
10	8	A10-12ETD	7,4	21	12	14	No	GEB1025	100
10	8	A10-18ETD	7,4	27	18	20	No	GEB1025	100
16	6	A16-12ETD	8,8	23	12	14	No	GEB1025	100
16	6	A16-18ETD	8,8	29	18	20	No	GEB1025	100
25	4	A25-16ETD	10,9	29	16	18	No	GEB1025	50
25	4	A25-18ETD	10,9	31	18	20	No	GEB1025	50
25	4	A25-22ETD	10,9	35	22	24	No	GEB1025	50
35	2	A35-16ETD	12,3	30	16	18	No	GEB3550	50
35	2	A35-18ETD	12,3	32	18	20	No	GEB3550	50
35	2	A35-25ETD	12,3	39	25	27	No	GEB3550	50
50	1/0	A50-20ETD	15	36	20	22	Yes	GEB3550	50
50	1/0	A50-25ETD	15	41	25	27	No	GEB3550	25

s = strip length

We can also offer end terminals with other colour codes and areas over 50 mm².

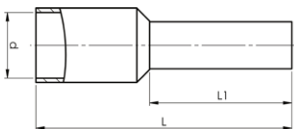

Uninsulated end terminals 0.25 - 50 mm²

• Material: Cu 99.95 %, tin plated Cu/Sn, dimension according to DIN 46228 (see table).



mm ²	AWG	Name	d mm	D	L	s	Tool	Measures acc DIN46228	Pcs/pack
0,25	24	B0,25-5ET	0,8	1,7	5	5	PEB0110T	No	1000
0,25	24	B0,25-7ET	0,8	1,7	7	7	PEB0110T	No	1000
0,34	22	B0,34-5ET	0,9	1,8	5	5	PEB0110T	No	1000
0,34	22	B0,34-7ET	0,9	1,8	7	7	PEB0110T	No	1000
0,5	20	B0,5-6ET	1	2,1	6	6	PEB0110T	Yes	1000
0,5	20	B0,5-8ET	1	2,1	8	8	PEB0110T	No	1000
0,5	20	B0,5-10ET	1	2,1	10	10	PEB0110T	Yes	1000
0,75	20	B0,75-6ET	1,2	2,3	6	6	PEB0110T	Yes	1000
0,75	20	B0,75-8ET	1,2	2,3	8	8	PEB0110T	No	1000
0,75	20	B0,75-10ET	1,2	2,3	10	10	PEB0110T	Yes	1000
0,75	20	B0,75-12ET	1,2	2,3	12	12	PEB0110T	No	1000
1	18	B1-6ET	1,4	2,5	6	6	PEB0110T	Yes	1000
1	18	B1-8ET	1,4	2,5	8	8	PEB0110T	No	1000
1	18	B1-10ET	1,4	2,5	10	10	PEB0110T	Yes	1000
1	18	B1-12ET	1,4	2,5	12	12	PEB0110T	No	1000
1,5	16	B1,5-7ET	1,7	2,8	7	7	PEB0110T	Yes	1000
1,5	16	B1,5-8ET	1,7	2,8	8	8	PEB0110T	No	1000
1,5	16	B1,5-10ET	1,7	2,8	10	10	PEB0110T	Yes	1000
1,5	16	B1,5-12ET	1,7	2,8	12	12	PEB0110T	Yes	1000
1,5	16	B1,5-15ET	1,7	2,8	15	15	PEB0110T	No	1000
1,5	16	B1,5-18ET	1,7	2,8	18	18	PEB0110T	Yes	1000
1,5	16	B1,5-20ET	1,7	2,8	20	20	PEB0110T	No	1000
2,5	14	B2,5-7ET	2,2	3,4	7	7	PEB0110T	Yes	1000
2,5	14	B2,5-8ET	2,2	3,4	8	8	PEB0110T	No	1000
2,5	14	B2,5-10ET	2,2	3,4	10	10	PEB0110T	Yes	1000
2,5	14	B2,5-12ET	2,2	3,4	12	12	PEB0110T	Yes	1000
2,5	14	B2,5-15ET	2,2	3,4	15	15	PEB0110T	No	1000
2,5	14	B2,5-18ET	2,2	3,4	18	18	PEB0110T	Yes	1000
2,5	14	B2,5-20ET	2,2	3,4	20	20	PEB0110T	No	1000
4	12	B4-9ET	2,8	4	9	9	PEB0110T	Yes	1000
4	12	B4-10ET	2,8	4	10	10	PEB0110T	No	1000
4	12	B4-12ET	2,8	4	12	12	PEB0110T	Yes	1000
4	12	B4-15ET	2,8	4	15	15	PEB0110T	Yes	1000
4	12	B4-18ET	2,8	4	18	18	PEB0110T	Yes	1000
4	12	B4-20ET	2,8	4	20	20	PEB0110T	No	1000
6	10	B6-10ET	3,5	4,7	10	10	PEB0110T	Yes	250
6	10	B6-12ET	3,5	4,7	12	12	PEB0110T	Yes	250
6	10	B6-15ET	3,5	4,7	15	15	PEB0110T	Yes	250
6	10	B6-18ET	3,5	4,7	18	18	PEB0110T	Yes	250
6	10	B6-20ET	3,5	4,7	20	20	PEB0110T	No	250
6	10	B6-25ET	3,5	4,7	25	25	PEB0110T	No	250
10	8	B10-12ET	4,5	4,7	12	12	GEB1025	No	250
10	8	B10-15ET	4,5	4,7	15	15	GEB1025	No	250
10	8	B10-18ET	4,5	4,7	18	18	GEB1025	No	250
10	8	B10-20ET	4,5	4,7	20	20	GEB1025	No	250
10	8	B10-25ET	4,5	4,7	25	25	GEB1025	No	250
16	6	B16-12ET	5,8	7,5	12	12	GEB1025	Yes	250
16	6	B16-15ET	5,8	7,5	15	15	GEB1025	Yes	250
16	6	B16-18ET	5,8	7,5	18	18	GEB1025	Yes	250
16	6	B16-20ET	5,8	7,5	20	20	GEB1025	No	250
16	6	B16-25ET	5,8	7,5	25	25	GEB1025	Yes	250
16	6	B16-32ET	5,8	7,5	32	32	GEB1025	Yes	250
25	4	B25-12ET	7,3	9,5	12	12	GEB1025	No	250
25	4	B25-15ET	7,3	9,5	15	15	GEB1025	Yes	250
25	4	B25-18ET	7,3	9,5	18	18	GEB1025	Yes	250
25	4	B25-25ET	7,3	9,5	25	25	GEB1025	Yes	100
25	4	B25-32ET	7,3	9,5	32	32	GEB1025	Yes	100
35	2	B35-18ET	8,3	11	18	18	GEB3550	Yes	100
35	2	B35-20ET	8,3	11	20	20	GEB3550	No	100
35	2	B35-22ET	8,3	11	22	22	GEB3550	No	100
35	2	B35-25ET	8,3	11	25	25	GEB3550	Yes	100
35	2	B35-32ET	8,3	11	32	32	GEB3550	Yes	100
50	1/0	B50-18ET	10,3	13	18	18	GEB3550	Yes	100
50	1/0	B50-22ET	10,3	13	22	22	GEB3550	No	100
50	1/0	B50-25ET	10,3	13	25	25	GEB3550	Yes	100
50	1/0	B50-32ET	10,3	13	32	32	GEB3550	Yes	100

s = strip length
We can also offer areas over 50 mm².

02

Pre-insulated TWIN-end terminals 2 x 0.5 - 2 x 10 mm² ET2 standard colour code



- Material: Cu 99.95%, tin plated Cu/Sn. CSA approved.
- Polypropylene insulation, colour code according to DIN 46228.

mm ² (Cu)	AWG Cu	Name	d mm	D	H	L	L1	s	Tool	Pcs/ pack
2 x 0,5	2x20	A0,5-6ET2	1,5	4,5	2,3	13	6	8	PEB0110T	100
2 x 0,5	2x20	A0,5-8ET2	1,5	4,5	2,3	15	8	10	PEB0110T	100
2 x 0,75	2x20	A0,75-8ET2	1,8	5,1	2,6	15	8	10	PEB0110T	100
2 x 0,75	2x20	A0,75-10ET2	1,8	5,1	2,6	17	10	12	PEB0110T	100
2 x 0,75	2x20	A0,75-12ET2	1,8	5,1	2,6	19	12	14	PEB0110T	100
2 x 1	2x18	A1-8ET2	2	5,1	3	15	8	10	PEB0110T	100
2 x 1	2x18	A1-10ET2	2	5,1	3	17	10	12	PEB0110T	100
2 x 1	2x18	A1-12ET2	2	5,1	3	19	12	14	PEB0110T	100
2 x 1,5	2x16	A1,5-8ET2	2,3	6,4	3,5	16	8	10	PEB0110T	100
2 x 1,5	2x16	A1,5-12ET2	2,3	6,4	3,5	20	12	14	PEB0110T	100
2 x 2,5	2x14	A2,5-10ET2	2,9	7,5	4	18,5	10	12	PEB0110T	100
2 x 2,5	2x14	A2,5-13ET2	2,9	7,5	4	21,5	13	15	PEB0110T18	100
2 x 4	2x12	A4-12ET2	3,8	8,6	4,9	23	12	14	GEB4010C-TWIN, PEB0110T	100
2 x 4	2x12	A4-18ET2	3,8	8,6	4,9	29	18	20	GEB4010C-TWIN, PEB0110T18	100
2 x 6	2x10	A6-14ET2	4,6	9,6	5,8	25	14	16	GEB4010C-TWIN, PEB0110T18	100
2 x 6	2x10	A6-18ET2	4,6	9,6	5,8	29	18	20	GEB4010C-TWIN, PEB0110T18	100
2 x 10	2x8	A10-14ET2	6,5	12,6	7	26	14	16	GEB4010C-TWIN	100

s = strip length

Use the tool socket closest to the total area of the sleeve.

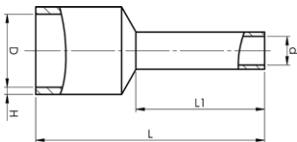
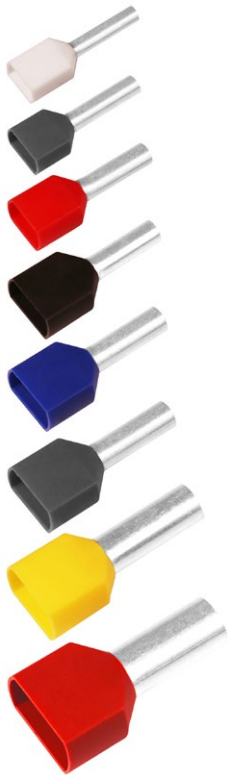

Pre-insulated TWIN-end terminals 2 x 0.5 - 2 x 10 mm² ETT2 alternative colour code

02



- Material: Cu 99.95%, tin plated Cu/Sn. CSA approved.
- Polypropylene insulation, colour code type T.

mm ² (Cu)	AWG Cu	Name	d mm	D	H	L	L1	s	Tool	Pcs/ pack
2 x 0,5	2x20	A0,5-6ETT2	1,5	4,5	2,3	13	6	8	PEB0110T	500
2 x 0,5	2x20	A0,5-8ETT2	1,5	4,5	2,3	15	8	10	PEB0110T	500
2 x 0,75	2x20	A0,75-8ETT2	1,8	5,1	2,6	15	8	10	PEB0110T	500
2 x 0,75	2x20	A0,75-10ETT2	1,8	5,1	2,6	17	10	12	PEB0110T	500
2 x 0,75	2x20	A0,75-12ETT2	1,8	5,1	2,6	19	12	14	PEB0110T	500
2 x 1	2x18	A1-8ETT2	2	5,1	3	15	8	10	PEB0110T	500
2 x 1	2x18	A1-10ETT2	2	5,1	3	17	10	12	PEB0110T	500
2 x 1	2x18	A1-12ETT2	2	5,1	3	19	12	14	PEB0110T	500
2 x 1,5	2x16	A1,5-8ETT2	2,3	6,4	3,5	16	8	10	PEB0110T	500
2 x 1,5	2x16	A1,5-12ETT2	2,3	6,4	3,5	20	12	14	PEB0110T	500
2 x 2,5	2x14	A2,5-10ETT2	2,9	7,5	4	18,5	10	12	PEB0110T	250
2 x 2,5	2x14	A2,5-13ETT2	2,9	7,5	4	21,5	13	15	PEB0110T18	250
2 x 4	2x12	A4-12ETT2	3,8	8,6	4,9	23	12	14	GEB4010C-TWIN, PEB0110T	100
2 x 4	2x12	A4-18ETT2	3,8	8,6	4,9	29	18	20	GEB4010C-TWIN, PEB0110T18	100
2 x 6	2x10	A6-14ETT2	4,6	9,6	5,8	25	14	16	GEB4010C-TWIN, PEB0110T18	100
2 x 6	2x10	A6-18ETT2	4,6	9,6	5,8	26	18	20	GEB4010C-TWIN, PEB0110T18	100
2 x 10	2x8	A10-14ETT2	6,5	12,6	7	26	14	16	GEB4010C-TWIN	100

s = strip length
Use the tool socket closest to the total area of the sleeve.

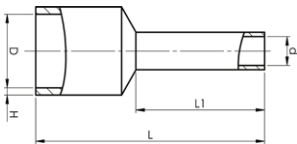
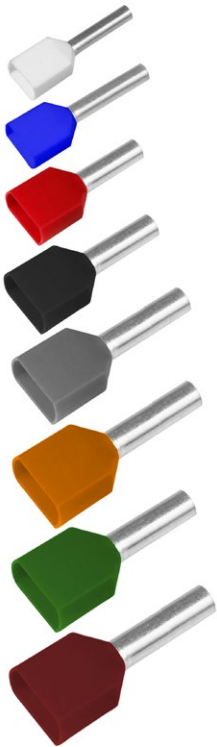

Pre-insulated TWIN-end terminals 2 x 0.5 - 2 x 10 mm² ETW2 alternative colour code



- Material: Cu 99.95%, tin plated Cu/Sn. CSA approved.
- Polypropylene insulation, colour code type W.



mm ² (Cu)	AWG Cu	Name	d mm	D	H	L	L1	s	Tool	Pcs/ pack
2 x 0,5	2x20	A0,5-6ETW2	1,5	4,5	2,3	13	6	8	PEB0110T	500
2 x 0,5	2x20	A0,5-8ETW2	1,5	4,5	2,3	15	8	10	PEB0110T	500
2 x 0,75	2x20	A0,75-8ETW2	1,8	5,1	2,6	15	8	10	PEB0110T	500
2 x 0,75	2x20	A0,75-10ETW2	1,8	5,1	2,6	17	10	12	PEB0110T	500
2 x 0,75	2x20	A0,75-12ETW2	1,8	5,1	2,6	19	12	14	PEB0110T	500
2 x 1	2x18	A1-8ETW2	2	5,1	3	15	8	10	PEB0110T	500
2 x 1	2x18	A1-10ETW2	2	5,1	3	17	10	12	PEB0110T	500
2 x 1	2x18	A1-12ETW2	2	5,1	3	19	12	14	PEB0110T	500
2 x 1,5	2x16	A1,5-8ETW2	2,3	6,4	3,5	16	8	10	PEB0110T	500
2 x 1,5	2x16	A1,5-12ETW2	2,3	6,4	3,5	20	12	14	PEB0110T	500
2 x 2,5	2x14	A2,5-10ETW2	2,9	7,5	4	18,5	10	12	PEB0110T	250
2 x 2,5	2x14	A2,5-13ETW2	2,9	7,5	4	21,5	13	15	PEB0110T18	250
2 x 4	2x12	A4-12ETW2	3,8	8,6	4,9	23	12	14	GEB4010C-TWIN, PEB0110T	100
2 x 4	2x12	A4-18ETW2	3,8	8,6	4,9	26	18	20	GEB4010C-TWIN, PEB0110T18	100
2 x 6	2x10	A6-14ETW2	4,6	9,6	5,8	25	14	16	GEB4010C-TWIN, PEB0110T18	100
2 x 6	2x10	A6-18ETW2	4,6	9,6	5,8	29	18	20	GEB4010C-TWIN, PEB0110T18	100
2 x 10	2x8	A10-14ETW2	6,5	12,6	7	26	14	16	GEB4010C-TWIN	100

s = strip length

Use the tool socket closest to the total area of the terminal.

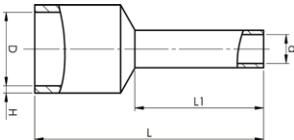

Assortment boxes - end terminals



PL800ET with tools



Elpress assortment boxes for professional use.

Properties:

- made of polypropylene, insert made of polystyrene
- 11 compartments
- 800 pre-insulated end sleeves 0.5-16 mm² type ET, colour code W
- stripping tool SCT001

mm ²	AWG	Name	Net weight (kg)	Length mm	Width	Height
0,5-16	20-6	PL800ET-PEB0116H	0,993	245,5	215,0	56,5
0,5-16	20-6	PL800ET-PEB0116S	0,9885	245,5	215,0	56,5



CE

RPL5548



RPL5548 is a complete assortment box for electricians who like to keep things neat and tidy. A system solution for storing high quality tools and end sleeves that are used daily.

Properties:

- practical and safe design for stacking. Comes with removable inserts, perfect for easy refilling of terminals.
- the box contains 1550 end terminals 0.14-10 mm², the PEB0110T crimping tool and the CT10 stripping tool.

mm ²	AWG	Name	Net weight (kg)	Length mm	Width	Height
0,14-10	26-8	RPL5548	1,46	261	338	57



CE

SD4016



Elpress hanging assortment box.

Properties:

- made of plastic
- 5 compartments
- 100 pre-insulated end sleeves 4 - 16 mm² type ET, colour code W

mm ²	AWG	Name	Net weight (kg)	Length mm	Width	Height
4-16	12-6	SD4016	0,104	165,0	58,0	38,0



CE

SD0525



Elpress hanging assortment box.

Properties:

- made of plastic
- 5 compartments
- 400 pre-insulated end sleeves 0.5 - 2.5 mm² type ET, colour code W

mm ²	AWG	Name	Net weight (kg)	Length mm	Width	Height
0,5-2,5	20-14	SD0525	0,106	165,0	58,0	38,0



ELPRESS

Miniforce tool for end terminals 0.14 - 16 mm² with measuring certificate



- Properties:
- small and compact, ideal for confined spaces
- locking function which only releases once crimping is complete
- well balanced so the tool does not slip out of your hand
- high friction grip allows the tool to be used with a table as support
- custom hole to attach a safety line
- ergonomically designed handle made of grip friendly material
- minimum handle force required when crimping larger areas
- emergency release if the crimping process has to be interrupted
- tested with Elpress terminals
- supplied with certificate for basic quality monitoring



PEB0116S

Tested and certified mechanical Miniforce hand tool for crimping end terminals 0.14-16 mm² with square crimping.

mm ²	AWG	Name	Crimp geometry	Net weight (kg)	Length	Width
0,14-16,0	26-6	PEB0116S	Square	0,371	176	62



Crimp geometry



PEB0116H

Tested and certified mechanical Miniforce hand tool for crimping end terminals 0.14-16 mm² with hexagonal crimping.

mm ²	AWG	Name	Crimp geometry	Net weight (kg)	Length	Width
0,14-16,0	26-6	PEB0116H	Hexagonal	0,379	176	62



Crimp geometry



PEB0110T and PEB0110T18

Tested and certified mechanical Miniforce hand tools for crimping end terminals 0.14-10 mm².

Special properties:

- Rotating die
- Front and side feed

mm ²	AWG/MCM (Cu)	Name	Crimp geometry	Net weight (kg)	Length	Width
0,14-10	26-8	PEB0110T	Trapezoid	0,385	180	65
0,14-10	26-8	PEB0110T18	Trapezoid	0,300	180	25



Crimp geometry



Miniforce-tool for end terminals 0.25 - 4 mm² with measurement certificates



Properties:

- locking function which only releases once crimping is complete
- emergency release if the crimping process has to be interrupted
- symmetrical and clearly marked crimping positions
- adjustable for changes after long use
- tested with Elpress terminals
- unique mechanism that reduces maximum handle force from 450 N right down to 250 N (model C)
- ergonomic handle suitable for all users
- maximises the quality of work
- reduces the risk of occupational injuries
- light and versatile design without sacrificing on strength
- model C has extra long handles for the use of both hands
- withstands at least 80,000 crimps
- supplied with certificate for basic quality monitoring



GSEA0340C



Tested and certified mechanical Miniforce hand tool for crimping pre-insulated terminals 0.5-2.5 mm² as well as pre-insulated and uninsulated end sleeves 0.25-4 mm².

mm ²	AWG	Name	Crimp geometries	Net weight (kg)	Length mm	Width
0,5-2,5 / 0,25-4	20-14 / 22-12	GSEA0340C	Oval, Trapezoid	0,613	256	80

Crimp geometries



Miniforce tool for end terminals 0.1 - 6 mm² and TWIN end terminals 2 x 0.5 - 2 x 10 mm²



Properties

- locking function which only releases once crimping is complete
- emergency release if the crimping process has to be interrupted
- clearly marked crimping positions
- adjustable in case of changes due to long-term use
- tested with Elpress terminals
- ergonomic handle suitable for all users
- maximises the quality of work
- reduces the risk of occupational injuries
- light and versatile design without compromising durability
- model C has extra long handles for the use of both hands
- withstands at least 80,000 crimps
- supplied with certificate for basic quality monitoring



GEB4010C-TWIN



Tested and certified mechanical Miniforce hand tool for crimping pre-insulated TWIN end terminals 2 x 4-2 x 10 mm².

mm ²	AWG	Name	Crimp geometry	Net weight (kg)	Length mm	Width
4-10	12-8	GEB4010C-TWIN	Trapezoid	0,618	256	80

Crimp geometry



PZD3



Tested and certified mechanical hand tool for crimping end terminals 0.5-6 mm² and insulated TWIN end terminals 2 x 0.5-2 x 4 mm².

Special properties:

- a crimp mode that automatically adjusts itself
- front-fed
- can handle crimp lengths up to 17 mm

Crimp geometry



mm ²	AWG	Name	Crimp geometry	Net weight (kg)	Length mm	Width
0,5-6	20-10	PZD3	Rectangle	0,472	192	66



Miniforce tool for end terminals 4 - 50 mm² with measurement certificate



Properties:

- locking function which only releases once crimping is complete
- emergency release if the crimping process has to be interrupted
- clearly marked crimping positions
- adjustable in case of changes due to long-term use
- tested with Elpress terminals
- ergonomic handle suitable for all users
- maximises the quality of work
- reduces the risk of occupational injuries
- light and versatile design without compromising durability
- model C has extra long handles for the use of both hands
- withstands at least 80,000 crimps
- supplied with certificate for basic quality monitoring



GEB4010C



Tested and certified mechanical Miniforce hand tool for crimping end terminals 4-10 mm².

mm ²	AWG	Name	Crimp geometry	Net weight (kg)	Length mm	Width
4-10	12-8	GEB4010C	Trapezoid	0,615	256	80

Crimp geometry



GEB1025 and GEB1025C



Tested and certified mechanical Miniforce hand tools for crimping end terminals 10-25 mm².

mm ²	AWG	Name	Crimp geometry	Net weight (kg)	Length mm	Width
10-25	8-4	GEB1025	Trapezoid	0,558	203	76
10-25	8-4	GEB1025C	Trapezoid	0,62	256	80



Crimp geometry





GEB3550 and GEB3550C

Tested and certified mechanical Miniforce hand tools for crimping end terminals 35-50 mm².



mm ²	AWG	Name	Crimp geometry	Net weight (kg)	Length mm	Width
35-50	2	GEB3550	Trapezoid	0,558	203	76
35-50	2	GEB3550C	Trapezoid	0,614	256	80

Crimp geometry



Battery-powered crimping tools for pre-insulated 0.5 - 6 mm² terminals, uninsulated 0.25 - 10 mm² terminals and 0.5 - 50 mm² end sleeves

Properties:

- Li-ion battery powered (10.8 V and 2 Ah), charging time about 40 min
- very good accessibility and ergonomics
- service and installation tools
- fast crimping process 2 – 4 sec
- approximately 230 crimps/battery charge
- dies for the tool sold separately



PVL130P - Elpress Mini

Elpress mini tool with a sleek design with a high performance Li-Ion battery that facilitates your work with its improved battery capacity. Crimping force max. 13 kN. 1 x Li-ion battery and charger included.

Properties:

- one-handed operation for easy control of all tool functions
- durable crimping head for long service life
- optimal crimping thanks to parallel-moving dies
- easy to use due to its low weight
- high-performance 12 V Li-Ion battery – with indication of charge status
- open head, rotating
- easy and comfortable to use one handed thanks to its ergonomic 2-component housing with grip-friendly protection
- automatic return of dies when crimping is complete



PVL130P - Elpress MINI, dies sold separately.

mm ² (Cu)	AWG (Cu)	Name	Net weight (kg)	Length	Width	Height	Note
0,25-50	24-1/0	PVL130P	1,5	330	85	60	Charger: 230VAC
0,25-50	24-1/0	PVL130P-US	1,5	330	85	60	Charger: 115VAC
0,25-50	24-1/0	PVL130P-WOBC	0,91	330	85	60	without Battery/ Charger



PVL130P, case and charger.





PVL130S - Elpress Mini

Elpress mini tools with intuitive PowerSense function combine the benefits of manual crimping tools with the benefits of battery-powered hydraulic crimping tools.

Crimping force max. 15 kN. 1 x Li-ion battery and charger included.



PVL130S - Elpress MINI, supplied with die pair SA0760.

Properties:

- one-handed operation for easy control of all tool functions
- electronic control with locking function and monitoring for complete closure of the jaws
- safety loop used as fall protection when used outdoors
- motor protection ensures safety in case of overload
- easy and comfortable to use one handed thanks to its ergonomic 2-component housing with grip-friendly protection
- very low weight and fast crimping process for maximum efficiency
- powerful driving technology allows for easy crimps
- high-performance 12 V Li-Ion battery – with indication of charge status
- LED work lighting
- Die pair SA0760 comes with the tool

mm ² (Cu)	AWG (Cu)	Name	Net weight (kg)	Length	Width	Height	Note
0,25-50	24-1/0	PVL130S	1,5	58	92	250	Charger: 230VAC
0,25-50	24-1/0	PVL130S-US	1,5	58	92	250	Charger: 115VAC
0,25-50	24-1/0	PVL130S-WOBC	0,91	58	92	250	without Battery/Charger



Dies for PVL130P/PVL130S



EB0560



WB4099



KB0325



EB3550



EB1025



EB4010



RB0560



SA0760

mm ² (Cu)	AWG (Cu)	Name	Crimp geometry	Net weight (kg)	Application
0,5-6	20-10	SA0760	Oval	0,05	Pre-insulated terminals
0,25-2,5	22-14	KB0325	Tab	0,039	Uninsulated terminals
4-10	12-8	WB4099	W	0,05	Uninsulated terminals
0,5-6	20-10	RB0560	Roll	0,05	Uninsulated terminals
0,5-6	20-10	EB0560	Trapezoid	0,057	End sleeves
4-10	12-8	EB4010	Trapezoid	0,05	End sleeves
10-25	6-4	EB1025	Trapezoid	0,05	End sleeves
35-50	2-0	EB3550	Trapezoid	0,05	End sleeves



Elpress Mobile - tool with interchangeable dies



Professional contact crimping tool with interchangeable dies for the installer or service technician.

Properties:

- reliable, safe, economic and ergonomic tools
- parallel-moving crimping movement with 10 kN crimping force, tested for 20,000 crimps
- change crimping dies quickly and easily in one operation
- the crimping dies are kept together in pairs and stored in custom holders
- wide selection of dies allows you to use one tool frame for 19 different crimping applications!



Elpress Mobile, frame only.

Elpress Mobile

Mobile hand tool (frame only). Dies are supplementary.

mm ²	AWG	Name	Net weight (kg)	Length mm	Width
0,25-10	24-8	MOBILE	0,554	234	64



Elpress Mobile + dies OAA0525 and OEB0210.

Mobile Installation

Mobile hand tool with two interchangeable dies:

- Die OAA0525 for crimping pre-insulated 0.5 - 2.5 mm² terminals.
- Die OEB0210 for crimping end sleeves 0.25 - 10 mm².
- The tool comes with associated dies in blister packaging.

Name	Net weight (kg)	Length mm	Width
MOBILE INSTALLATION	0,695	234	64



Elpress Mobile + dies OMP45 and OCC1113.

Mobile DataCom

Mobile hand tool with two interchangeable dies:

- OMP45 for crimping modular plug RJ45.
- OCC1113 for crimping coaxial contacts RG58, RG59, RG62 and RG71.
- The tool comes with associated dies in blister packaging.

Name	Net weight (kg)	Length mm	Width
MOBILE DATA/COM	0,667	234	64





Mobile Box

Box for the mobile tool with room for the tool as well as 5-6 associated dies.
Tools and dies are ordered separately.

Name	Net weight (kg)	Length mm	Width	Height
MOBILE BOX	0,32	246	218	57

Additional dies for Elpress Mobile

All dies have the same quick and easy way of being inserted into the tool frame. The dies are kept together in pairs and supplied in a cassette that can be docked to other cassettes.



OAA0160
Crimping die for Elpress MOBILE tool for asymmetric crimping of pre-insulated terminals 0.1-4 mm² and 4-6 mm².
AWG 11-9.



OAA0525
Crimping die for Elpress MOBILE tool for asymmetric crimping of pre-insulated terminals 0.5-2.5 mm².
AWG 20-13.



OSW0360
Crimping die for Elpress MOBILE tool for crimping through connectors with heat shrink insulation 0.3-0.75 mm² and 4-6 mm².
AWG 11-9.



OSW0525
Crimping die for Elpress MOBILE tool for crimping through connectors with heat shrink insulation 0.5-1.5 mm² and 1.5-2.5 mm².
AWG 15-13.



OPB0140
Crimping die for Elpress MOBILE tool for crimping global power connectors, GPC connectors.



OPB6099
Crimping die for Elpress MOBILE tool for crimping global power connectors, GPC connectors.



OWB4099
Crimping die for Elpress MOBILE tool for W crimping of uninsulated terminals 4-10 mm².
AWG 11-7.



OKB0725
Crimping die for Elpress MOBILE tool for punch crimping uninsulated terminals 0.75-2.5 mm².
AWG 18-13.



OKB0560
Crimping die for Elpress MOBILE tool for punch crimping uninsulated terminals 0.5-6 mm².
AWG 20-9.



OEB0210
Crimping die for Elpress MOBILE tool for crimping end sleeves 0.25-10 mm².
AWG 24-7.



OEB1625
Crimping die for Elpress MOBILE tool for crimping end sleeves 16-25 mm².
AWG 5-3.



OEB3550
Crimping die for Elpress MOBILE tool for crimping end sleeves 35-50 mm².
AWG 2-1/0.



ORB0110
Crimping die for Elpress MOBILE tool for roll crimping uninsulated terminals 0.1-1 mm².
AWG 26-17.



ORB0560
Crimping die for Elpress MOBILE tool for roll crimping uninsulated terminals 0.5-6 mm².
AWG 20-9.



OMP45
Crimping die for Elpress MOBILE tool for crimping modular plug RJ45.



OMP11
Crimping die for Elpress MOBILE tool for crimping modular plug RJ11.



OFO5432
Crimping die for Elpress MOBILE tool for crimping fibre optic contacts.



OCC0908
Crimping die for Elpress MOBILE tool for crimping coaxial contacts RG174, 179.



OCC1113
Crimping die for Elpress MOBILE tool for crimping coaxial contacts RG58, 59, 62, 71.



OCC4755
Crimping die for Elpress MOBILE tool for crimping coaxial contacts RG6, 59.



OMS4
Dies for Mobile tools for roll crimping contacts with sleeve diameter 4 mm, 2.5-6.0 mm².
AWG 13-19.



OMSL
Die for square crimping contacts 2.5-6.0 mm².
AWG 13-9.



Uninsulated terminals 0.15 - 10 mm² with associated tools

General information about uninsulated terminals.....	2
Hand tools for uninsulated terminals	3
Ring terminal 0.25 - 6 mm ²	4
Tube terminal 0.75 - 10 mm ²	5
Fork terminals 0.25 - 10 mm ²	6
Pin terminals 0.25 - 6 mm	6
Jointing sleeves 0.75 - 10 mm ²	7
Receptacles rolled type 0.5 - 6 mm ²	8
Receptacles with locking lip rolled type 0.5 - 6 mm ²	8
Multiple tabs, rolled type (piggy back) 0.5 - 2.5 mm ²	9
Receptacles 90° rolled type 0.5 - 1.5 mm ²	9
Receptacle angled rolled type 0.5 - 1 mm ²	9
Tab 0.5 - 2.5 mm ²	10
Tab with locking lip 0.5 - 6 mm ²	10
Bullet and Socket 0.2 - 1.5 mm ²	10
Tab with one male, 2 males and 3 males	11
Tab connectors, Tab connectors 45°, Tab connectors 90°.....	12
Tab connectors 2 x 45°	13
Tab for soldering with 2 solder pins	13
Tab for soldering med 2 solder pins, 90°	13
Tab for soldering med 1 solder pins	14
Insulation boot ISO1003FL1, ISO1005FL1 and ISO1507H-BW6	15
Insulation boot ISO1507FLS, ISO2507FLS1 and ISO1507FLB.....	16
Connector block for receptacles 1.5 - 6 mm ²	17
Connector block for bullets and sockets 0.2 - 1.5 mm ²	17
Connector block for receptacles - 400 V /18 A.....	18
Assortment box - uninsulated terminals	18
Hobby tools for pre-insulated and uninsulated 0.5 - 6 mm ² terminals.....	19
T50, T51 and T52 Hobby tool.....	19
Tool for uninsulated terminals 0.15 - 6 mm ²	20
TRB0515B, DRB0115 and DKB0325	20
DKB0760.....	21
Miniforce tool for uninsulated terminals 0.5 - 10 mm ²	22
GRB0560L and GRB0560LC	22
GRB0560, GRB0560C, GWB4099 and GWB4099C	23
Battery-powered crimping tools	24
PVL130P - Elpress Mini.....	24
PVL130S - Elpress Mini.....	25
Elpress Mobile - tool with interchangeable dies.....	26
Elpress Mobile, Mobile Installation & Mobile DataCom	26
Mobile Solar Kit and Mobile Box.....	27
Additional dies for Elpress Mobile	28

General information about uninsulated terminals



System Elpress

System Elpress consists of terminals and tools that are designed and tested together to give a certified crimping result. This ensures that users will feel confident when using our systems, and that a secure connection will be achieved through the proper handling of our products.

Uninsulated terminals

Elpress through connectors, ring, pipe, fork and pin terminals are made of high-quality copper 99.95%. The receptacles and sockets are made of brass. All terminals are then electro-tin plated for maximum corrosion protection. Terminals made of copper bands have a brazed neck which is soldered, which means that it can be crimped in any direction.

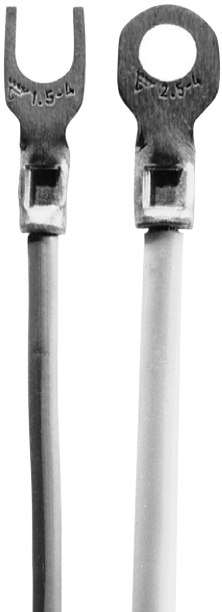

Examples of crimps using Elpress uninsulated terminals.

Marking of uninsulated terminals

Elpress uninsulated terminals are marked with logotype, area and any screw diameter to facilitate work and checkability.

Designation example

Cat no B1532R (G, HO, FLS etc)

- B = uninsulated
- 15 = Area (1.5 mm²)
- 32 = Characteristic dimension (Hole 3.2 mm)
- G = fork terminals
- GS = fork terminal
- H = tabs (male)
- HN = tab with locking lip
- HA = bullet
- HO = socket
- R = ring terminals
- SR = pin terminal
- FLS = receptacle, rolled type
- FLSB = receptacle 90 rolled type
- FLSH = receptacle w male rolled type
- FLSN = receptacle w locking lip rolled model
- FLSV = receptacle angled rolled model

Screw and washer

The following apply for bright galvanized type nuts and screws, with strength class 8.8, used for connecting terminals with Cu and Al palms:

- Always use a torque wrench to be certain the right torque is achieved. Make sure it is calibrated at regular intervals according to the supplier's instructions.
- Use the recommended torque according to the screw manufacturer's instructions.
- Always use a hard flat washer to reduce friction against the connection surface and the edge pressure, hardness min HB200.
- Install as illustrated.

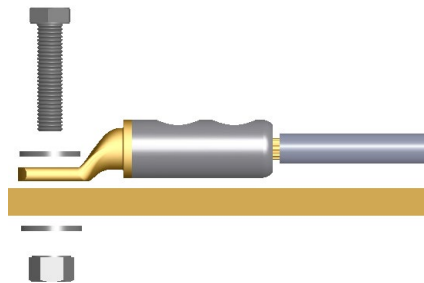

IEC recommendations

IEC - The International Electrical Commission - publishes internationally viable standards which, although not directly binding, often have great impact and are used as the basis for international deliveries. A technical report, IEC 61238-2, sets out the following recommendations regarding screw sizes for connecting terminals with Cu and Al plate provided that mounting takes place with a washer and with the correct tightening torque.

Conductor area, mm² Screw

Conductor area, mm ²	Screw
10	M6
16-50	M8
70-95	M10
120-300	M12
400-500	M16



UL-approved terminals

KR/KS, KRF/KSF, KRFS, KRT/KST UL approved in accordance with file no. E205350. UL certified products are delivered with UL marking on the label including the UL file number and/or certification code for control by an UL inspector. The certificate can be downloaded at UL Product IQ.

Hand tools for uninsulated terminals

Mechanical tools

In the development of a mechanical crimping tool at Elpress, we strive for the best quality and ergonomics in the actual tool, and the best characteristics in the crimped terminal. The tools have a built-in locking system (not the hobby tools) that ensures that the entire crimping process is completed - a prerequisite for professional and quality-assured work.



Elpress Mobile, professional tool with interchangeable dies for the installer or service technician.

Miniforce-tools

With the unique Miniforce tools, a new level has been established regarding ergonomic adaptation to the user and low force requirements. This has meant a decrease in the grip forces by up to 45% and is the result of an advanced development process where minimisation of the risks of work-related injuries and the best ergonomics have been the deciding factors.



Miniforce type C has longer handles to facilitate two-handed operation, which is often a simple and natural way to reduce the loads. Electrical crimping tools and terminals together constitute a contact crimping system where crimping results are continuously checked against the requirements of established standards such as IEC 60352-2, SEN 245010, DIN 46429, IEC 61238-1 etc. Many of the manual tools have symmetrical crimp positions that make it possible to work from both sides - something that is important for left-handed users. The tools in the Miniforce, D and 50 series are made of very high-grade hardened steel with a black oxide finish and are laser marked.



Certification of crimping tools

For quality assurance of our tools, we already certify the manufacture of our crimping tools, both hand tools, type Gxx, i.e. Miniforce tools, and type Dxx.



What do we certify?

Certification of the crimping tools means that each individual tool is documented at the final assembly and inspection stage with respect to:

- **handle pre-load**, which is the force needed to ensure that the lock, which prevents a crimp from being interrupted, is not released too early.
- **crimp die nest heights**, i.e. the maximum height measurements which can be measured in each indentation with the dies pressed together.

Why certification?

The certificate that accompanies the tool serves several functions:

- crimping tools are often directly introduced upon procurement in a quality management system. The tool's status at procurement shall of course be the first thing noted, to then be followed by regular checks where potential changes can be discovered and addressed.
- the certificate shows that each individual tool meets the requirements of the tool's basic specifications.
- the certificate states what the most important characteristics are that shall be followed up.

Elpress' service department offers the possibility of continued follow-up of the quality of the tools.

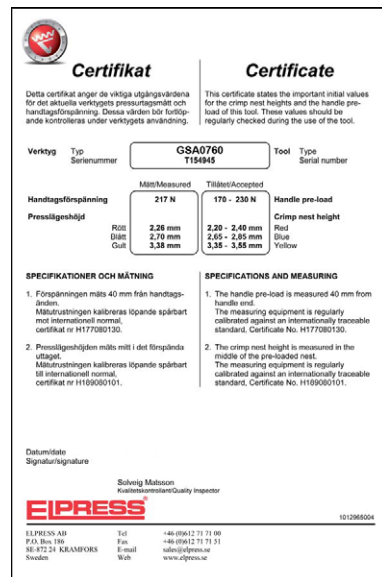

Certificate that accompanies the tool.



Get your certificate.



Elpress ergonomic Miniforce tool.

Ring terminal 0.25 - 6 mm²

• Material: Cu 99.95%, tin plated, brazed neck.

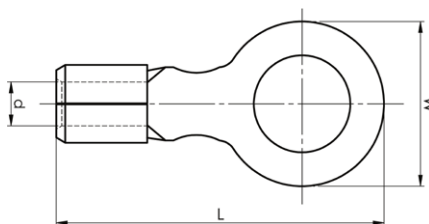

mm ² (Cu)	AWG Cu	Name	Screw	W mm	d	L	t	s	Neck type	Tool	Pcs/pack
0,25-0,75	24-20	B0832R	M3	5,5	1,3	13	0,5	7	Brazed	DKB0325	100
0,25-0,75	24-20	B0843R	M4	7,5	1,3	16,2	0,5	7	Brazed	DKB0325	100
0,25-0,75	24-20	B0853R	M5	9	1,3	17	0,5	7	Brazed	DKB0325	100
0,75-1,5	20-16	B1532R	M3	5,5	1,8	14	0,7	7	Brazed	DKB0325, DKB0760	100
0,75-1,5	20-16	B1543R	M4	7	1,8	16	0,7	7	Brazed	DKB0325, DKB0760	100
0,75-1,5	20-16	B1553R	M5	9	1,8	18	0,7	7	Brazed	DKB0325, DKB0760	100
0,75-1,5	20-16	B1565R	M6	11	1,8	21,5	0,7	7	Brazed	DKB0325, DKB0760	100
0,75-1,5	20-16	B1585R	M8	14	1,8	23	0,7	7	Brazed	DKB0325, DKB0760	100
0,75-1,5	20-16	B1510R	M10	16,5	1,8	25,8	0,7	7	Brazed	DKB0325, DKB0760	100
1,5-2,5	16-14	B2532R	M3	6	2,3	15	0,8	8	Brazed	DKB0325, DKB0760	100
1,5-2,5	16-14	B2537R	M3,5	6	2,4	14	0,8	7	Brazed	DKB0325, DKB0760	100
1,5-2,5	16-14	B2543R	M4	7	2,4	16	0,8	8	Brazed	DKB0325, DKB0760	100
1,5-2,5	16-14	B2553R	M5	9	2,4	18	0,8	8	Brazed	DKB0325, DKB0760	100
1,5-2,5	16-14	B2565R	M6	11	2,4	21,5	0,8	8	Brazed	DKB0325, DKB0760	100
1,5-2,5	16-14	B2585R	M8	14	2,4	23	0,8	8	Brazed	DKB0325, DKB0760	100
1,5-2,5	16-14	B2510R	M10	16,5	2,4	25,75	0,7	8	Brazed	DKB0325, DKB0760	100
4-6	12-10	B4643R	M4	7,8	3,4	17,5	1	9	Brazed	DKB0760	100
4-6	12-10	B4653R	M5	9	3,4	18	1	9	Brazed	DKB0760	100
4-6	12-10	B4665R	M6	11	3,4	21,5	1	9	Brazed	DKB0760	100
4-6	12-10	B4685R	M8	14	3,4	24	1	9	Brazed	DKB0760	100
4-6	12-10	B4610R	M10	17	3,4	27,5	1	9	Brazed	DKB0760	100
4-6	12-10	B4613R	M13	19,2	3,4	32,5	1	9	Brazed	DKB0760	100

t = palm thickness, s = strip length

Tube terminal 0.75 - 10 mm²

- Material: Cu 99.95%, tin plated Cu/Sn.
- For multi-stranded (Class 5) and get-stranded (Class 2) Cu conductors.
- UL approved (1.5 - 10 mm²).



Examples of plate marking KR: 10 10

10 = mm² 10 = Plate hole for M10

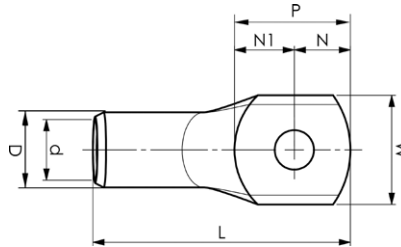

mm ² (Cu)	AWG Cu	Name	Screw	W mm	d	N	N1	P	L	t	s	Tool	Inspection hole	Pcs/ pack	Die
0,75	(22)-18	KR0,75-3	M3	6	1,3	3,2	3,8	7	17	0,85	7,5	DKB0325, DKB0760	No	100	
0,75	(22)-18	KR0,75-4	M4	6	1,3	3,2	3,5	6,7	17	0,8	7,5	DKB0325, DKB0760	No	100	
1,5	(18)-16	KR1,5-3	M3	6,5	1,8	3,4	3,6	7	16	1	7,5	DKB0325, DKB0760	No	100	
1,5	(18)-16	KR1,5-4	M4	6,5	1,8	4,2	3,8	8	17	0,9	7,5	DKB0325, DKB0760	No	100	
1,5	(18)-16	KR1,5-5	M5	7,5	1,8	4,8	4,7	9,5	18	0,85	7,5	DKB0325, DKB0760	No	100	
2,5	(16)-14	KR2,5-3	M3	7,5	2,3	3,5	4,1	7,6	17	1,3	7	DKB0325, DKB0760	No	100	
2,5	(16)-14	KR2,5-4	M4	7,5	2,3	4,2	4,1	8,3	18	1,3	7	DKB0325, DKB0760	No	100	
2,5	(16)-14	KR2,5-5	M5	8,5	2,3	4,8	4,8	9,6	19	1,1	7	DKB0325, DKB0760	No	100	
2,5	(16)-14	KR2,5-6	M6	8,5	2,4	5,1	5,8	10,9	19	1,1	7	DKB0325, DKB0760	No	100	
4	12	KR4-3	M3	8,5	3	4,2	5,8	10	21	1,5	8,5	GWB4099, ES2258	Yes	100	
4	12	KR4-4	M4	8,5	3	4,2	5,8	10	22	1,5	8,5	GWB4099, ES2258	Yes	100	
4	12	KR4-5	M5	9	3	4,8	5,2	10	22	1,5	8,5	GWB4099, ES2258	Yes	100	
4	12	KR4-6	M6	9,9	3	5	7	12	23	1,3	8,5	GWB4099, ES2258	Yes	100	
6	10	KR6-4	M4	9,5	4	4	6	10	22	1,7	8,5	GWB4099, ES2258	Yes	100	
6	10	KR6-5	M5	9,5	4	5	6	11	22	1,7	8,5	GWB4099, ES2258	Yes	100	
6	10	KR6-6	M6	9,9	4	5,5	6,5	12	23	1,6	8,5	GWB4099, ES2258	Yes	100	
6	10	KR6-8	M8	13	4	7	10	17	30	1,2	8,5	GWB4099, ES2258	Yes	100	
10	8	KR10-4	M4	11,5	5	6	8	14	29	2,9	11	GWB4099, ES2258, PVL350, V600, DV1300	Yes	100	8
10	8	KR10-5	M5	11,5	5	6	7,5	13,5	29	2,9	11	GWB4099, ES2258, PVL350, V600, DV1300	Yes	100	8
10	8	KR10-6	M6	11,5	5	6	7,5	13,5	29	3	11	GWB4099, ES2258, PVL350, V600, DV1300	Yes	100	8
10	8	KR10-8	M8	13,5	5	7,5	8,5	16	33	2,3	11	GWB4099, ES2258, PVL350, V600, DV1300	Yes	100	8
10	8	KR10-10	M10	16	5	8	10	18	34	2	11	GWB4099, ES2258, PVL350, V600, DV1300	Yes	100	8
10	8	KR10-12	M12	18,5	5	10	13,5	23,5	41	1,7	11	GWB4099, ES2258, PVL350, V600, DV1300	Yes	100	8

t = palm thickness, s = strip length

03



Fork terminals 0.25 - 10 mm²

• Material: Cu 99.95%, tin plated Cu/Sn, brazed neck.

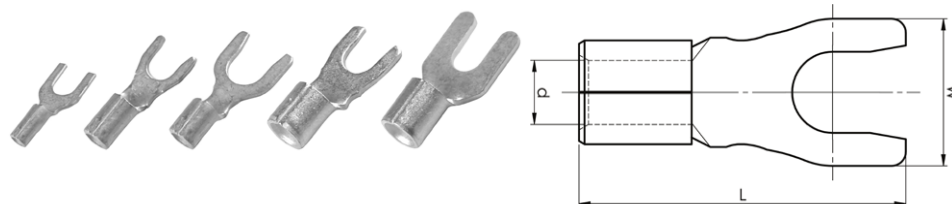

mm ² (Cu)	AWG Cu	Name	Screw	W mm	d	L	t	s	Neck type	Tool	Pcs/ pack
0,25-0,75	24-20	B0832G	M3	5,5	1,3	13	0,5	7	Brazed	DKB0325	100
0,25-0,75	24-20	B0843G	M4	6,2	1,3	16,2	0,5	7	Brazed	DKB0325	100
0,75-1,5	20-16	B1532G	M3	5,5	1,8	14	0,7	7	Brazed	DKB0325, DKB0760	100
0,75-1,5	20-16	B1537GS	M3,5	5,5	1,8	16,2	0,7	7	Brazed	DKB0325, DKB0760	100
0,75-1,5	20-16	B1543G	M4	7	1,8	16,2	0,7	7	Brazed	DKB0325, DKB0760	100
0,75-1,5	20-16	B1553G	M5	9	1,8	18	0,7	7	Brazed	DKB0325, DKB0760	100
1,5-2,5	16-14	B2532G	M3	5,5	2,4	13	0,8	8	Brazed	DKB0325, DKB0760	100
1,5-2,5	16-14	B2543G	M4	7	2,4	16,2	0,8	8	Brazed	DKB0325, DKB0760	100
1,5-2,5	16-14	B2553G	M5	9	2,4	18	0,8	8	Brazed	DKB0325, DKB0760	100
4-6	12-10	B4643G	M4	7,8	3,4	17,4	1	9	Brazed	DKB0760, GWB4099	100
4-6	12-10	B4653G	M5	9	3,4	18	1	9	Brazed	DKB0760, GWB4099	100
10	8	B9953G	M5	10,5	4,5	24	1,1	11	Brazed	GWB4099	100
10	8	B9965G	M6	10,5	4,5	24	1,1	11	Brazed	GWB4099	100

t = palm thickness, s = strip length

Pin terminals 0.25 - 6 mm²

• Material: Cu 99.95%, tin plated Cu/Sn, brazed neck.

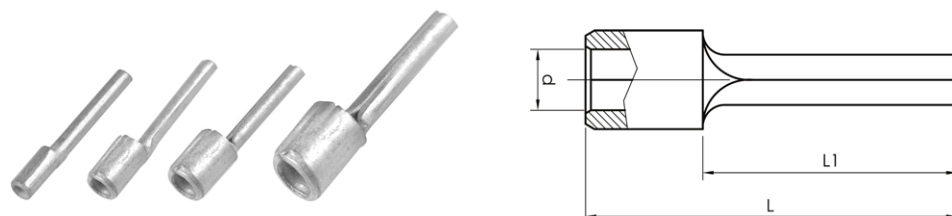

mm ² (Cu)	AWG Cu	Name	W mm	d	L	L1	s	Neck type	Tool	Pcs/ pack
0,25-0,75	24-20	B0819SR	1,8	1,3	17,5	12	7	Brazed	DKB0325	100
0,75-1,5	20-16	B1519SR	1,7	1,8	17	12	7	Brazed	DKB0325, DKB0760	100
1,5-2,5	16-14	B2519SR	1,9	2,4	17	12	8	Brazed	DKB0325, DKB0760	100
4-6	12-10	B4630SR	2,7	3,4	20,8	14	9	Brazed	DKB0760	100

s = strip length

Joining sleeves 0.75 - 10 mm²

- Material: Cu 99.95%, tin plated Cu/Sn.
- UL approved (not KS0,75)



mm ² (Cu)	AWG Cu	Name	d mm	D	L	s	Tool	Pcs/ pack	Die
0,75	(22)-18	KS0,75	1,3	2,8	14	7	DKB0325, DKB0760	100	
1,5	(18)-16	KS1,5	1,8	3,3	14	7	DKB0325, DKB0760	100	
2,5	(16)-14	KS2,5	2,3	4,2	16	8	DKB0325, DKB0760	100	
4	12	KS4	3	5	19	9	GWB4099, ES2258	100	
6	10	KS6	4	6	19	9	GWB4099, ES2258	100	
10	8	KS10	5	8	30	15	GWB4099, ES2258, PVL350, V600, DV1300	100	8

s = strip length



Receptacles rolled type 0.5 - 6 mm²

• Material: brass/Cu, tin plated Cu/Sn.

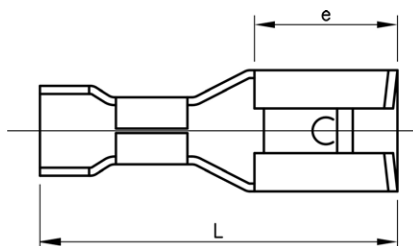

mm ² (Cu)	AWG Cu	Name	e mm	L	t	s	For tab	Tool	Pcs/ pack
0,5-1	20-18	B1003FLS5	6	14	0,25	7	2,8x0,5	DRB0115	100
0,5-1	20-18	B1003FLS8	5	12,7	0,3	7	2,8x0,8	DRB0115	100
0,75-1,5	20-16	B1505FLS5-1	6,4	16	0,4	7	4,8x0,5	GRB0560	100
0,75-1,5	20-16	B1505FLS8-1	6,4	16	0,4	7	4,8x0,8	GRB0560	100
0,75-1,5	20-16	B1507FLS1	7,6	19	0,4	7	6,3x0,8	GRB0560	100
1,5-2,5	16-14	B2505FLS5	6	15,6	0,35	8	4,8x0,5	GRB0560	100
1,5-2,5	16-14	B2505FLS8	6	16	0,4	8	4,8x0,8	GRB0560	100
1,5-2,5	16-14	B2507FLS1	7,6	19	0,4	8	6,3x0,8	GRB0560	100
4-6	12-10	B4607FLS1	7,6	19	0,4	8	6,3x0,8	GRB0560	100

t = metal thickness, s = strip length

Receptacles with locking lip rolled type 0.5 - 6 mm²

• Material: brass/Cu, tin plated Cu/Sn.

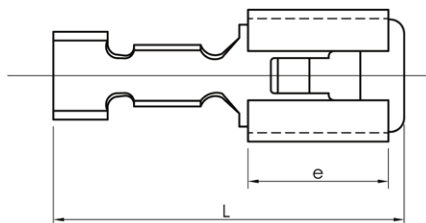

mm ² (Cu)	AWG Cu	Name	t mm	e	L	s	For tab	Tool	Pcs/ pack
0,5-1,5	20-16	B1507FLSN	0,4	7,5	19,2	7	6,3x0,8	GRB0560	100
1,5-2,5	16-14	B2507FLSN	0,4	7,5	19	8	6,3x0,8	GRB0560	100
4-6	12-10	B4607FLSN	0,4	7,5	19	9	6,3x0,8	GRB0560	100

t = metal thickness, s = strip length



Multiple tabs, rolled type (piggy back) 0.5 - 2.5 mm²

• Material: brass/Cu, tin plated Cu/Sn.

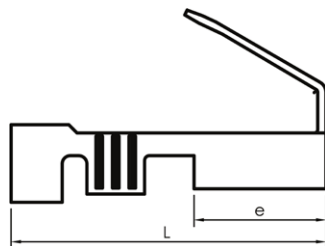

mm ² (Cu)	AWG Cu	Name	t mm	e	L	s	For tab	Tool	Pcs/pack
0,5-1,5	20-16	B1507FLSH	0,4	8	20	7	6,3x0,8	GRB0560	100
1,5-2,5	16-14	B2507FLSH	0,4	8	20	7	6,3x0,8	GRB0560	100

t = metal thickness, s = strip length

Receptacles 90° rolled type 0.5 - 1.5 mm²

• Material: brass/Cu, tin plated Cu/Sn.

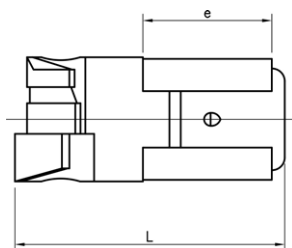

mm ² (Cu)	AWG Cu	Name	t mm	e	L	s	For tab	Tool	Pcs/pack
0,5-1,5	20-16	B1507FLSB8	0,4	7,7	13	7	6,3x0,8	TRB0515B	100

t = metal thickness, s = strip length

Receptacle angled rolled type 0.5 - 1 mm²

• Material: brass/Cu, tin plated Cu/Sn.

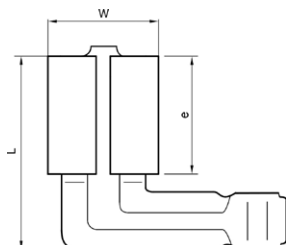

mm ² (Cu)	AWG (Cu)	Name	W mm	t	e	L	s	For tab	Tool	Pcs/pack
0,5-1	20-18	B1003FLSV5	3,8	0,3	4,9	9,3	7	2,8x0,5	DRB0115	100

t = metal thickness, s = strip length

03

Tab 0.5 - 2.5 mm²

• Material: brass/Cu, tin plated Cu/Sn.

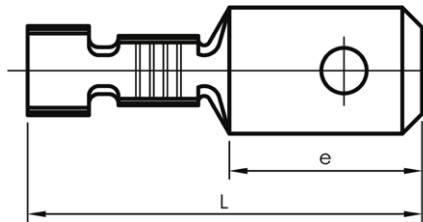

mm ² (Cu)	AWG Cu	Name	e mm	L	s	For tab	Tool	Pcs/pack
0,5-1	20-18	B1003H	5,6	12,7	7	2,8x0,8	DRB0115	100
0,5-1,5	20-16	B1507H	8	19	7	6,3x0,8	GRB0560	100
1,5-2,5	16-14	B2507H	8	20	8	6,3x0,8	GRB0560	100

s = strip length

Tab with locking lip 0.5 - 6 mm²

• Material: brass/Cu, tin plated Cu/Sn.

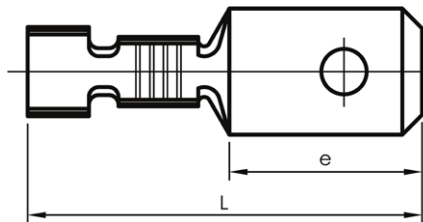
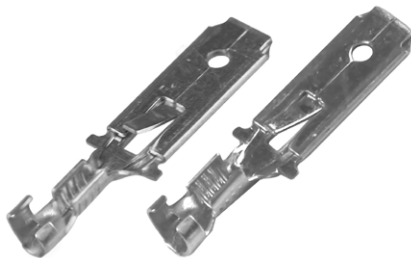

mm ² (Cu)	AWG Cu	Name	e mm	L	s	For tab	Tool	Pcs/pack
0,5-1,0	20-18	B1007HN	16	28	8	6,3x0,8	DRB0115	100
1,5-2,5	16-14	B2507HN	16	28	8	6,3x0,8	GRB0560	100
4-6	12-10	B4607HN	16	28	9	6,3x0,8	GRB0560	100

s = strip length

Bullet and Socket 0.2 - 1.5 mm²

• Material: brass/Cu, tin plated Cu/Sn.

• HA = Male contact

• HO = Female contact

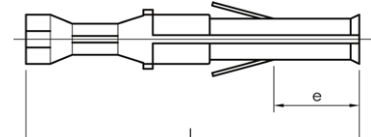
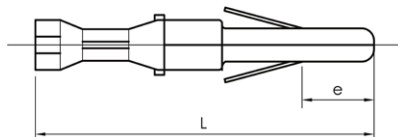

mm ² (Cu)	AWG Cu	Name	e mm	L	s	For bullets ∅	Tool	Pcs/pack
0,2-0,5	24-20	B0502HA	5,5	21	7	2	DRB0115	100
0,5-1,5	20-16	B1502HA	5,5	21	8	2	DRB0115	100
0,2-0,5	24-20	B0502HO	5,5	21	7		DRB0115	100
0,5-1,5	20-16	B1502HO	5,5	21	8		DRB0115	100

s = strip length



Tab with one male

• Material: brass/Cu, tin plated Cu/Sn.

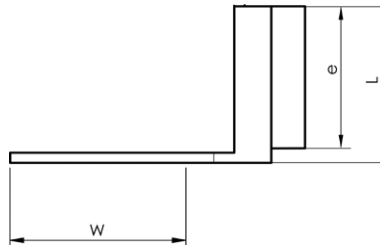

Name	W mm	e	L	Tab	Pcs/pack
B07FLS1H	8,5	8	8,5	6,3x0,8	100

Tab with 2 males

• Material: brass/Cu, tin plated Cu/Sn.

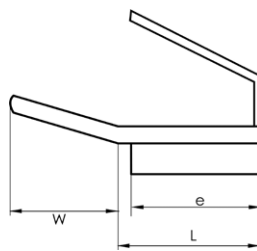

AWG Cu	Name	W mm	e	L	Tab	Pcs/pack
2/0	B07FLS2H	9	7,5	18,5	6,3x0,8	100

Tab with 3 males

• Material: brass/Cu, tin plated Cu/Sn.

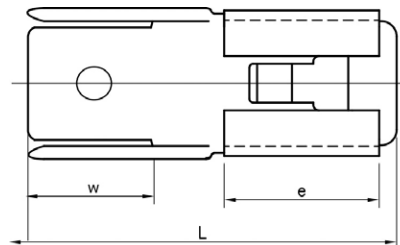

Name	W mm	e	L	Tab	Pcs/pack
B07FLS3H	8	7,5	21	6,3x0,8	100

Tab connector

• Material: brass/Cu, tin plated Cu/Sn.

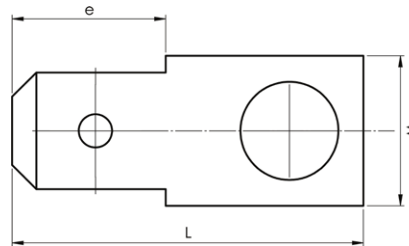

Name	W mm	e	∅	L	Tab	Pcs/pack
B1807H4	8,1	8,3	4,4	19,1	6,3x0,8	100
B1807H5	8	8,3	5,4	19,2	6,3x0,8	100

∅ = Hole diameter

Tab connector 45°

• Material: brass/Cu, tin plated Cu/Sn.

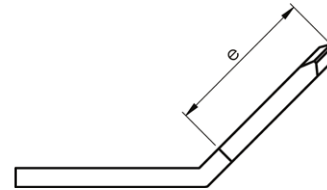
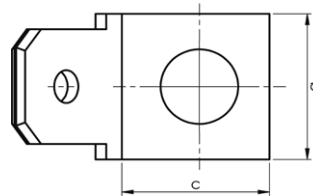

Name	b mm	c	e	∅	Tab	Angle °	Pcs/pack
B0457H4	8	8	8	4,1	6,3x0,8	45°	100
B0457H5	8	8	8	5,3	6,3x0,8	45°	100

∅ = Hole diameter

Tab connector 90°

• Material: brass/Cu, tin plated Cu/Sn.

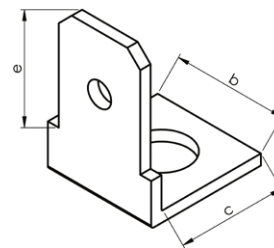
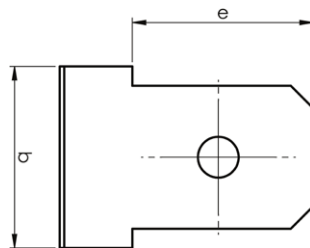

Name	Bb mm	c	e	∅	Tab	Angle °	Pcs/pack
B0907H4	8	8	8,3	4,1	6,3x0,8	90°	100
B0907H5	8	8	8	5,3	6,3x0,8	90°	100

∅ = Hole diameter



Tab connector 2 x 45°

• Material: brass, tin plated Cu/Sn



CE

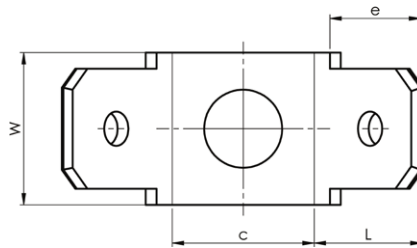

Name	W mm	c	e	φ	L	Tab	Angle °	Pcs/pack
B2457H4	10	12	8	4,2	10	6,3x0,8	2x45°	100
B2457H5	10	12	8	5,2	10	6,3x0,8	2x45°	100

∅ = Hole diameter

Tab for soldering with 2 solder pins

• Material: brass/Cu, tin plated Cu/Sn.



CE

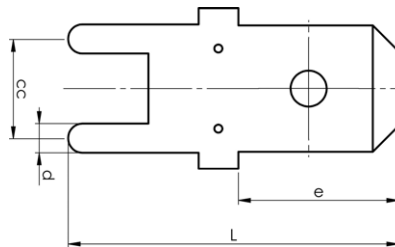

Name	d mm	cc	e	L	Tab	rec. Drill	Pcs/pack
12523	1,5	5	8	16,8	6,3x0,8	1,45	100

Tab for soldering with 2 solder pins, 90°

• Material: brass/Cu, tin plated Cu/Sn.



CE

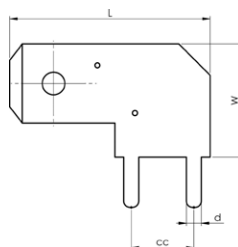

Name	W mm	d	cc	L	Tab	rec. Drill	Pcs/pack
17127	5	1,3	5	13,4	2,8x0,8	1,30	100
17128	9	1,2	5	16	6,3x0,8	1,30	100

Tab for soldering with 1 solder pin

• Material: brass/Cu, tin plated Cu/Sn.

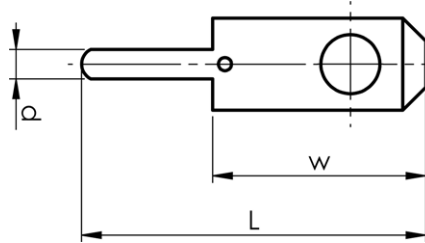

Name	W mm	d	L	Tab	rec. Drill	Pcs/pack
12610	6,5	0,9	10,5	2,8x0,8	1,0	100



Insulation boot ISO1003FL1

• Used in conjunction with straight tab connections.

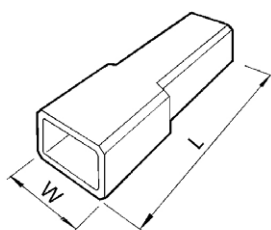
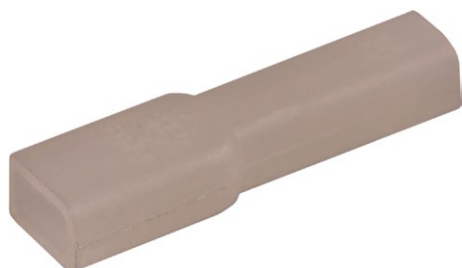

Name	W mm	L	For tab	Temp, °C (Min - Max)	Max ϕ conductor	Pcs/pack	Insulation material
ISO1003FL1	5,5	19	2,8	-50 +85	2,5	100	PE

Insulation boot ISO1005FL1

• Used in conjunction with straight tab connections.

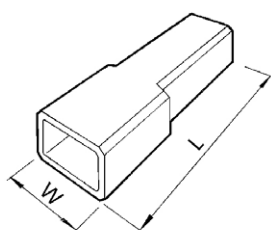
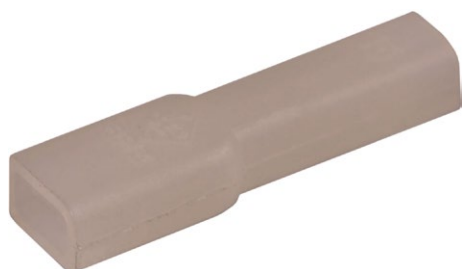

Name	W mm	L	For tab	Temp, °C (Min - Max)	Max ϕ conductor	Pcs/pack	Insulation material
ISO1005FL1	7,6	21	4,8	-25 +75	3,2	100	PVC

Insulation boot ISO1507H-BW6

• Used in conjunction with straight tab connections.

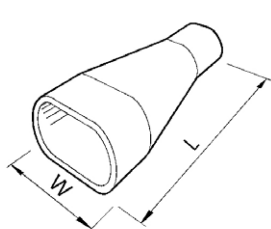

Name	W mm	L	For tab	Temp, °C (Min - Max)	Max ϕ conductor	Pcs/pack	Insulation material
ISO1507HBW6	11	23	6,3	-25 +75	3,6	100	PVC

Insulation boot ISO1507FLS

• Used in conjunction with straight tab connections.

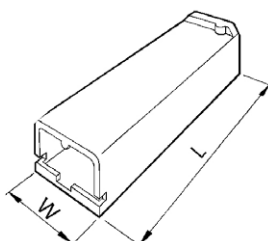

Name	W mm	L	For tab	Temp, °C (Min - Max)	Max ø conductor	Pcs/pack	Insulation material
ISO1507FLS	9	24,4	6,3	-25 +90	3,2	100	PP

Insulation boot ISO2507FLS1

• Used in conjunction with straight tab connections.

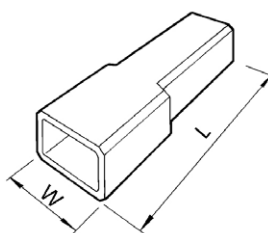

Name	W mm	L	For tab	Temp, °C (Min - Max)	Max ø conductor	Pcs/pack	Insulation material
ISO2507FLS1	9,5	22,5	6,3	-50 +85	3,0	100	PE

Insulation boot ISO1507FLB

• Used with angled tab connector 90°.

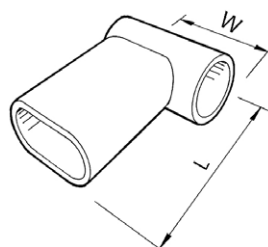

Name	W mm	L	For tab	Temp, °C (Min - Max)	Max ø conductor	Pcs/pack	Insulation material
ISO1507FLB	15	17,3	6,3	-25 +75	2,5	100	PVC

Connector block for receptacles 1.5 - 6 mm²

- Used with receptacles and tabs 1.5-6 mm² with locking lip.
- Material nylon transparent.
- Max voltage 250 V.

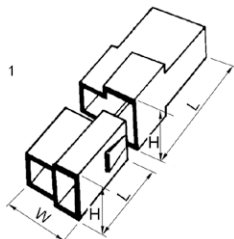

Name	Pole	W mm	H	L	Pcs/pack	Used with
408-2-M	2	16,4	9,7	24	100	B2507FLSN, B4607FLSN
408-4-M	4	28	15,3	24	100	B2507FLSN, B4607FLSN
408-6-M	6	29	15,2	29	100	B2507FLSN, B4607FLSN
408-8-M	8	38	15,6	34	100	B2507FLSN, B4607FLSN
408-2-F	2	20	12,7	32	100	B2507HN, B4607HN
408-4-F	4	23	17,4	33	100	B2507HN, B4607HN
408-6-F	6	31	18,7	33	50	B2507HN, B4607HN
408-8-F	8	40	18,6	33	25	B2507HN, B4607HN

Connector block for bullets and sockets 0.2 - 1.5 mm²

- Used with sockets and bullets 0.2-1.5 mm².
- Material polyamide transparent.
- Max voltage 250 V.
- Max current 20 A.
- Temperature range -20°C to +105°C.
- Tested against breakthrough for 1 min at 1500 V AC.

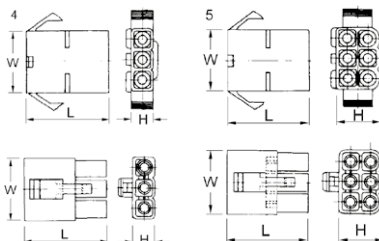
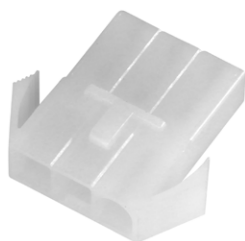

Name	Pole	W mm	H	L	Pcs/pack	Used with
MC02F	2	13,6	7,3	27	100	B0502HA, B1502HA
MC02M	2	13,5	7,3	27	100	B0502HO, B1502HO
MC03F	3	19,6	7,2	27	100	B0502HA, B1502HA
MC03M	3	19,6	7,1	27	100	B0502HO, B1502HO
MC04F	4	13,5	13,5	27	100	B0502HA, B1502HA
MC04M	4	13,5	13,5	27	100	B0502HO, B1502HO
MC06F	6	19,6	13,4	27	100	B0502HA, B1502HA
MC06M	6	19,6	13,4	27	100	B0502HO, B1502HO
MC09F	9	19,7	19,7	27	100	B0502HA, B1502HA
MC09M	9	19,7	19,7	27	100	B0502HO, B1502HO
MC12F	12	26	19,6	27	50	B0502HA, B1502HA
MC15F	15	32	19,6	27	50	B0502HA, B1502HA
MC15M	15	32	19,9	26	50	B0502HO, B1502HO



Connector block for receptacles - 400 V /18 A

- Used in conjunction with flat pin sleeves.
- Material PVC transparent.
- Max voltage 400 V.
- Max current 18 A.

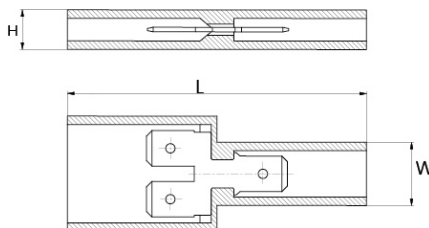
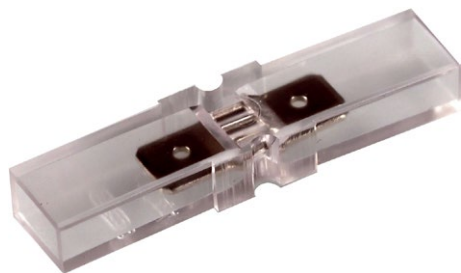

Name	Pole	W mm	H	L	Tab	Pcs/pack
404-1	1	12	6	48	6,3x0,8	100
405-3	1+2	20,7	7,4	54,5	6,3x0,8	100
401-12	12	28	7	147	6,3x0,8	50

Assortment box - uninsulated terminals



PL701



Assortment box designed for electricians in the field and for service workshops.

Properties:

- box made of LDPE/TP
- 19 compartments (+ 10 empty compartments)
- 700 uninsulated terminals and through connectors 0.75-10 mm²
- crimping tool DKB0325
- crimping tool GWB4099 Miniforce
- stripping tool SCT001

mm ²	AWG	Name	Net weight (kg)	Length mm	Width	Height
0,75-10	22-8	PL701	3,426	380	285	55



ELPRESS

Hobby tools for pre-insulated and uninsulated 0.5 - 6 mm² terminals as well as cutting and stripping

Properties:

- made of high-grade steel with semi-soft handles
- crimping positions are clearly marked
- the tools do not have a locking function
- cuts up to and including 6 mm²
- strips up to and including 6 mm²
- cuts screws M2.5-M5



T50 Hobby tool

Special properties:

- contact crimps pre-insulated 0.5 - 6 mm² terminals and tab crimps uninsulated 1.5 - 6 mm² terminals
- red handle

Crimp geometries

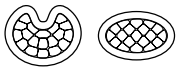

mm ²	AWG	Name	Crimp geometries	Net weight (kg)	Length mm
0,5-6	20-10	T50	Tab, Oval	0,268	225



T51 Hobby tool

Special properties:

- contact crimps pre-insulated 0.5 - 6 mm² terminals and roll crimps uninsulated 0.5 - 2.5 mm² terminals
- yellow handle

Crimp geometries



mm ²	AWG	Name	Crimp geometries	Net weight (kg)	Length mm
0,5-6	20-10	T51	Oval, Roll	0,268	225

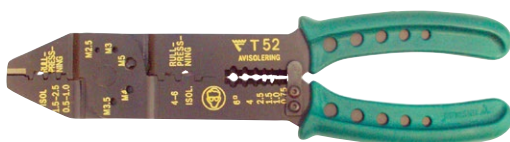

T52 Hobby tool

Special properties:

- roll crimps uninsulated 0.5 - 6 mm² terminals
- green handle

Crimp geometry



mm ²	AWG	Name	Crimp geometry	Net weight (kg)	Length mm
0,5-6	20-10	T52	Roll	0,268	225

Tool for uninsulated terminals 0.15 - 6 mm² with measuring certificate



Properties:

- crimp points are clearly marked
- adjustable for changes after long use
- tested with Elpress terminals according to requirements of SEN and DIN
- locking function that ensures a complete crimp
- emergency release if the crimping process has to be interrupted
- unique design that makes the tools thin and versatile
- minimal muscle strength required for complete crimp
- withstands at least 50,000 crimps
- supplied with certificate for basic quality monitoring



TRB0515B



Crimping tool for Roller crimping terminals B1507FLSB8.

- No measuring certificate

Crimp geometry



mm ²	AWG	Name	Crimp geometry	Net weight (kg)	Length mm	Width	Height
0,5-1,5	20-16	TRB0515B	Roll	0,74	275	135	49



DRB0115



Tested and certified mechanical hand tool for roll crimping uninsulated tab, bullet and socket terminals 0.15-1.5 mm². GRB0560 is used to crimp B1507FLS1, B1507FLSH

Crimp geometry



mm ²	AWG	Name	Crimp geometry	Net weight (kg)	Length mm	Width
0,15-1,5	26-16	DRB0115	Roll	0,452	192	66



DKB0325



Tested and certified mechanical hand tool for indent crimping Cu terminals 0.25-2.5 mm².

Crimp geometry



mm ²	AWG	Name	Crimp geometry	Net weight (kg)	Length mm	Width
0,25-2,5	24-14	DKB0325	Tab	0,444	192	66



ELPRESS



DKB0760



Tested and certified mechanical hand tool for indent crimping Cu terminals 0.75-6 mm².

mm ²	AWG	Name	Crimp geometry	Net weight (kg)	Length mm	Width
0,75-6	20-10	DKB0760	Tab	0,445	192	66

Crimp geometry



Miniforce tool for uninsulated terminals 0.5 - 10 mm² with measuring certificate



- **Properties:**
 - locking function which only releases once crimping is complete
 - emergency release if the crimping process has to be interrupted
 - clearly marked crimping positions
 - adjustable for changes after long use
 - tested with Elpress terminals
 - unique mechanism that reduces maximum handle force from 450 N right down to 250 N (model C)
 - ergonomic handle suitable for all users
 - maximises the quality of work
 - reduces the risk of occupational injuries
 - light and versatile design without sacrificing on strength
 - model C has extra long handles for the use of two hands
 - withstands at least 80,000 crimps
- supplied with certificate for basic quality monitoring



GRB0560L and GRB0560LC

Tested and certified mechanical Miniforce hand tool for roll crimping uninsulated terminals 0.5-6 mm². The tool is type L equipped with three interchangeable locators for different types of terminals (see table). Type LC has long handles.

Special properties:

- delivered in practical plastic box
- locator that holds the terminal in the correct position when crimping and gives you an "extra hand" that facilitates work in, for example, confined spaces



Crimp geometry

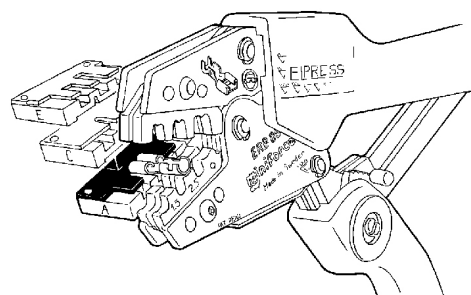

GRB0560-locator

mm ²	AWG	Name	Crimp geometry	Net weight (kg)	Length mm	Width
0,5-6	20-10	GRB0560L	Roll	0,935	203	76
0,5-6	20-10	GRB0560LC	Roll	0,994	256	80

Locator	Marking	
A	1.	B1507FLS1 B1507FLSN
	2.	B2507FLS1 B2507FLSN
	3.	B4607FLSN B4607FLS1
C	1.	B1507H
	2.	B2507HN
	3.	B4607HN
E	1.	B1505FLS (5 el 8) -1
	2.	B2505FLS (5 el 8) -1





GRB0560 and GRB0560C



Tested and certified mechanical Miniforce hand tool for roll crimping uninsulated terminals 0.5-6 mm².

mm ²	AWG	Name	Crimp geometry	Net weight (kg)	Length mm	Width
0,5-6	20-10	GRB0560	Roll	0,555	203	76
0,5-6	20-10	GRB0560C	Roll	0,615	256	80

Crimp geometry



03



GWB4099 and GWB4099C



Tested and certified mechanical Miniforce hand tool for W crimping uninsulated ring, fork and pin terminals as well as tube terminals and through connectors type KR and KS 4-10 mm².

mm ²	AWG	Name	Crimp geometry	Net weight (kg)	Length mm	Width
4-10	12-8	GWB4099	W	0,542	203	76
4-10	12-8	GWB4099C	W	0,56	256	80

Crimp geometry



GWB4010 and GWB4010C



Tested and certified mechanical Miniforce hand tool for W crimping un-insulated ring, fork and pin terminals as well as tube terminals and through connectors type KR/KRT and KS/KST 4-10 mm².

mm ²	AWG	Name	Crimp geometry	Net weight (kg)	Length mm	Width
4-10	12-8	GWB4010	W	0,543	256	80
4-10	12-8	GWB4010C	W	0,595	256	80

Crimp geometry



Battery-powered crimping tools for pre-insulated 0.5 - 6 mm² terminals, uninsulated 0.25 - 10 mm² terminals and 0.5 - 50 mm² end sleeves

Properties:

- Li-ion battery powered (10.8 V and 2 Ah), charging time about 40 min
- very good accessibility and ergonomics
- service and installation tools
- fast crimping process 2 – 4 sec
- approximately 230 crimps/battery charge
- dies for the tool sold separately



PVL130P - Elpress Mini

Elpress mini tool with a sleek design with a high performance Li-Ion battery that facilitates your work with its improved battery capacity. Crimping force max. 13 kN. 1 x Li-ion battery and charger included.

Properties:

- one-handed operation for easy control of all tool functions
- durable crimping head for long service life
- optimal crimping thanks to parallel-moving dies
- easy to use due to its low weight
- high-performance 12 V Li-Ion battery – with indication of charge status
- open head, rotating
- easy and comfortable to use one handed thanks to its ergonomic 2-component housing with grip-friendly protection
- automatic return of dies when crimping is complete



PVL130P - Elpress MINI, dies sold separately.

mm ² (Cu)	AWG (Cu)	Name	Net weight (kg)	Length	Width	Height	Note
0,25-50	24-1/0	PVL130P	1,5	330	85	60	Charger: 230VAC
0,25-50	24-1/0	PVL130P-US	1,5	330	85	60	Charger: 115VAC
0,25-50	24-1/0	PVL130P-WOBC	0,91	330	85	60	without Battery/Charger



PVL130P, case and charger.





PVL130S - Elpress Mini



PVL130S - Elpress MINI, supplied with die pair SA0760.

Elpress mini tools with intuitive PowerSense function combine the benefits of manual crimping tools with the benefits of battery-powered hydraulic crimping tools.

Crimping force max. 15 kN. 1 x Li-ion battery and charger included.

Properties:

- one-handed operation for easy control of all tool functions
- electronic control with locking function and monitoring for complete closure of the jaws
- safety loop used as fall protection when used outdoors
- motor protection ensures safety in case of overload
- easy and comfortable to use one handed thanks to its ergonomic 2-component housing with grip-friendly protection
- very low weight and fast crimping process for maximum efficiency
- powerful driving technology allows for easy crimps
- high-performance 12 V Li-Ion battery – with indication of charge status
- LED work lighting
- Die pair SA0760 comes with the tool

mm ² (Cu)	AWG (Cu)	Name	Net weight (kg)	Length	Width	Height	Note
0,25-50	24-1/0	PVL130S	1,5	58	92	250	Charger: 230VAC
0,25-50	24-1/0	PVL130S-US	1,5	58	92	250	Charger: 115VAC
0,25-50	24-1/0	PVL130S-WOBC	0,91	58	92	250	without Battery/Charger



Dies for PVL130P/PVL130S



EB0560



WB4099



KB0325



EB3550



EB1025



EB4010



RB0560



SA0760

mm ² (Cu)	AWG (Cu)	Name	Crimp geometry	Net weight (kg)	Application
0,5-6	20-10	SA0760	Oval	0,05	Pre-insulated terminals
0,25-2,5	22-14	KB0325	Tab	0,039	Uninsulated terminals
4-10	12-8	WB4099	W	0,05	Uninsulated terminals
0,5-6	20-10	RB0560	Roll	0,05	Uninsulated terminals
0,5-6	20-10	EB0560	Trapezoid	0,057	End sleeves
4-10	12-8	EB4010	Trapezoid	0,05	End sleeves
10-25	6-4	EB1025	Trapezoid	0,05	End sleeves
35-50	2-0	EB3550	Trapezoid	0,05	End sleeves



Elpress Mobile - tool with interchangeable dies

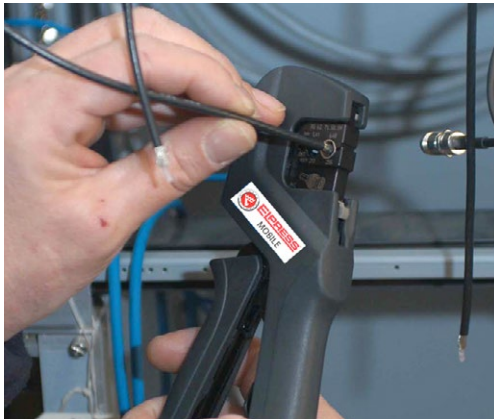

Professional contact crimping tool with interchangeable dies for the installer or service technician.

Properties:

- reliable, safe, economic and ergonomic tools
- parallel-moving crimping movement with 10 kN crimping force, tested for 20,000 crimps
- change crimping dies quickly and easily in one operation
- the crimping dies are kept together in pairs and stored in custom holders
- wide selection of dies allows you to use one tool frame for 19 different crimping applications!



Elpress Mobile, frame only.

Elpress Mobile

Mobile hand tool (frame only). Dies are supplementary.

mm ²	AWG	Name	Net weight (kg)	Length mm	Width
0,25-10	24-8	MOBILE	0,554	234	64



Elpress Mobile + dies OAA0525 and OEB0210.

Mobile Installation

Mobile hand tool with two interchangeable dies:

- Die OAA0525 for crimping pre-insulated 0.5 - 2.5 mm² terminals.
- Die OEB0210 for crimping end sleeves 0.25 - 10 mm².
- The tool comes with associated dies in blister packaging.

Name	Net weight (kg)	Length mm	Width
MOBILE INSTALLATION	0,695	234	64



Elpress Mobile + dies OMP45 and OCC1113.

Mobile DataCom

Mobile hand tool with two interchangeable dies:

- OMP45 for crimping modular plug RJ45.
- OCC1113 for crimping coaxial contacts RG58, RG59, RG62 and RG71.
- The tool comes with associated dies in blister packaging.

Name	Net weight (kg)	Length mm	Width
MOBILE DATA/COM	0,667	234	64



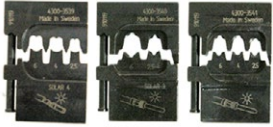

Epress Mobile + dies OMS4, OMS3 and OMSL.



Cable stripper LOKE.

Mobile Solar Kit

Mobile hand tool with three interchangeable dies and cable stripper LOKE for stripping solar panel cable with extra thick insulation:

- OMS4, roll crimping of contacts with sleeve \varnothing 4 mm, 2.5 - 6.0 mm².
- OMS3, square crimping of contacts with sleeve \varnothing 3 mm, 2.5 - 6.0 mm².
- OMSL, square crimping of contacts, 2.5 - 6.0 mm².

Name	Net weight (kg)	Length mm	Width
MOBILE SOLAR	0,772	234	64



Mobile Box

Box for the mobile tool with room for the tool as well as 5-6 associated dies. Tools and dies are ordered separately.

Name	Net weight (kg)	Length mm	Width	Height
MOBILE BOX	0,32	246	218	57



Additional dies for Elpress Mobile

All dies have the same quick and easy way of being inserted into the tool frame. The dies are kept together in pairs and supplied in a cassette that can be docked to other cassettes.



OAA0160
Crimping die for Elpress MOBILE tool for asymmetric crimping of pre-insulated terminals 0.1-4 mm² and 4-6 mm².
AWG 11-9.



OAA0525
Crimping die for Elpress MOBILE tool for asymmetric crimping of pre-insulated terminals 0.5-2.5 mm².
AWG 20-13.



OSW0360
Crimping die for Elpress MOBILE tool for crimping through connectors with heat shrink insulation 0.3-0.75 mm² and 4-6 mm².
AWG 11-9.



OSW0525
Crimping die for Elpress MOBILE tool for crimping through connectors with heat shrink insulation 0.5-1.5 mm² and 1.5-2.5 mm².
AWG 15-13.



OPB0140
Crimping die for Elpress MOBILE tool for crimping global power connectors, GPC connectors.



OPB6099
Crimping die for Elpress MOBILE tool for crimping global power connectors, GPC connectors.



OWB4099
Crimping die for Elpress MOBILE tool for W crimping of uninsulated terminals 4-10 mm².
AWG 11-7.



OKB0725
Crimping die for Elpress MOBILE tool for punch crimping uninsulated terminals 0.75-2.5 mm².
AWG 18-13.



OKB0560
Crimping die for Elpress MOBILE tool for punch crimping uninsulated terminals 0.5-6 mm².
AWG 20-9.



OEB0210
Crimping die for Elpress MOBILE tool for crimping end sleeves 0.25-10 mm².
AWG 24-7.



OEB1625
Crimping die for Elpress MOBILE tool for crimping end sleeves 16-25 mm².
AWG 5-3.



OEB3550
Crimping die for Elpress MOBILE tool for crimping end sleeves 35-50 mm².
AWG 2-1/0.



ORB0110
Crimping die for Elpress MOBILE tool for roll crimping uninsulated terminals 0.1-1 mm².
AWG 26-17.



ORB0560
Crimping die for Elpress MOBILE tool for roll crimping uninsulated terminals 0.5-6 mm².
AWG 20-9.



OMP45
Crimping die for Elpress MOBILE tool for crimping modular plug RJ45.



OMP11
Crimping die for Elpress MOBILE tool for crimping modular plug RJ11.



OFO5432
Crimping die for Elpress MOBILE tool for crimping fibre optic contacts.



OCC0908
Crimping die for Elpress MOBILE tool for crimping coaxial contacts RG174, 179.



OCC1113
Crimping die for Elpress MOBILE tool for crimping coaxial contacts RG58, 59, 62, 71.



OCC4755
Crimping die for Elpress MOBILE tool for crimping coaxial contacts RG6, 59.



OMS4
Dies for Mobile tools for roll crimping contacts with sleeve diameter 4 mm, 2.5-6.0 mm².
AWG 13-19.



OMSL
Die for square crimping contacts 2.5-6.0 mm².
AWG 13-9.



Cu terminals 0.75 - 1000 mm²

General information about Cu terminals.....	2
Tube terminals 0.75 - 10 mm ²	4
KRF tube terminals 16 - 800 mm ²	5
KRF tube terminals with two holes 16 - 400 mm ²	6
KRFS tube terminals with narrow palm 50 - 400 mm ²	7
KRF angled terminals 45° 10 - 150 mm ²	8
KRF angled terminals 90° 10 - 150 mm ²	9
KRT tube terminals 10 - 500 mm ²	10
KRD tube terminals 16 - 1000 mm ²	11
KRD tube terminals 16 - 1000 mm ²	12
DIN 46235 tube terminals 6 - 1000 mm ²	13
DIN 46234 sheet metal terminals 10 - 185 mm ²	14
KS/KSF through connectors 0.75 - 800 mm ²	15
KS/KSF through connectors with partition 10-500 mm ²	16
KST through connectors with partition 10-500 mm ²	17
KSD through connectors with partition 16-1000 mm ²	18
KSxP parallel connectors for conductors total 0.5 - 6.75 mm ²	18
KSxP parallel connectors for conductors total 10 - 630 mm ²	19
CUT through connectors for single strand conductors 6 - 16 mm ²	19
DIN 46230 pin terminals 10 - 95 mm ²	20
KRX tube terminals for Excel and Fxcel cable 10 - 16 mm ²	20
KSX through connectors for Excel and Fxcel cable 10 - 16 mm ²	20
C-sleeves 6 - 300 mm ²	21

General information about Cu terminals



System Elpress

System Elpress consists of terminals and tools that are designed and tested together to give a certified crimping result. This ensures that users will feel confident when using our systems, and that a secure connection is achieved through the proper handling of our products. By using Elpress Cu-connection elements together with one of Elpress crimp systems one obtains a connection that has been tested according to the requirements of IEC 61238:1.



Cu terminals

Elpress copper connectors are made of pure copper 99.95%. We manufacture tube terminals type KR/KRF/KRD/KRT, through connectors type KS/KSF/KSD/KST for stranded conductors, IEC 60228 class 2, and multi-stranded conductors IEC 60228 class 5 such as C-sleeves primarily pre-splicing of Cu-lines and many customised products. For flexible and stranded Cu conductors, terminals of type KR/KRF and through connectors of type KS/KSF are used. Terminals type KRD/KRT and through connectors type KSD/KST are normally used for stranded Cu conductors from and including 500 mm². Terminals of type KR/KRF/KRD/KRT are used mainly in termination to bus bars and apparatus of copper, while through connectors, of type KS/KSF/KSD/KST, are used mainly in the splicing of copper conductors in cable assemblies. They can also be used for straight splicing of earth conductors. With a branching sleeve, type C, one splices and branches earth conductors, lightning conductor installations and the like.



UL-approved terminals

KR/KS, KRF/KSF, KRFS, KRFN, KRT/KST
UL approved in accordance with file no. E205350.



DNV-approved terminals

Elpress KR/KS, KRF/KSF and KRT/KST terminals meet DNV's rules for classification of ships and Det Norske Veritas' Offshore Standards. The terminals are approved for installations on ships and mobile "offshore" units.

Number of crimps

Normally one crimp is required up to and including 150 mm² and two or three crimps for larger areas. Note, however, that another number of crimps may be needed in some cases, see tables for tool dies. If possible, crimps should be placed next to each other with a couple of mm spacing between each one. Overlap is sometimes inevitable.

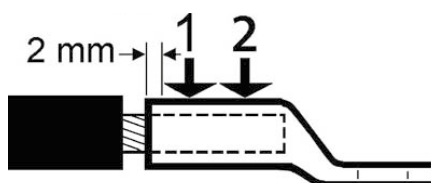

Crimp sequence for two crimps.

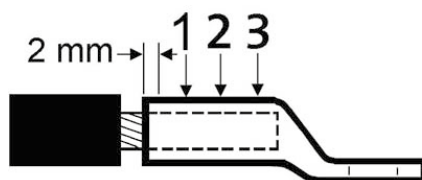

Crimp sequence for three crimps.

Marking of Cu terminals

Elpress marking system for copper terminals shows logotype, cable area and type number for hexagonal die. This system allows checks that the correct tools have been used when contact crimping because the die number automatically becomes embossed during the contact crimping.



Marking tube terminals

25 (on neck)
Type No. for hexagonal die (Elpress logo) 150 12 F (on the palm)
150 = Cu conductor in mm²
12 = Hole size
F = KRF



Marking through connectors

Elpress Logo
Type No. for hexagonal die
16 F (possible screened conductor area and earthing sign)
16 = Cu conductor in mm²
F = KSF



Marking C-sleeves (example C70-95)

Area marking (side 1)
25-120 / 140-190
min - max (mm² per conductor) / min - max (total mm² in the sleeve)
Elpress logo, Die number (side 2)
BCx, "x" corresponds to die number

Clearance for holes in terminal palm

Screw size	Hole diameter (Ø mm)
M3	3,2
M4	4,3
M5	5,3
M6	6,4
M8	8,4
M10	10,5
M12	13
M16	17
M20	21
M24	26

Screw and washer

The following apply for bright galvanized type nuts and screws, with strength class 8.8, used for connecting terminals with Cu and Al palms:

- Always use a torque wrench to be certain the right torque is achieved. Make sure it is calibrated at regular intervals according to the supplier's instructions.
- Use the recommended torque according to the screw manufacturer's instructions.
- Always use a hard plain washer to reduce friction against the connection surface and the edge pressure, hardness min HB200.
- Install as illustrated.

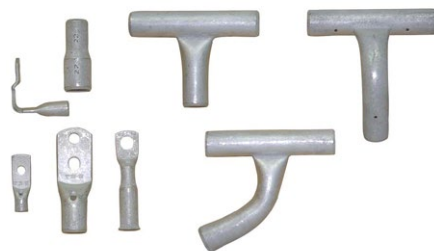
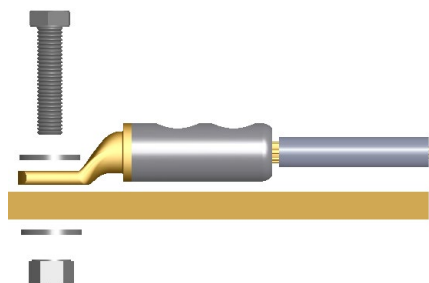

Customised products

Customised products are an important part of our work. Solving problems for the customer and at the same time manufacturing the products with profitability is a special challenge. This way, we also increase our knowledge of the customers' needs. The above terminals include different models of T-connectors where you can connect three conductors of the same size using only one terminal. These are used, for example, in transformer manufacturing. Other connections in transformer manufacturing are lead-in pins and special terminals for switches. In conclusion, all terminals are designed to easily ensure a high-quality connection even in advanced applications.

Tube terminals 0.75 - 10 mm²

- Material: Cu 99.95%, tin plated Cu/Sn.
- For multi-stranded (class 5) and stranded (class 2) Cu conductors.
- UL approved (1.5 - 10 mm²).



Examples of palm marking KR: 10 10

10 = mm² 10 = Palm hole for M10

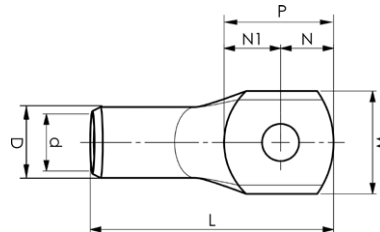

mm ² (Cu)	AWG Cu	Name	Screw	W mm	d	D	N	N1	P	L	t	s	Tool	Inspection hole	Pcs/ pack	Die
0,75	(22)-18	KR0,75-3	M3	6	1,3	2,8	3,2	3,8	7	17	0,85	7,5	DKB0325, DKB0760	No	100	
0,75	(22)-18	KR0,75-4	M4	6	1,3	2,8	3,2	3,5	6,7	17	0,8	7,5	DKB0325, DKB0760	No	100	
1,5	(18)-16	KR1,5-3	M3	6,5	1,8	3,3	3,4	3,6	7	16	1	7,5	DKB0325, DKB0760	No	100	
1,5	(18)-16	KR1,5-4	M4	6,5	1,8	3,3	4,2	3,8	8	17	0,9	7,5	DKB0325, DKB0760	No	100	
1,5	(18)-16	KR1,5-5	M5	7,5	1,8		4,8	4,7	9,5	18	0,85	7,5	DKB0325, DKB0760	No	100	
2,5	(16)-14	KR2,5-3	M3	7,5	2,3		3,5	4,1	7,6	17	1,3	7	DKB0325, DKB0760	No	100	
2,5	(16)-14	KR2,5-4	M4	7,5	2,3		4,2	4,1	8,3	18	1,3	7	DKB0325, DKB0760	No	100	
2,5	(16)-14	KR2,5-5	M5	8,5	2,3		4,8	4,8	9,6	19	1,1	7	DKB0325, DKB0760	No	100	
2,5	(16)-14	KR2,5-6	M6	8,5	2,4		5,1	5,8	10,9	19	1,1	7	DKB0325, DKB0760	No	100	
4	12	KR4-3	M3	8,5	3		4,2	5,8	10	21	1,5	8,5	GWB4099, ES2258	Yes	100	
4	12	KR4-4	M4	8,5	3		4,2	5,8	10	22	1,5	8,5	GWB4099, ES2258	Yes	100	
4	12	KR4-5	M5	9	3		4,8	5,2	10	22	1,5	8,5	GWB4099, ES2258	Yes	100	
4	12	KR4-6	M6	9,9	3		5	7	12	23	1,3	8,5	GWB4099, ES2258	Yes	100	
6	10	KR6-4	M4	9,5	4		4	6	10	22	1,7	8,5	GWB4099, ES2258	Yes	100	
6	10	KR6-5	M5	9,5	4		5	6	11	22	1,7	8,5	GWB4099, ES2258	Yes	100	
6	10	KR6-6	M6	9,9	4		5,5	6,5	12	23	1,6	8,5	GWB4099, ES2258	Yes	100	
6	10	KR6-8	M8	13	4		7	10	17	30	1,2	8,5	GWB4099, ES2258	Yes	100	
10	8	KR10-4	M4	11,5	5	8	6	8	14	29	2,9	11	GWB4099, ES2258, PVL350, V600, DV1300	Yes	100	8
10	8	KR10-5	M5	11,5	5	8	6	7,5	13,5	29	2,9	11	GWB4099, ES2258, PVL350, V600, DV1300	Yes	100	8
10	8	KR10-6	M6	11,5	5	8	6	7,5	13,5	29	3	11	GWB4099, ES2258, PVL350, V600, DV1300	Yes	100	8
10	8	KR10-8	M8	13,5	5	8	7,5	8,5	16	33	2,3	11	GWB4099, ES2258, PVL350, V600, DV1300	Yes	100	8
10	8	KR10-10	M10	16	5	8	8	10	18	34	2	11	GWB4099, ES2258, PVL350, V600, DV1300	Yes	100	8
10	8	KR10-12	M12	18,5	5	8	10	13,5	23,5	41	1,7	11	GWB4099, ES2258, PVL350, V600, DV1300	Yes	100	8

t = palm thickness, s = strip length



KRF tube terminals 16 - 800 mm²

- Material: Cu 99.95%, tin plated Cu/Sn.
- Inspection hole
- For stranded (class 2) and multi-stranded (class 5) Cu conductors
- For multi-stranded Cu conductors Elpress recommends the DUAL system.
- UL approved (KRF16-500 mm²), DNV approved (16-400 mm²).



Example of marking KRF: 17 (neck) Elpress logotype 70 10F (palm)

17 = Die No. 70 = mm² 10 = palm hole for M10 F = type KRF for stranded and flexible conductors.

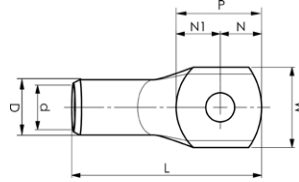

mm ² (Cu)	AWG Cu	Name	Screw	W mm	d	D	N	N1	P	L	t	s	Tool	Pcs/ pack	Die
16	6	KRF16-6	M6	13	6	9	8	9	17	34	2,9	11	PVL350, V600, DV1300, DV250	100	9
16	6	KRF16-8	M8	13	6	9	8	9	17	34	2,9	11	PVL350, V600, DV1300, DV250	100	9
16	6	KRF16-10	M10	16	6	9	10	11	21	38	2,3	11	PVL350, V600, DV1300, DV250	100	9
16	6	KRF16-12	M12	22	6	9	12	13	25	47	1,6	11	PVL350, V600, DV1300, DV250	100	9
25	4	KRF25-6	M6	16	8	11	8	10	18	39	2,9	13	PVL350, V600, DV1300, DV250	100	11
25	4	KRF25-8	M8	16	8	11	8	10	18	39	2,9	13	PVL350, V600, DV1300, DV250	100	11
25	4	KRF25-10	M10	17	8	11	10	11	21	42	2,9	13	PVL350, V600, DV1300, DV250	100	11
25	4	KRF25-12	M12	22	8	11	12	13	25	47	2,1	13	PVL350, V600, DV1300, DV250	100	11
35	2	KRF35-6	M6	18	9	13	10	11	21	47	3,9	16	PVL350, V600, DV1300, DV250	100	13
35	2	KRF35-8	M8	18	9	13	10	11	21	47	3,9	16	PVL350, V600, DV1300, DV250	100	13
35	2	KRF35-10	M10	18	9	13	10	11	21	47	3,9	16	PVL350, V600, DV1300, DV250	100	13
35	2	KRF35-12	M12	22	9	13	12	14	26	52	3,2	16	PVL350, V600, DV1300, DV250	100	13
50	1/0	KRF50-6	M6	21	11	14,5	11	11	22	50	3,4	19	PVL350, V600, DV1300, DV250	100	14,5
50	1/0	KRF50-8	M8	21	11	14,5	11	11	22	50	3,4	19	PVL350, V600, DV1300, DV250	100	14,5
50	1/0	KRF50-10	M10	21	11	14,5	11	11	22	50	3,4	19	PVL350, V600, DV1300, DV250	100	14,5
50	1/0	KRF50-12	M12	21	11	14,5	12	13	25	53	3,4	19	PVL350, V600, DV1300, DV250	100	14,5
50	1/0	KRF50-16	M16	27	11	14,5	15	16	31	59	2,7	19	PVL350, V600, DV1300, DV250	100	14,5
70	2/0	KRF70-6	M6	25	13	17	11	11	22	55	3,9	22	PVL350, V600, DV1300, DV250	50	17
70	2/0	KRF70-8	M8	25	13	17	11	11	22	55	3,9	22	PVL350, V600, DV1300, DV250	50	17
70	2/0	KRF70-10	M10	25	13	17	11	11	22	55	3,9	22	PVL350, V600, DV1300, DV250	50	17
70	2/0	KRF70-12	M12	25	13	17	12	13	25	58	3,9	22	PVL350, V600, DV1300, DV250	50	17
70	2/0	KRF70-16	M16	28	13	17	15	16	31	64	3,5	22	PVL350, V600, DV1300, DV250	50	17
95	4/0	KRF95-8	M8	29	15	20	15	16	31	69	4,9	25	V600, DV1300, DV250	50	20
95	4/0	KRF95-10	M10	29	15	20	15	16	31	69	4,9	25	V600, DV1300, DV250	50	20
95	4/0	KRF95-12	M12	29	15	20	15	16	31	69	4,9	25	V600, DV1300, DV250	50	20
95	4/0	KRF95-16	M16	29	15	20	15	16	31	69	4,9	25	V600, DV1300, DV250	50	20
120	250	KRF120-10	M10	32	17	22	15	16	31	73	4,9	27	V600, DV1300, DV250	25	22
120	250	KRF120-12	M12	32	17	22	15	16	31	73	4,9	27	V600, DV1300, DV250	25	22
120	250	KRF120-16	M16	32	17	22	15	16	31	73	4,9	27	V600, DV1300, DV250	25	22
150	300	KRF150-10	M10	36	19	25	15	16	31	80	5,9	32	V600, DV1300, DV250	25	25
150	300	KRF150-12	M12	36	19	25	15	16	31	80	5,9	32	V600, DV1300, DV250	25	25
150	300	KRF150-16	M16	36	19	25	15	16	31	80	5,9	32	V600, DV1300, DV250	25	25
150	300	KRF150-20	M20	36	19	25	19	19	38	87	5,9	32	V600, DV1300, DV250	25	25
185	350	KRF185-10	M10	39	21	27	15	16	31	86	5,9	37	DV1300, DV250	20	27
185	350	KRF185-12	M12	39	21	27	15	16	31	86	5,9	37	DV1300, DV250	20	27
185	350	KRF185-16	M16	39	21	27	15	16	31	86	5,9	37	DV1300, DV250	20	27
185	350	KRF185-20	M20	39	21	27	19	19	38	93	5,9	37	DV1300, DV250	20	27
240	500	KRF240A-10	M10	42	22,5	30	19	20	39	96	6,4	37	DV1300, DV250	10	30
240	500	KRF240A-12	M12	42	22,5	30	19	20	39	96	6,4	37	DV1300, DV250	10	30
240	500	KRF240A-16	M16	42	22,5	30	19	20	39	96	6,4	37	DV1300, DV250	10	30
240	500	KRF240A-20	M20	42	22,5	30	19	20	39	96	6,4	37	DV1300, DV250	10	30
300	600	KRF300A-10	M10	46	24,5	32	15	19	34	93	6,8	40	DV1300, DV250	10	32
300	600	KRF300A-12	M12	46	24,5	32	15	19	34	93	6,8	40	DV1300, DV250	10	32
300	600	KRF300A-16	M16	46	24,5	32	20	20	40	99	6,8	40	DV1300, DV250	10	32
300	600	KRF300A-20	M20	46	24,5	32	23	25	48	107	6,8	40	DV1300, DV250	10	32
300	600	KRF300A-24	M24	46	24,5	32	23	25	48	110	6,8	40	DV1300, DV250	10	32
400	750	KRF400A-00		56	30	38			55	125	7,8	52	DV1300, DV250	10	38
400	750	KRF400A-12	M12	56	30	38	15	25	40	111	7,8	52	DV1300, DV250	10	38
400	750	KRF400A-16	M16	56	30	38	20	20	40	111	7,8	52	DV1300, DV250	10	38
400	750	KRF400A-20	M20	56	30	38	23	25	48	119	7,8	52	DV1300, DV250	10	38
400	750	KRF400A-24	M24	56	30	38	23	25	48	118	7,8	52	DV1300, DV250	10	38
500	1000	KRF500-00		61	33	42			70	160	8,8	70	DV250, V1470	5	42
500		KRF500-12	M12	61	33	42	25	35	60	150	8,8	70	V250, V1470		42
500		KRF500-14	M14	61	33	42	25	35	60	150	8,8	70	V250, V1470		42
500	1000	KRF500-16	M16	61	33	42	25	35	60	150	8,8	70	DV250, V1470	5	42
500	1000	KRF500-20	M20	61	33	42	25	35	60	150	8,8	70	DV250, V1470	5	42
500	1000	KRF500-24	M24	61	33	42	25	35	60	150	8,8	70	DV250, V1470	5	42
630	1250	KRF630-00		75	39	53			80	195	13,8	80	DV250, V1470	1	53
630	1250	KRF630-12	M12	75	39	53	35	45	80	195	14	80	V250, V1470		53
630		KRF630-16	M16	75	39	53	35	45	80	195	13,8	80	V250, V1470		53
630	1250	KRF630-20	M20	75	39	53	35	45	80	195	13,8	80	DV250, V1470	1	53
630	1250	KRF630-24	M24	75	39	53	35	45	80	195	13,8	80	DV250, V1470	1	53
800	1575	KRF800-00		75	42,5	53			80	195	13,8	80	DV250, V1470	1	53
800		KRF800-16	M16	75	42,5	53	35	45	80	195	13,8	80	V250, V1470		53
800	1575	KRF800-24	M24	75	42,5	53	35	45	80	195	13,8	80	DV250, V1470	1	53

t = palm thickness, s = strip length

KRF tube terminals with two holes 16 - 400 mm²

- Material: Cu 99.95%, tin plated Cu/Sn.
- Inspection hole
- For stranded (class 2) and multi-stranded (class 5) Cu conductors.
- For multi-stranded Cu conductors Elpress recommends the DUAL system.
- UL approved (16-400 mm²), DNV approved (see note).



Example of marking KRF: 17 (neck) Elpress logotype 70 10F (palm)

17 = Die No. 70 = mm² 10 = palm hole for M10 F = type KRF for stranded and flexible conductors.

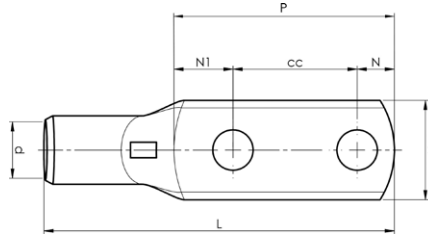

mm ² (Cu)	AWG Cu	Name	Screw	W mm	d	N	N1	P	cc	L	t	s	Tool	Pcs/ pack	Die	Note
16	6	KRF16-6X2-16	M6x2	13	6	6,5	8,5	31	16	50	2,8	11	PVL350, V600, DV1300, V250	100	9	
16	6	KRF16-10X2-40	M10x2	16	6	11	11	62	40	81	2,2	11	PVL350, V600, DV1300, V250	100	9	
16	6	KRF16-10X2-24-26	M10x2	16	6	11	19	55	25	75	2,2	11	PVL350, V600, DV1300, V250	100	9	
25	4	KRF25-6X2-16	M6x2	16	8	6,5	8,5	31	16	54	2,9	13	PVL350, V600, DV1300, V250	100	11	
25	4	KRF25-8X2-40	M8x2	16	8	9,5	10,5	60	40	81	2,8	13	PVL350, V600, DV1300, V250	100	11	
25	4	KRF25-10X2-40	M10x2	18	8	11	19	70	40	93	2,5	14	PVL350, V600, DV1300, V250	100	11	
25	4	KRF25-14X2-40	M14x2	22	8	15	17	72	40	94	1,8	13	DV1300, V250, V600, PVL350	100	11	
35	2	KRF35-10X2-24-26	M10x2	18	9	11	16	52	25	78	3,9	16	PVL350, V600, DV1300, DV250	100	13	
35	2	KRF35-10X2-40	M10x2	20	9	11	19	70	40	95	3,5	16	PVL350, V600, DV1300, DV250	100	13	
50	1/0	KRF50-10X2-24-26	M10x2	21	11	11	16	52	25	82	3,4	19	PVL350, V600, DV1300, DV250	100	14,5	
50	1/0	KRF50-10X2-40	M10x2	21	11	11	19	70	40	100	3,3	19	PVL350, V600, DV1300, DV250	100	14,5	
70	2/0	KRF70-10X2-24-26	M10x2	25	13	11	17	53	25	86	3,9	22	PVL350, V600, DV1300, DV250	50	17	
70	2/0	KRF70-12X2-40	M12x2	25	13	12	18	70	40	103	3,9	22	PVL350, V600, DV1300, DV250	25	17	DNV approved
95	4/0	KRF95-10X2-24-26	M10x2	29	15	11	19	55	25	93	4,9	25	V600, DV1300, DV250	25	20	
95	4/0	KRF95-12X2-40	M12x2	29	15	12	18	70	40	107	4,9	25	V600, DV1300, DV250	25	20	DNV approved
120	250	KRF120-10X2-24-26	M10x2	32	17	11	19	55	25	97	4,9	27	V600, DV1300, DV250	25	22	
120	250	KRF120-12X2-40	M12x2	32	17	12	19	71	40	113	4,9	27	V600, DV1300, DV250	25	22	DNV approved
150	300	KRF150-10X2-24-26	M10x2	36	19	11	19	55	25	104	5,9	32	V600, DV1300, DV250	25	25	
150	300	KRF150-12X2-40	M12x2	36	19	12	19	71	40	120	5,9	32	V600, DV1300, DV250	20	25	DNV approved
185	350	KRF185-10X2-24-26	M10x2	39	21	11	21	57	25	111	5,9	37	DV1300, DV250	20	27	
185	350	KRF185-12X2-40	M12x2	39	21	12	20	72	40	126	5,9	37	DV1300, DV250	20	27	DNV approved
240	500	KRF240A-10X2-24-26	M10x2	42	22,5	11	22	58	25	115	6,4	37	DV1300, DV250	10	30	
240	500	KRF240A-12X2-40	M12x2	42	22,5	12	21	73	40	130	6,4	37	DV1300, DV250	10	30	DNV approved
300	600	KRF300A-12X2-40	M12x2	46	24,5	12	22	74	40	133	6,8	40	DV1300, DV250	5	32	DNV approved
400	750	KRF400A-12X2-40	M12x2	56	30	12	23	75	40	145	7,8	52	DV1300, DV250	1	38	DNV approved

t = palm thickness, s = strip length



KRFS tube terminals with narrow palm 50 - 400 mm²

- Material: Cu 99.95%, tin plated Cu/Sn.
- Inspection hole
- For stranded (class 2) and multi-stranded (class 5) Cu conductors.
- For multi-stranded Cu conductors Elpress recommends the DUAL system.
- Easy to install via cable gland, allows for pre-installation.
- The width of the palm is less than or as wide as the neck.
- UL-approved (95-300 mm²), DNV approved.



Example of marking KRFS: 17 (neck) Elpress logotype 70 10F (palm)

17 = Die no. 70 = mm² 10 = palm hole for M10 F = type KRF for stranded and flexible conductors.

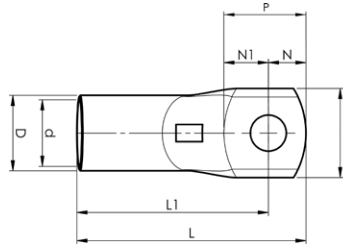

mm ² (Cu)	AWG Cu	Name	Screw	W mm	d	D	N	N1	P	L	L1	t	s	Tool	Pcs/ pack	Die
50	1/0	KRFS50-6	M6	15	11	14,5	11	11,5	22,5	51	40	4	19	PVL350, V600, DV1300, DV250	100	14,5
50	1/0	KRFS50-8	M8	16,5	11	14,5	11	11,5	22,5	51	40	3,8	19	PVL350, V600, DV1300, DV250	100	14,5
50	1/0	KRFS50-10	M10	16,5	11	14,5	11	12,5	23,5	52	41	3,8	19	PVL350, V600, DV1300, DV250	100	14,5
70	2/0	KRFS70-6	M6	17	13	17	11	12,5	23,5	58	47	4,5	22	PVL350, V600, DV1300, DV250	50	17
70	2/0	KRFS70-8	M8	17	13	17	11	12,5	23,5	58	47	4,5	22	PVL350, V600, DV1300, DV250	50	17
70	2/0	KRFS70-10	M10	19	13	17	11	12,5	23,5	58	47	3,9	22	PVL350, V600, DV1300, DV250	50	17
95	4/0	KRFS95-6	M6	19	15	20	11	14	25	63	52	5,7	25	V600, DV1300, DV250	50	20
95	4/0	KRFS95-8	M8	19	15	20	11	14	25	63	52	5,7	25	V600, DV1300, DV250	50	20
95	4/0	KRFS95-10	M10	19	15	20	11	14	25	63	52	5,7	25	V600, DV1300, DV250	50	20
95	4/0	KRFS95-12	M12	20	15	20	12	15	27	64	52	5,4	25	V600, DV1300, DV250	50	20
120	250	KRFS120-6	M6	19	17	22	11	13,5	24,5	67	56	5,9	27	V600, DV1300, DV250	25	22
120	250	KRFS120-8	M8	19	17	22	11	13,5	24,5	67	56	5,9	27	V600, DV1300, DV250	25	22
120	250	KRFS120-10	M10	19	17	22	11	13,5	24,5	67	56	5,9	27	V600, DV1300, DV250	25	22
120	250	KRFS120-12	M12	22	17	22	12	15	27	70	58	5	27	V600, DV1300, DV250	25	22
150	300	KRFS150-6	M6	25	19	25	11	14	25	74	63	6,3	32	V600, DV1300, DV250	25	25
150	300	KRFS150-8	M8	25	19	25	11	14	25	74	63	6,3	32	V600, DV1300, DV250	25	25
150	300	KRFS150-10	M10	25	19	25	11	14	25	74	63	6,3	32	V600, DV1300, DV250	25	25
150	300	KRFS150-12	M12	25	19	25	12	15	27	76	64	6,3	32	V600, DV1300, DV250	25	25
185	350	KRFS185-10	M10	27	21	27	11	13	24	79	68	6,6	37	DV1300, DV250	20	27
185	350	KRFS185-12	M12	27	21	27	12	15	27	82	70	6,6	37	DV1300, DV250	20	27
240	500	KRFS240A-10	M10	29	22,5	29	15	19	34	91	76	7,7	37	DV1300, DV250	10	30
240	500	KRFS240A-12	M12	29	22,5	29	15	19	34	91	76	7,7	37	DV1300, DV250	10	30
240	500	KRFS240A-16	M16	29	22,5	29	20	19	39	96	76	7,7	37	DV1300, DV250	10	30
300	600	KRFS300A-10	M10	31	24,5	31,5	15	19	34	94	79	8,6	40	DV1300, DV250	10	32
300	600	KRFS300A-12	M12	31	24,5	31,5	15	19	34	94	79	8,6	40	DV1300, DV250	10	32
300	600	KRFS300A-16	M16	31	24,5	31,5	20	19	39	99	79	8,6	40	DV1300, DV250	10	32
400	800	KRFS400A-12	M12	38	30	38	15	24	39	114	99	8,8	52	DV1300, DV250	10	38
400	800	KRFS400A-16	M16	38	30	38	20	39	39	114	94	8,8	52	DV1300, DV250	10	38

t = palm thickness, s = strip length



Easy to install via cable gland.

04

KRF angled terminals 45° 10 - 150 mm²

- Material: Cu 99.95%, tin plated Cu/Sn.
- Inspection hole
- For stranded (class 2) and multi-stranded (class 5) Cu conductors.
- For multi-stranded Cu conductors Elpress recommends the DUAL system.
- UL approved (35-150 mm²). DNV approved (16-150 mm²).



Example of marking KRF: 17 (neck) Elpress logotype 70 10F (palm)

17 = Die No. 70 = mm² 10 = palm hole for M10 F = type KRF for stranded and flexible conductors.

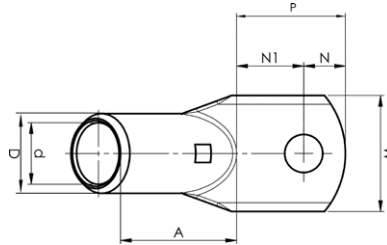

mm ² (Cu)	AWG Cu	Name	Screw	W mm	d	D	N	N1	P	A	t	s	Tool	Pcs/ pack	Die
10	8	KR10-6-45GR	M6	13	5	8	6,5	11,5	20,5	19	2,3	11	PVL350, V600, DV1300, DV250	100	8
10	8	KR10-8-45GR	M8	13,5	5	8	8,5	12	18	19	2,2	11	PVL350, V600, DV1300, DV250	100	8
16	6	KRF16-6-45GR	M6	13	6	9	6,5	11,5	18	23	2,9	12	PVL350, V600, DV1300, DV250	100	9
16	6	KRF16-8-45GR	M8	13	6	9	8,5	12	20,5	23	2,7	12	PVL350, V600, DV1300, DV250	100	9
16	6	KRF16-10-45GR	M10	16	6	9	11,5	13,5	25	23	2,3	12	PVL350, V600, DV1300, DV250	100	9
25	4	KRF25-6-45GR	M6	16	8	11	6,5	11,5	18	24	2,7	13	PVL350, V600, DV1300, DV250	100	11
25	4	KRF25-8-45GR	M8	16	8	11	8,5	12	20,5	24	2,7	13	PVL350, V600, DV1300, DV250	100	11
25	4	KRF25-10-45GR	M10	17	8	11	11,5	13,5	25	23	2,9	13	PVL350, V600, DV1300, DV250	100	11
35	2	KRF35-6-45GR	M6	18	9	13	6,5	11,5	16	30	3,9	16	PVL350, V600, DV1300, DV250	100	13
35	2	KRF35-8-45GR	M8	18	9	13	8,5	12	20,5	30	3,9	16	PVL350, V600, DV1300, DV250	100	13
35	2	KRF35-10-45GR	M10	18	9	13	11,5	13,5	25	30	3,9	16	PVL350, V600, DV1300, DV250	100	13
50	1/0	KRF50-8-45GR	M8	21	11	14,5	8,5	17,5	26	31	3,4	19	PVL350, V600, DV1300, DV250	100	14,5
50	1/0	KRF50-10-45GR	M10	21	11	14,5	11,5	18,5	30	31	3,4	19	PVL350, V600, DV1300, DV250	100	14,5
50	1/0	KRF50-12-45GR	M12	21	11	14,5	12,5	19,5	32	31	3,3	19	PVL350, V600, DV1300, DV250	100	14,5
70	2/0	KRF70-8-45GR	M8	24	13	17	8,5	17,5	26	35	3,9	22	PVL350, V600, DV1300, DV250	50	17
70	2/0	KRF70-10-45GR	M10	24	13	17	11,5	18,5	30	35	3,9	22	PVL350, V600, DV1300, DV250	50	17
70	2/0	KRF70-12-45GR	M12	24	13	17	12,5	19,5	32	35	3,9	22	PVL350, V600, DV1300, DV250	50	17
95	4/0	KRF95-10-45GR	M10	28	15	20	11,5	18,5	30	40	4,9	25	V600, DV1300, DV250	50	20
95	4/0	KRF95-12-45GR	M12	28	15	20	12,5	19,5	32	40	4,9	25	V600, DV1300, DV250	50	20
95	4/0	KRF95-16-45GR	M16	29	15	20	15,5	20,5	36	40	4,8	25	V600, DV1300, DV250	50	20
120	250	KRF120-10-45GR	M10	32	17	22	11,5	18,5	30	43	4,9	27	V600, DV1300, DV250	25	22
120	250	KRF120-12-45GR	M12	32	17	22	12,5	19,5	32	43	4,9	27	V600, DV1300, DV250	25	22
120	250	KRF120-16-45GR	M16	32	17	22	15,5	20,4	35,9	43	4,9	27	V600, DV1300, DV250	25	22
150	300	KRF150-10-45GR	M10	36	19	25	11,5	18,5	30	49	5,8	32	V600, DV1300, DV250	25	25
150	300	KRF150-12-45GR	M12	36	19	25	12,5	19,5	32	49	5,8	32	V600, DV1300, DV250	25	25
150	300	KRF150-16-45GR	M16	36	19	25	15,5	20,5	36	49	5,8	32	V600, DV1300, DV250	25	25

t = palm thickness, s = strip length



KRF angled terminals 90° 10 - 150 mm²

- Material: Cu 99.95%, tin plated Cu/Sn.
- Inspection hole
- For stranded (class 2) and multi-stranded (class 5) Cu conductors.
- For multi-stranded Cu conductors Elpress recommends the DUAL system.
- UL approved (35-150 mm²). DNV approved (16-150 mm²).



Example of marking KRF: 17 (neck) Elpress logotype 70 10F (palm)

17 = Die No. 70 = mm² 10 = palm hole for M10 F = type KRF for stranded and flexible conductors.

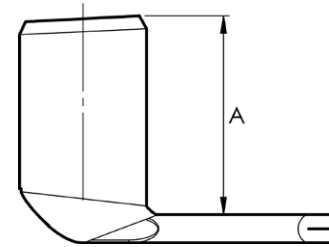
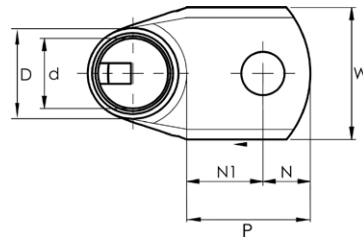

mm ² (Cu)	AWG Cu	Name	Screw	W	d	D	N	N1	P	A	t	s	Tool	Pcs/ pack	Die
10	8	KR10-6-90GR	M6	13	5	8	6,5	11,5	18	15	2,3	11	PVL350, V600, DV1300, DV250	100	8
10	8	KR10-8-90GR	M8	13,5	5	8	8,5	12	20,5	15	2,2	11	PVL350, V600, DV1300, DV250	100	8
16	6	KRF16-6-90GR	M6	13	6	9	6,5	11,5	18	16,5	2,9	12	PVL350, V600, DV1300, DV250	100	9
16	6	KRF16-8-90GR	M8	13	6	9	8,5	12	20,5	16,5	2,7	12	PVL350, V600, DV1300, DV250	100	9
25	4	KRF25-6-90GR	M6	16	8	11	6,5	11,5	18	18,5	2,7	13	PVL350, V600, DV1300, DV250	100	11
25	4	KRF25-8-90GR	M8	16	8	11	8,5	12	20,5	18,5	2,7	13	PVL350, V600, DV1300, DV250	100	11
25	4	KRF25-10-90GR	M10	17	8	11	11,5	13,5	25	18,5	2,9	13	PVL350, V600, DV1300, DV250	100	11
35	2	KRF35-6-90GR	M6	18	9	13	6,5	11,5	18	22,5	3,9	16	PVL350, V600, DV1300, DV250	100	13
35	2	KRF35-8-90GR	M8	18	9	13	8,5	12	20,5	22,5	3,9	16	PVL350, V600, DV1300, DV250	100	13
35	2	KRF35-10-90GR	M10	18	9	13	11,5	13,5	25	22,5	3,9	16	PVL350, V600, DV1300, DV250	100	13
50	1/0	KRF50-8-90GR	M8	21	11	14,5	8,5	17,5	26	30,5	3,4	19	PVL350, V600, DV1300, DV250	100	14,5
50	1/0	KRF50-10-90GR	M10	21	11	14,5	11,5	18,5	30	30,5	3,3	19	PVL350, V600, DV1300, DV250	100	14,5
50	1/0	KRF50-12-90GR	M12	21	11	14,5	12,5	19,5	32	30,5	3,3	19	PVL350, V600, DV1300, DV250	100	14,5
70	2/0	KRF70-8-90GR	M8	24	13	17	8,5	17,5	26	31,5	3,9	22	PVL350, V600, DV1300, DV250	50	17
70	2/0	KRF70-10-90GR	M10	24	13	17	11,5	18,5	30	31,5	3,9	22	PVL350, V600, DV1300, DV250	50	17
70	2/0	KRF70-12-90GR	M12	24	13	17	12,5	19,5	32	31,5	3,9	22	PVL350, V600, DV1300, DV250	50	17
95	4/0	KRF95-10-90GR	M10	28	15	20	11,5	18,5	30	32,5	4,9	25	V600, DV1300, DV250	50	20
95	4/0	KRF95-12-90GR	M12	28	15	20	12,5	19,5	32	32,5	4,9	25	V600, DV1300, DV250	50	20
95	4/0	KRF95-16-90GR	M16	29	15	20	15,5	20,5	36	32,5	4,8	25	V600, DV1300, DV250	50	20
120	250	KRF120-8-90GR	M8	32	17	22	8,5	17,5	26	42	4,9	27	V600, DV1300, DV250	25	22
120	250	KRF120-8-90GR-SB	M8	32	17	22	8,5	17,5	26	34,5	4,9	27	V600, DV1300, DV250	25	22
120	250	KRF120-10-90GR	M10	32	17	22	11,5	18,5	30	42	4,9	27	V600, DV1300, DV250	25	22
120	250	KRF120-10-90GR-SB	M10	32	17	22	11,5	18,5	30	34,5	4,9	27	DV250	25	22
120	250	KRF120-12-90GR	M12	32	17	22	12,5	19,5	32	42	4,9	27	V600, DV1300, DV250	25	22
120	250	KRF120-12-90GR-SB	M12	32	17	22	12,5	19,5	32	34,5	4,9	27	DV250	25	22
120	250	KRF120-16-90GR	M16	32	17	22	15,5	20,5	36	42	4,9	27	V600, DV1300, DV250	25	22
120	250	KRF120-16-90GR-SB	M16	32	17	22	15,5	20,5	36	34,5	4,9	27	DV250	25	22
150	300	KRF150-10-90GR	M10	36	19	25	11,5	18,5	30	47	5,9	32	V600, DV1300, DV250	25	25
150	300	KRF150-10-90GR-SB	M10	36	19	25	11,5	18,5	30	37,5	5,9	32	DV250	25	25
150	300	KRF150-12-90GR	M12	36	19	25	12,5	19,5	32	47	5,9	32	V600, DV1300, DV250	25	25
150	300	KRF150-12-90GR-SB	M12	36	19	25	12,5	19,5	32	37,5	5,9	32	DV250	25	25
150	300	KRF150-16-90GR-LB	M16	36	19	25	15,5	20,5	36	47	5,9	32	V600, DV1300, DV250	25	25
150	300	KRF150-16-90GR-SB	M16	36	19	25	15,5	20,5	36	37,5	5,9	32	DV250	25	25
185	350	KRF185-10-90GR-SB	M10	39	21	27	11,5	18,5	30	42,5	5,9	37	V1300, V250	25	27
185	350	KRF185-12-90GR-SB	M12	39	21	27	12,5	19,5	32	42,5	5,9	37	V1300, V250	25	27
185	350	KRF185-16-90GR-SB	M16	39	21	27	15,5	20,5	36	42,5	5,9	37	V1300, V250	25	27

t = palm thickness, s = strip length, SB = short barrel

04

KRT tube terminals 10 - 500 mm²

- Material: Cu 99.95%, tin plated Cu/Sn.
- Inspection hole.
- For stranded (class 2) Cu conductors.
- UL approved (10-500 mm²), DNV approved (10-400 mm²).



Example of marking KRT: 16 (neck) Elpress logotype 70 10 (palm)

16 = Die No. 70 = mm² 10 = palm hole for M10

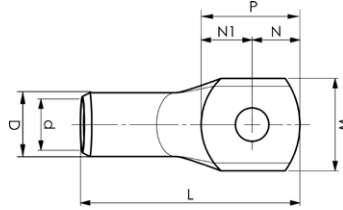

mm ² (Cu)	AWG Cu	Name	Screw	W mm	d	D	N	N1	P	L	t	s	Tool	Pcs/ pack	Die
10	8	KRT10-5	M5	10	4,5	7	6	8	14	29	2,4	11	PVL350, V600, V1300, V250	100	7
10	8	KRT10-6	M6	10	4,5	7	6	8	14	29	2,4	11	PVL350, V600, V1300, V250	100	7
10	8	KRT10-8	M8	13	4,5	7	8	11	19	34	1,8	11	PVL350, V600, V1300, V250	100	7
10	8	KRT10-10	M10	16	4,5	7	8	10,5	18,5	34	1,5	11	PVL350, V600, V1300, V250	100	7
10	8	KRT10-12	M12	19	4,5	7	10	14	24	41	1,2	11	PVL350, V600, V1300, V250	100	7
16	6	KRT16-5	M5	12	5,5	8,5	6	8	14	34	2,9	15	PVL350, V600, V1300, V250	100	8,5
16	6	KRT16-6	M6	12	5,5	8,5	6	8	14	34	2,9	15	PVL350, V600, V1300, V250	100	8,5
16	6	KRT16-8	M8	15	5,5	8,5	8	11	19	39	2,4	15	PVL350, V600, V1300, V250	100	8,5
16	6	KRT16-10	M10	16	5,5	8,5	8	11	19	39	2,2	15	PVL350, V600, V1300, V250	100	8,5
16	6	KRT16-12	M12	19	5,5	8,5	10	15	25	47	1,9	15	PVL350, V600, V1300, V250	100	8,5
25	4	KRT25-5	M5	14	7	10	9	12	21	43	2,9	17	PVL350, V600, V1300, V250	100	10
25	4	KRT25-6	M6	14	7	10	9	12	21	43	2,9	17	PVL350, V600, V1300, V250	100	10
25	4	KRT25-8	M8	15	7	10	9	12	21	43	2,8	17	PVL350, V600, V1300, V250	100	10
25	4	KRT25-10	M10	16	7	10	9	12	21	43	2,7	17	PVL350, V600, V1300, V250	100	10
25	4	KRT25-12	M12	19	7	10	12	13	25	48	2,1	17	PVL350, V600, V1300, V250	100	10
25	4	KRT25-16	M16	25	7	10	15	16	31	54	1,7	17	PVL350, V600, V1300, V250	100	10
35	2	KRT35-6	M6	17	8,5	12	9,5	11,5	21	49	3,4	20	PVL350, V600, V1300, V250	100	12
35	2	KRT35-8	M8	17	8,5	12	9,5	11,5	21	49	3,4	20	PVL350, V600, V1300, V250	100	12
35	2	KRT35-10	M10	19	8,5	12	9,5	11,5	21	49	3,1	20	PVL350, V600, V1300, V250	100	12
35	2	KRT35-12	M12	22	8,5	12	12	14	26	53	2,5	20	PVL350, V600, V1300, V250	100	12
35	2	KRT35-16	M16	25	8,5	12	15	16	31	59	2,2	20	PVL350, V600, V1300, V250	100	12
50	1/0	KRT50-6	M6	20	10	14	11	11	22	53	3,9	22	PVL350, V600, V1300, V250	50	14
50	1/0	KRT50-8	M8	20	10	14	11	11	22	53	3,9	22	PVL350, V600, V1300, V250	50	14
50	1/0	KRT50-10	M10	20	10	14	11	11	22	53	3,9	22	PVL350, V600, V1300, V250	50	14
50	1/0	KRT50-12	M12	22	10	14	12	14	26	56	3,5	22	PVL350, V600, V1300, V250	50	14
50	1/0	KRT50-16	M16	25	10	14	15	16	31	62	3,2	22	PVL350, V600, V1300, V250	50	14
70	2/0	KRT70-6	M6	23	12	16	11	11	22	55	3,9	23	PVL350, V600, V1300, V250	50	16
70	2/0	KRT70-8	M8	23	12	16	11	11	22	55	3,9	23	PVL350, V600, V1300, V250	50	16
70	2/0	KRT70-10	M10	23	12	16	11	11	22	55	3,9	23	PVL350, V600, V1300, V250	50	16
70	2/0	KRT70-12	M12	23	12	16	12	13	25	58	3,9	23	PVL350, V600, V1300, V250	50	16
70	2/0	KRT70-16	M16	26	12	16	15	16	31	64	3,5	23	PVL350, V600, V1300, V250	50	16
95	4/0	KRT95-8	M8	26	13,5	18	11	12	23	60	4,4	26	V600, V1300, V250	50	18
95	4/0	KRT95-10	M10	26	13,5	18	11	12	23	60	4,4	26	V600, V1300, V250	50	18
95	4/0	KRT95-12	M12	26	13,5	18	12	14	26	63	4,4	26	V600, V1300, V250	50	18
95	4/0	KRT95-16	M16	28	13,5	18	15	16	31	69	4	26	V600, V1300, V250	50	18
120	250	KRT120-8	M8	28	15	19	11	14	25	64	3,9	26	V600, V1300, V250	50	19
120	250	KRT120-10	M10	28	15	19	11	14	25	64	3,9	26	V600, V1300, V250	50	19
120	250	KRT120-12	M12	28	15	19	12	13	25	64	3,9	26	V600, V1300, V250	50	19
120	250	KRT120-16	M16	28	15	19	15	16	31	70	3,9	26	V600, V1300, V250	50	19
150	250	KRT150-10	M10	32	17	22	15	16	31	76	4,9	30	V600, V1300, V250	25	22
150	300	KRT150-12	M12	32	17	22	15	16	31	76	4,9	30	V600, V1300, V250	25	22
150	300	KRT150-16	M16	32	17	22	15	16	31	76	4,9	30	V600, V1300, V250	25	22
150	300	KRT150-20	M20	32	17	22	19	19	38	83	4,9	30	V600, V1300, V250	25	22
185	350	KRT185-10	M10	35	19	24	15	16	31	79	4,9	32	V600, V1300, V250	25	24
185	350	KRT185-12	M12	35	19	24	15	16	31	79	4,9	32	V600, V1300, V250	25	24
185	350	KRT185-16	M16	35	19	24	15	16	31	79	4,9	32	V600, V1300, V250	25	24
185	350	KRT185-20	M20	35	19	24	19	19	38	86	4,9	32	V600, V1300, V250	25	24
240	500	KRT240-10	M10	38	21	26	15	16	31	86	4,9	37	V600, V1300, V250	25	26
240	500	KRT240-12	M12	38	21	26	15	16	31	86	4,9	37	V600, V1300, V250	25	26
240	500	KRT240-16	M16	38	21	26	15	16	31	86	4,9	37	V600, V1300, V250	25	26
240	500	KRT240-20	M20	38	21	26	19	19	38	93	4,9	37	V600, V1300, V250	25	26
300	600	KRT300-10	M10	44	24	30	19	19	38	100	5,8	42	V1300, V250	10	30
300	600	KRT300-12	M12	44	24	30	19	19	38	100	5,8	42	V1300, V250	10	30
300	600	KRT300-16	M16	44	24	30	19	19	38	100	5,8	42	V1300, V250	10	30
300	600	KRT300-20	M20	44	24	30	19	19	38	100	5,8	42	V1300, V250	10	30
300	600	KRT300-24	M24	45	24	30	23	23	46	108	5,3	42	V1300, V250	10	30
400	750	KRT400-12	M12	48	26	32	22	31	53	116	5,8	44	V1300, V250	10	32
400	750	KRT400-16	M16	48	26	32	22	31	53	116	5,8	44	V1300, V250	10	32
400	750	KRT400-20	M20	48	26	32	22	31	53	116	5,8	44	V1300, V250	10	32
400	750	KRT400-24	M24	48	26	32	22	31	53	116	5,8	44	V1300, V250	10	32
500	1000	KRT500-12	M12	58	31	40	25	35	60	150	8,8	70	V250, V1470	10	40
500	1000	KRT500-14	M14	58	31	40	25	35	60	150	8,8	70	V250, V1470	10	40
500	1000	KRT500-16	M16	58	31	40	25	35	60	150	8,8	70	V250, V1470	10	40
500	1000	KRT500-20	M20	58	31	40	25	35	60	150	8,8	70	V250, V1470	10	40

t = palm thickness, s = strip length, SB = short barrel



ELPRESS

KRD tube terminals 16 - 1000 mm²

- Material: Cu 99.95%, tin plated Cu/Sn.
- Inspection hole.
- For stranded (class 2) Cu conductors.



Example of marking KRD:
14 (neck) Elpress logotype
70 10 (palm)
 14 = Die No. 70 = mm²
 10 = palm hole for M10

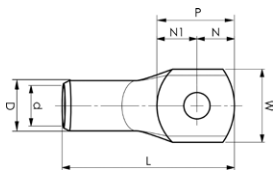

mm ² (Cu)	AWG Cu	Name	Screw	W mm	d	D	N	N1	P	L	t	s	Tool	Pcs/pack	Die
16	6	KRD16-5	M5	12	5,4	8	6	8	14	29	2,5	10	PVL350, V600, V1300, V250	100	8
16	6	KRD16-6	M6	12	5,4	8	6	8	14	29	2,5	10	PVL350, V600, V1300, V250	100	8
16	6	KRD16-8	M8	14	5,4	8	8	9	17	33	2,1	10	PVL350, V600, V1300, V250	100	8
16	6	KRD16-10	M10	16	5,4	8	8	10	18	34	1,8	10	PVL350, V600, V1300, V250	100	8
16	6	KRD16-12	M12	18	5,4	8	10	13,5	23,5	41	1,6	10	PVL350, V600, V1300, V250	100	8
25	4	KRD25-00		16	6,7	9			22	38	1,8	10	PVL350, V600, V1300, V250	100	9
25	4	KRD25-6	M6	13	6,7	9	7	9	16	32	2,2	10	PVL350, V600, V1300, V250	100	9
25	4	KRD25-8	M8	13	6,7	9	7	9	16	32	2,2	10	PVL350, V600, V1300, V250	100	9
25	4	KRD25-10	M10	16	6,7	9	10	12	22	38	1,8	10	PVL350, V600, V1300, V250	100	9
25	4	KRD25-12	M12	22	6,7	9	12	13	25	47	1,6	13	PVL350, V600, V1300, V250	100	9
35	2	KRD35-00	M35		8	11				39			PVL350, V600, V1300, V250	100	11
35	2	KRD35-6	M6	16	8	11	8	10	18	39	2,9	13	PVL350, V600, V1300, V250	100	11
35	2	KRD35-8	M8	16	8	11	8	10	18	39	2,9	13	PVL350, V600, V1300, V250	100	11
35	2	KRD35-10	M10	17	8	11	10	11	21	42	2,7	13	PVL350, V600, V1300, V250	100	11
35	2	KRD35-12	M12	22	8	11	12	13	25	47	2,1	13	PVL350, V600, V1300, V250	100	11
35	2	KRD35-14	M14	22	8	11	12	13	25	47	2	13	PVL350, V600, V1300, V250	100	11
35	2	KRD35-16	M16	25	8	11	15	18	33	56	1,7	13	PVL350, V600, V1300, V250	100	11
50	1/0	KRD50-6	M6	18	9,5	12	8,5	11,5	20	44	2,4	16	PVL350, V600, V1300, V250	100	12
50	1/0	KRD50-8	M8	18	9,5	12	8,5	11,5	20	44	2,4	16	PVL350, V600, V1300, V250	100	12
50	1/0	KRD50-10	M10	18	9,5	12	9,5	11,5	21	49	2,4	20	PVL350, V600, V1300, V250	100	12
50	1/0	KRD50-12	M12	20	9,5	12	12	14	26	53	2,2	20	PVL350, V600, V1300, V250	100	12
50	1/0	KRD50-16	M16	23	9,5	12	15	18	33	60,5	1,8	20	PVL350, V600, V1300, V250	100	12
70	2/0	KRD70-00		25	11,3	14			31	63	2,2	23	PVL350, V600, V1300, V250	50	14
70	2/0	KRD70-7	M7	22	11,3	14	11	11	22	54	2,5	23	PVL350, V600, V1300, V250	50	14
70	2/0	KRD70-8	M8	22	11,3	14	11	11	22	54	2,6	23	PVL350, V600, V1300, V250	50	14
70	2/0	KRD70-10	M10	22	11,3	14	11	11	22	54	2,6	23	PVL350, V600, V1300, V250	50	14
70	2/0	KRD70-12	M12	22	11,3	14	12	13	25	57	2,6	23	PVL350, V600, V1300, V250	50	14
70	2/0	KRD70-16	M16	25	11,3	14	15	16	31	63	2,2	23	PVL350, V600, V1300, V250	50	14
95	4/0	KRD95-00		28	13	16			31	67	2,5	26	PVL350, V600, V1300, V250	50	16
95	4/0	KRD95-6	M6	24	13	16	11	11	22	58	3	26	PVL350, V600, V1300, V250	50	16
95	4/0	KRD95-8	M8	24	13	16	11	11	22	58	2,9	26	PVL350, V600, V1300, V250	50	16
95	4/0	KRD95-10	M10	24	13	16	11	11	22	58	2,9	26	PVL350, V600, V1300, V250	50	16
95	4/0	KRD95-12	M12	24	13	16	12	13	25	61	2,9	26	PVL350, V600, V1300, V250	50	16
95	4/0	KRD95-14	M14	24	13	16	12	13	25	61	2,8	26	PVL350, V600, V1300, V250	50	16
95	4/0	KRD95-16	M16	28	13	16	15	16	31	67	2,5	26	PVL350, V600, V1300, V250	50	16
120	250	KRD120-00		28	15	19			31	70	3,8	26	V600, V1300, V250	50	19
120	250	KRD120-8	M8	28	15	19	11	14	25	64	3,8	26	V600, V1300, V250	50	19
120	250	KRD120-10	M10	28	15	19	11	14	25	64	3,9	26	V600, V1300, V250	50	19
120	250	KRD120-12	M12	28	15	19	11	14	25	64	3,9	26	V600, V1300, V250	50	19
120	250	KRD120-14	M14	28	15	19	15	17	32	70	4	26	V600, V1300, V250	50	19
120	250	KRD120-16	M16	28	15	19	15	16	31	70	3,9	26	V600, V1300, V250	50	19
120	250	KRD120-20	M20	30	15	19	16,5	18,5	35	74	3,7	26	V600, V1300, V250	50	19
150	300	KRD150-00		32	17	22			38	83	4,8	30	V600, V1300, V250	50	22
150	300	KRD150-8	M8	32	17	22	15	23	38	83	4,8	30	V600, V1300, V250	50	22
150	300	KRD150-10	M10	32	17	22	15	16	31	76	4,9	30	V600, V1300, V250	50	22
150	300	KRD150-12	M12	32	16	22	15	16	31	76	4,9	30	V600, V1300, V250	50	22
150	300	KRD150-14	M14	32	17	22	15	17	32	76	5	30	V600, V1300, V250	50	22
150	300	KRD150-16	M16	32	17	22	15	16	31	76	4,9	30	V600, V1300, V250	50	22
150	300	KRD150-20	M20	32	17	22	19	19	38	83	4,9	30	V600, V1300, V250	50	22
185	350	KRD185-00		36	19	25			38	87	5,9	32	V600, V1300, V250	50	25
185	350	KRD185-8	M8	36	19	25	15	16	31	80	5,9	32	V600, V1300, V250	50	25
185	350	KRD185-10	M10	36	19	25	15	16	31	80	5,9	32	V600, V1300, V250	50	25
185	350	KRD185-12	M12	36	19	25	15	16	31	80	5,9	32	V600, V1300, V250	50	25
185	350	KRD185-14	M14	36	19	25	15	16	31	80	5,8	32	V600, V1300, V250	50	25
185	350	KRD185-16	M16	36	19	25	15	16	31	80	5,9	32	V600, V1300, V250	50	25
185	350	KRD185-20	M20	36	19	25	19	19	38	87	5,9	32	V600, V1300, V250	50	25
240	500	KRD240-00		39	21	27			38	93	5,9	37	V1300, V250	50	27
240	500	KRD240-10	M10	39	21	27	15	16	31	86	5,9	37	V1300, V250	50	27
240	500	KRD240-12	M12	39	21	27	15	16	31	86	5,9	37	V1300, V250	50	27
240	500	KRD240-16	M16	39	21	27	15	16	31	86	5,9	37	V1300, V250	50	27
240	500	KRD240-20	M20	39	21	27	19	19	38	93	5,9	37	V1300, V250	50	27

t = palm thickness, s = strip length



04



KRD tube terminals 16 - 1000 mm²

- Material: Cu 99.95%, tin plated Cu/Sn.
- Inspection hole.
- For stranded (class 2) Cu conductors.



Example of marking KRD:
14 (neck) Elpress logotype
70 10 (palm)
 14 = Die No. 70 = mm²
 10 = palm hole for M10

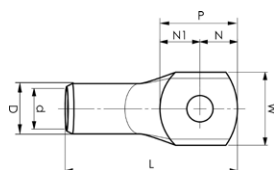

mm ² (Cu)	AWG Cu	Name	Screw	W mm	d	D	N	N1	P	L	t	s	Tool	Pcs/ pack	Die
300	600	KRD300-00		44	24	30			38	100	5,8	42	V1300, V250	25	30
300	600	KRD300-10	M10	44	24	30	19	19	38	100	5,8	42	V1300, V250	25	30
300	600	KRD300-12	M12	44	24	30	19	19	38	100	5,8	42	V1300, V250	25	30
300	600	KRD300-14	M14	44	24	30	19	20	39	100	6	42	V1300, V250	25	30
300	600	KRD300-16	M16	44	24	30	19	19	38	100	5,8	42	V1300, V250	25	30
300	600	KRD300-20	M20	44	24	30	19	19	38	100	5,8	42	V1300, V250	25	30
300	600	KRD300-24	M24	44	24	30	22	24	46	108	5,8	42	V1300, V250	25	30
400	750	KRD400-00		48	26	32			53	116	5,8	44	V1300, V250	25	32
400	750	KRD400-12	M12	48	26	32	22	31	53	116	5,8	44	V1300, V250	25	32
400	750	KRD400-14	M14	48	26	32	22	31	53	116	5,8	44	V1300, V250	25	32
400	750	KRD400-16	M16	48	26	32	22	31	53	116	5,8	44	V1300, V250	25	32
400	750	KRD400-24	M24	48	26	32	22	31	53	116	5,8	44	V1300, V250	25	32
400	750	KRD400-20	M20	48	26	32	22	31	53	116	5,8	44	V1300, V250	25	32
500	1000	KRD500-00		58	31	40			70	160	8,8	70	V250, V1470	5	40
500	1000	KRD500-12	M12	58	31	40	25	35	60	150	8,8	70	V250, V1470	5	40
500	1000	KRD500-14	M14	58	31	40	25	35	60	150	8,8	70	V250, V1470	5	40
500	1000	KRD500-16	M16	58	31	40	25	35	60	150	8,8	70	V250, V1470	5	40
500	1000	KRD500-20	M20	58	31	40	25	35	60	150	8,8	70	V250, V1470	5	40
500	1000	KRD500-24	M24	58	31	40	25	35	60	150	8,8	70	V250, V1470	5	40
630	1250	KRD630-00		65	34	45			75	165	10,8	70	V250, V1470	1	45
630	1250	KRD630-12	M12	65	34	45	25	35	60	150	10,8	70	V250, V1470	1	45
630	1250	KRD630-16	M16	65	34	45	25	35	60	150	10,8	70	V250, V1470	1	45
630	1250	KRD630-18	M18	65	34	45	25	35	60	150	11	70	V250, V1470	1	45
630	1250	KRD630-20	M20	65	34	45	25	35	60	150	10,8	70	V250, V1470	1	45
630	1250	KRD630-22	M22	65	34	45	25	35	60	134	11	52	V250, V1470	1	45
630	1250	KRD630-24	M24	65	34	45	25	35	60	150	10,8	70	V250, V1470	1	45
800	1600	KRD800-00		75	39	53			80	195	13,8	80	V250, V1470	1	53
800	1600	KRD800-16	M16	75	39	53	25	35	60	175	13,8	80	V250, V1470	1	53
800	1600	KRD800-24	M24	75	39	53	35	45	80	195	13,8	80	V250, V1470	1	53
1000	2000	KRD1000-00		80	43	56			80	195	12,8	80	V1470	1	56
1000	2000	KRD1000-20	M20	80	43	56	35	45	80	195	12,8	80	V1470	1	56
1000	2000	KRD1000-24	M24	80	43	56	35	45	80	195	12,8	80	V1470	1	56

t = palm thickness, s = strip length



DIN 46235 tube terminals 6 - 1000 mm²

- Din tube terminals for Cu conductors.
- Material: Cu 99.95%, tin plated Cu/Sn.
- Dimensions according to DIN 46235, the number of crimps is indicated on the neck of the terminal.
- For crimping DIN 46235 terminals, use dies according to DIN 48083.



Example of plate marking: 95 1095 = mm² 10 = palm hole for M10

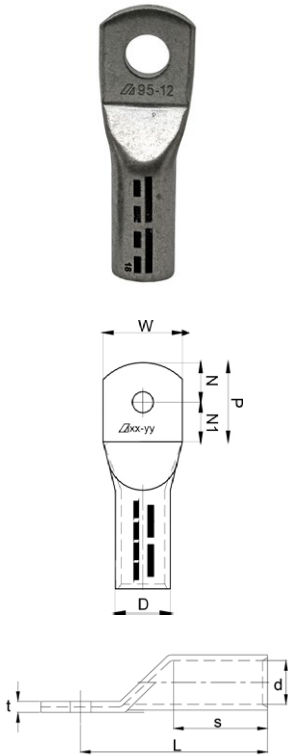

mm ² (Cu)	AWG Cu	Name	Screw	W mm	d	D	N	N1	P	L	t	s	Tool	Pcs/ pack	Die
6	10	KRDIN6-5	M5	8,5	3,8	5,5	7,5	7,5	15	31,5	1,5	10	V600, V1300	100	5DIN
6	10	KRDIN6-6	M6	8,5	3,8	5,5	9	9,5	18,5	33	1,5	10	V600, V1300	100	5DIN
6	10	KRDIN6-8	M8	13	3,8	5,5	10	10	20	35	1	10	V600, V1300	100	5DIN
10	8	KRDIN10-5	M5	9	4,5	6	7,5	7,5	15	34,5	1,5	10	V600, V1300	100	6DIN
10	8	KRDIN10-6	M6	9	4,5	6	9	9,5	18,5	36	1,5	10	V600, V1300	100	6DIN
10	8	KRDIN10-8	M8	13	4,5	6	10	10	20	37	1	10	V600, V1300	100	6DIN
10	8	KRDIN10-10	M10	15	4,5	6	10	11,5	21,5	39	0,8	10	V600, V1300	100	6DIN
16	6	KRDIN16-6	M6	13	5,5	8,5	9	9,5	18,5	45	2,5	20	V600, V1300	100	8DIN
16	6	KRDIN16-8	M8	13	5,5	8,5	11,5	11,5	23	47,5	2,5	20	V600, V1300	100	8DIN
16	6	KRDIN16-10	M10	17	5,5	8,5	13,5	13,5	27	49,5	1,9	20	V600, V1300	100	8DIN
16	6	KRDIN16-12	M12	18	5,5	8,5	13,5	13,5	27	52	1,8	20	V600, V1300	100	8DIN
25	4	KRDIN25-6	M6	14	7	10	9	9,5	18,5	47	3	20	V600, V1300	100	10DIN
25	4	KRDIN25-8	M8	16	7	10	11,5	11,5	23	49,5	2,5	20	V600, V1300	100	10DIN
25	4	KRDIN25-10	M10	17	7	10	13,5	13,5	27	51,5	2,4	20	V600, V1300	100	10DIN
25	4	KRDIN25-12	M12	19	7	10	14,5	14,5	29	52,5	2,1	20	V600, V1300	100	10DIN
35	2	KRDIN35-6	M6	17	8,2	12,5	7,5	8	15,5	49,5	4,1	20	V600, V1300	100	12DIN
35	2	KRDIN35-8	M8	17	8,2	12,5	11,5	11,5	23	53,5	4,1	20	V600, V1300	50	12DIN
35	2	KRDIN35-10	M10	19	8,2	12,5	13,5	13,5	27	55,5	3,7	20	V600, V1300	50	12DIN
35	2	KRDIN35-12	M12	21	8,2	12,5	14,5	14,5	29	56,5	3,3	20	V600, V1300	50	12DIN
50	1/0	KRDIN50-6	M6	20	10	14,5	11,5	11,5	23	63,5	4,3	28	V600, V1300	50	14DIN
50	1/0	KRDIN50-8	M8	20	10	14,5	11,5	11,5	23	63,5	4,3	28	V600, V1300	50	14DIN
50	1/0	KRDIN50-10	M10	22	10	14,5	13,5	13,5	27	65,5	3,9	28	V600, V1300	50	14DIN
50	1/0	KRDIN50-12	M12	24	10	14,5	14,5	14,5	29	66,5	3,6	28	V600, V1300	50	14DIN
50	1/0	KRDIN50-16	M16	28	10	14,5	17,5	17,5	35	69,5	3,1	28	V600, V1300	50	14DIN
70	2/0	KRDIN70-6	M6	24	11,5	16,5	11,5	11,5	23	66,5	4,5	28	V600, V1300	25	16DIN
70	2/0	KRDIN70-8	M8	24	11,5	16,5	11,5	11,5	23	66,5	4,5	28	V600, V1300	25	16DIN
70	2/0	KRDIN70-10	M10	24	11,5	16,5	13,5	13,5	27	68,5	4,5	28	V600, V1300	25	16DIN
70	2/0	KRDIN70-12	M12	24	11,5	16,5	14,5	14,5	29	69,5	4,5	28	V600, V1300	25	16DIN
70	2/0	KRDIN70-16	M16	30	11,5	16,5	17,5	17,5	35	72,5	3,7	28	V600, V1300	25	16DIN
95	4/0	KRDIN95-8	M8	28	13,5	19	13,5	13,5	27	78,5	5	35	V600, V1300	25	18DIN
95	4/0	KRDIN95-10	M10	28	13,5	19	13,5	13,5	27	78,5	5	35	V600, V1300	25	18DIN
95	4/0	KRDIN95-12	M12	28	13,5	19	14,5	14,5	29	79,5	5	35	V600, V1300	25	18DIN
95	4/0	KRDIN95-16	M16	32	13,5	19	17,5	17,5	35	82,5	4,4	35	V600, V1300	25	18DIN
120	250	KRDIN120-10	M10	32	15,5	21	13,5	13,5	27	83,5	5	35	V600, V1300	20	20DIN
120	250	KRDIN120-12	M12	32	15,5	21	14,5	14,5	29	84,5	5	35	V600, V1300	20	20DIN
120	250	KRDIN120-16	M16	32	15,5	21	17,5	17,5	35	87,5	5	35	V600, V1300	20	20DIN
120	250	KRDIN120-20	M20	38	15,5	21	20,5	20,5	41	90,5	4,1	35	V600, V1300	20	20DIN
150	300	KRDIN150-10	M10	34	17	23,5	13,5	13,5	27	91,5	6	35	V600, V1300	20	22DIN
150	300	KRDIN150-12	M12	34	17	23,5	14,5	14,5	29	92,5	6	35	V600, V1300	20	22DIN
150	300	KRDIN150-16	M16	34	17	23,5	17,5	17,5	35	95,5	6	35	V600, V1300	20	22DIN
150	300	KRDIN150-20	M20	40	17	23,5	20,5	21,5	42	98,5	5,2	35	V600, V1300	20	22DIN
185	350	KRDIN185-10	M10	37	19	25,5	13,5	13,5	27	95,5	6	40	V1300, V250	10	25DIN
185	350	KRDIN185-12	M12	37	19	25,5	13,5	13,5	27	95,5	6	40	V1300, V250	10	25DIN
185	350	KRDIN185-16	M16	37	19	25,5	17,5	17,5	35	99,5	6	40	V1300, V250	10	25DIN
185	350	KRDIN185-20	M20	40	19	25,5	20,5	21,5	42	102,5	5,7	40	V1300, V250	10	25DIN
240	500	KRDIN240-10	M10	42	21,5	29	14,5	14,5	29	117,5	7,1	40	V1300, V250	10	28DIN
240	500	KRDIN240-12	M12	42	21,5	29	14,5	14,5	29	106,5	7,1	40	V1300, V250	10	28DIN
240	500	KRDIN240-16	M16	42	21,5	29	17,5	17,5	35	109,5	7,1	40	V1300, V250	10	28DIN
240	500	KRDIN240-20	M20	45	21,5	29	20,5	21,5	42	112,5	6,5	40	V1300, V250	10	28DIN
300	600	KRDIN300-12	M12	48	24,5	32	17,5	17,5	35	117,5	7	50	V1300, V250	5	32DIN
300	600	KRDIN300-16	M16	48	24,5	32	17,5	17,5	35	117,5	7	50	V1300, V250	5	32DIN
300	600	KRDIN300-20	M20	48	24,5	32	20,5	21,5	42	120,5	7	50	V1300, V250	5	32DIN
400	750	KRDIN400-12	M12	55	27,5	38,5	23,5	17,5	41	138,5	10,4	70	V1300, V250	5	38DIN
400	750	KRDIN400-16	M16	55	27,5	38,5	23,5	17,5	41	138,5	10,4	70	V1300, V250	5	38DIN
400	750	KRDIN400-20	M20	55	27,5	38,5	23,5	21,5	45	138,5	10,4	70	V1300, V250	5	38DIN
500	1000	KRDIN500-20	M20	60	31	42	23,5	21,5	45	148,5	10,5	70	V250	2	42DIN
625	1250	KRDIN625-20	M20	63	34,5	44	23,5	21,5	45	158,5	9,3	80	V250	2	44DIN
800	1600	KRDIN800-20	M20	75	40	52	23,5	21,5	45	188,5	11,6	100	V1470	1	52DIN
1000	2000	KRDIN1000-20	M20	85	44	58	23,5	21,5	45	188,5	13,2	100	V1470	1	58DIN

t = palm thickness, s = strip length

DIN 46234 sheet metal terminals 10 - 185 mm²

- Material: Cu 99.9% tin plated Cu/Sn.
- Dimensions acc. to DIN 46234.

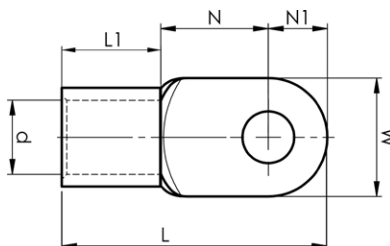

mm ² (Cu)	AWG Cu	Name	Screw	W mm	d	N	N1	L	Tool	Pcs/ pack	Die
10	8	B10-5R	M5	10	4,5	8	5	16	GWB4010, V600, V1300, V250	100	7
10	8	B10-6R	M6	11	4,5	9	5,5	17	GWB4010, V600, V1300, V250	100	7
10	8	B10-8R	M8	14	4,5	12	7	27	GWB4010, V600, V1300, V250	100	7
10	8	B10-10R	M10	18	4,5	13	9	21	GWB4010, V600, V1300, V250	100	7
10	8	B10-12R	M12	22	4,5	15	11	23	GWB4010, V600, V1300, V250	100	7
16	6	B16-5R	M5	11	5,8	10	5,5	26	V600, V1300, V250	100	8
16	6	B16-6R	M6	11	5,8	10	5,5	26	V600, V1300, V250	100	8
16	6	B16-8R	M8	14	5,8	12	7	29	V600, V1300, V250	100	8
16	6	B16-10R	M10	18	5,8	14	9	33	V600, V1300, V250	100	8
16	6	B16-12R	M12	22	5,8	16	11	37	V600, V1300, V250	100	8
16	6	B16-16R	M16	30	5,8	24	15	49	V600, V1300, V250	100	8
25	4	B25-6R	M6	12	7,5	14	6	31	V600, V1300, V250	100	10
25	4	B25-8R	M8	16	7,5	14	8	33	V600, V1300, V250	100	10
25	4	B25-10R	M10	18	7,5	15	9	35	V600, V1300, V250	100	10
25	4	B25-12R	M12	22	7,5	20	11	42	V600, V1300, V250	100	10
25	4	B25-16R	M16	28	7,5	24	14	49	V600, V1300, V250	100	10
35	2	B35-6R	M6	15	9	14	7,5	34	V600, V1300, V250	100	12
35	2	B35-8R	M8	16	9	14	8	34	V600, V1300, V250	100	12
35	2	B35-10R	M10	18	9	15	9	36	V600, V1300, V250	100	12
35	2	B35-12R	M12	22	9	19	11	42	V600, V1300, V250	100	12
35	2	B35-16R	M16	28	9	24	14	50	V600, V1300, V250	100	12
50	1/0	B50-6R	M6	18	11	18	9	43	V600, V1300, V250	100	14,5
50	1/0	B50-8R	M8	18	11	18	9	43	V600, V1300, V250	100	14,5
50	1/0	B50-10R	M10	18	11	18	9	43	V600, V1300, V250	100	14,5
50	1/0	B50-12R	M12	22	11	20	11	47	V600, V1300, V250	100	14,5
50	1/0	B50-16R	M16	28	11	24	14	54	V600, V1300, V250	100	14,5
70	2/0	B70-8R	M8	22	13	20	11	49	V600, V1300, V250	100	17
70	2/0	B70-10R	M10	22	13	20	11	49	V600, V1300, V250	100	17
70	2/0	B70-12R	M12	22	13	20	11	49	V600, V1300, V250	100	17
70	2/0	B70-16R	M16	28	13	24	14	56	V600, V1300, V250	100	17
95	4/0	B95-10R	M10	24	15	22	12	54	V600, V1300, V250	100	20
95	4/0	B95-12R	M12	24	15	22	12	54	V600, V1300, V250	100	20
95	4/0	B95-16R	M16	28	15	24	14	58	V600, V1300, V250	100	20
120	250	B120-10R	M10	24	16,5	22	12	56	V600, V1300, V250	50	*
120	250	B120-12R	M12	24	16,5	22	12	56	V600, V1300, V250	50	*
120	250	B120-16R	M16	28	16,5	26	14	62	V600, V1300, V250	50	*
150	300	B150-12R	M12	30	19	26	15	65	V600, V1300, V250	50	*
150	300	B150-16R	M16	30	19	26	15	65	V600, V1300, V250	50	*
185	350	B185-12R	M12	36	21	22	18	68	V1300, V250	50	*
185	350	B185-16R	M16	36	21	22	18	68	V1300, V250	50	*

* Contact Elpress



KS/KSF through connectors 0.75 - 800 mm²

- Material: Cu 99.95%, tin plated Cu/Sn.
- Inspection hole and int. cable stop.
- For stranded (class 2) and multi-stranded (class 5) Cu conductors.
- For multi-stranded Cu conductors Elpress recommends the DUAL system.
- UL approved (1-500 mm²). DNV approved (16-400 mm²).



Examples of marking: 20 95F (Elpress logotype is included on the marking.)

20 = Die No. 95 = mm² F = type KSF for stranded and flexible conductors 111 = screen mm²



mm ² (Cu)	AWG Cu	Name	Screen conductor	d mm	D	L	s	Tool	Pcs/ pack	Die
0,75	(22)-18	KS0,75		1,3	2,8	14	7	DKB0325, DKB0760	100	
1,5	(18)-16	KS1,5		1,8	3,3	14	7	DKB0325, DKB0760	100	
2,5	(16)-14	KS2,5		2,3	4,2	16	8	DKB0325, DKB0760	100	
4	12	KS4		3	5	19	9	GWB4099, ES2258	100	
6	10	KS6		4	6	19	9	GWB4099, ES2258	100	
10	8	KS10		5	8	30	15	GWB4099, ES2258, PVL350, V600, DV1300	100	8
16	6	KSF16	15	6	9	35	17	ES2258, PVL350, V600, DV1300	100	9
25	4	KSF25	21-29	8	11	35	17	ES2258, PVL350, V600, DV1300	100	11
35	2	KSF35	41	9	13	35	17	PVL350, V600, DV1300, DV250	100	13
50	1/0	KSF50	57	11	14,5	45	22	V600, DV1300, DV250	50	14,5
70	2/0	KSF70	72-88	13	17	45	22	V600, DV1300, DV250	50	17
95	4/0	KSF95	111	15	20	45	25	V600, DV1300, DV250	50	20
120	250	KSF120		17	22	55	27	V600, DV1300, DV250	50	22
150	300	KSF150		19	25	65	32	V600, DV1300, DV250	25	25
185	350	KSF185		21	27	70	35	DV1300, DV250	25	27
240	500	KSF240A		22,5	29	70	35	DV1300, DV250	25	30
300	600	KSF300A		24,5	31,5	75	37	DV1300, DV250	10	32
400	750	KSF400A		30	38	100	50	DV1300, DV250	10	38
500	1000	KSF500		33	42	135	68	DV250, V1470	5	42
630	1000	KSF630		39	53	175	88	DV250, V1470	3	53
800	1000	KSF800		42,5	53	175	88	DV250, V1470	2	53

s = strip length

KS/KSF through connectors with partition 10-500 mm²

- Material: Cu 99.95%, tin plated Cu/Sn.
- For stranded (class 2) and multi-stranded (class 5) Cu conductors.
- For multi-stranded Cu conductors Elpress recommends the DUAL system.
- With partition to prevent oil leakage.
- UL approved (1-500 mm²). DNV approved (16-400 mm²).



Examples of marking: 20 95F (Elpress logotype is included on the marking.)

20 = Die No. 95 = mm² F = type KSF for stranded and flexible conductors 111 = screen mm²

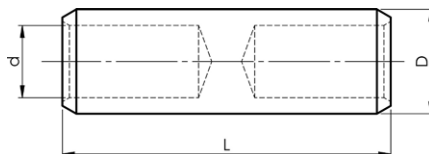

mm ² (Cu)	AWG Cu	Name	Screen conductor	d mm	D	L	s	Tool	Pcs/ pack	Die
10	8	KS10M		5	8	36	18	ES2258, PVL350, V600, DV1300	100	8
16	6	KSF16M	15	6	9	37	18	ES2258, PVL350, V600, DV1300	100	9
25	4	KSF25M	21-29	8	11	38	18	ES2258, PVL350, V600, DV1300	100	11
35	2	KSF35M	41	9	13	41	19	PVL350, V600, DV1300, DV250	100	13
50	1/0	KSF50M	57	11	14,5	48	22	PVL350, V600, DV1300, DV250	50	14,5
70	2/0	KSF70M	72-88	13	17	49	22	PVL350, V600, DV1300, DV250	50	17
95	3/0	KSF95M	111	15	20	56	25	V600, DV1300, DV250	50	20
120	250	KSF120M		17	22	63	28	V600, DV1300, DV250	50	22
150	300	KSF150M		19	25	64	28	V600, DV1300, DV250	25	25
185	350	KSF185M		21	27	74	32	DV1300, DV250	25	27
240	500	KSF240AM		22,5	29	76	32	DV1300, DV250	1	30
300	600	KSF300AM		24,5	31,5	88	37	DV1300, DV250	1	32
400	750	KSF400AM		30	38	105	45	DV1300, DV250	1	38
500	1000	KSF500M		33	42	135	54	DV250, V1470	1	42

s = strip length



KST through connectors with partition 10-500 mm²

- Material: Cu 99.95%, tin plated Cu/Sn.
- For stranded (class 2) Cu conductors.
- Cable inspection hole and cable stop.
- UL approved (1-500 mm²). DNV approved (16-400 mm²).



Examples of marking: 16 70 (Elpress logotype is included on the marking.)
16 = Die No. 70 = mm²

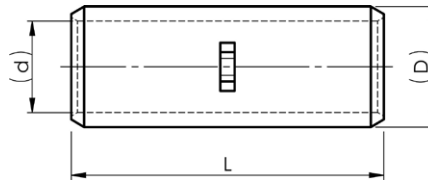

mm ² (Cu)	AWG Cu	Name	d mm	D	L	s	Tool	Pcs/ pack	Die
10	8	KST10	4,5	7	30	15	ES2258, PVL350, V600, V1300	100	7
16	6	KST16	5,5	8,5	35	17	EL2258, PVL350, V600, V1300	100	8,5
25	4	KST25	7	10	40	20	EL2258, PVL350, V600, V1300	100	10
35	2	KST35	8,5	12	45	22	PVL350, V600, V1300, V250	100	12
50	1/0	KST50	10	14	50	25	PVL350, V600, V1300, V250	50	14
70	2/0	KST70	12	16	55	27	PVL350, V600, V1300, V250	50	16
95	4/0	KST95	13,5	18	60	30	V600, V1300, V250	50	18
120	250	KST120	15	19	60	30	V600, V1300, V250	50	19
150	300	KST150	17	22	65	32	V600, V1300, V250	50	22
185	350	KST185	19	24	75	37	V600, V1300, V250	50	24
240	500	KST240	21	26	85	42	V600, V1300, V250	50	26
300	600	KST300	24	30	90	45	V1300, V250	50	30
400	750	KST400	26	32	90	45	V1300, V250	50	32
500	1000	KST500	31	40	135	68	V250, V1470	5	40

s = strip length

KSD through connectors with partition 16-1000 mm²

- Material: Cu 99.95%, tin plated Cu/Sn.
- For stranded (class 2) Cu conductors.
- Cable inspection hole and cable stop.
- UL approved (1-500 mm²). DNV approved (16-400 mm²).



Examples of marking: 16 95 (Elpress logotype is included on the marking.)
16 = Die No. 95 = mm²

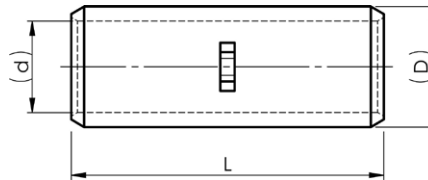

mm ² (Cu)	AWG Cu	Name	d mm	D	L	s	Tool	Pcs/pack	Die
16	6	KSD16	5,4	8	30	14	V600, V1300, PVL350, V250	100	8
25	4	KSD25	6,7	9	30	15	V600, V1300, PVL350, V250	100	9
35	2	KSD35	8	11	35	16	V600, V1300, PVL350, V250	100	11
50	1/0	KSD50	9,5	12	40	19	V600, V1300, PVL350, V250	50	12
70	2/0	KSD70	11,3	14	45	21	V600, V1300, PVL350, V250	50	14
95	4/0	KSD95	13	16	55	26	V600, V1300, PVL350, V250	50	16
120	250	KSD120	15	19	60	26	V600, V1300, PVL350, V250	50	19
150	300	KSD150	17	22	65	30	V1300, V250, V600	50	22
185	350	KSD185	19	25	70	32	V1300, V250, V600	50	25
240	500	KSD240	21	27	70	34	V1300, V250	50	27
300	600	KSD300	24	30	90	42	V1300, V250	50	30
400	750	KSD400	26	32	90	42	V1300, V250	25	32
500	1000	KSD500	31	40	135	64,5	V250, V1470	5	40
630	1250	KSD630	34	45	135	64,5	V250, V1470	5	45
800	1600	KSD800	39	53	175	79,5	V250, V1470	1	53
1000	2000	KSD1000	43	56	175	79,5	V1470	1	56

s = strip length

KSxP parallel connectors for conductors total 0.5 - 6.75 mm²

- Material: Cu 99.95%, tin plated Cu/Sn.
- For multi-stranded (class 5) and stranded (class 2) Cu conductors.
- For multi-stranded Cu conductors Elpress recommends the Dual system.

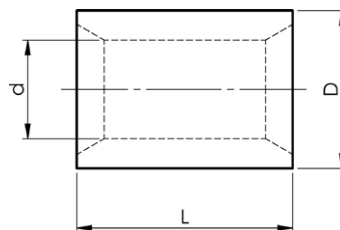

mm ² (Cu)	AWG Cu	Name	d	D	L	s	Tool	Pcs/pack
0,5-1,5	20-16	KS1,5P	1,6	3,2	7	3	DKB0325	100
1,5-3,0	16-12	KS2,5P	2,3	3,9	7	3	DKB0325	100
3,25-6,75	12-9	KS6P	3,6	5,6	7	3	DKB0760	100

s = strip length



KSxP parallel connectors for conductors total 10 - 630 mm²

- Material: Cu 99.95%, tin plated Cu/Sn.
- For stranded (class 2) and multi-stranded (class 5) Cu conductors.
- For multi-stranded Cu conductors Elpress recommends the Dual system.

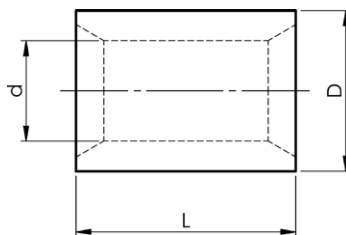

mm ² (Cu)	AWG Cu	Name	d mm	D	L	Tool	Pcs/ pack	Die
7-12	8	KS10P	5	8	11	PVL350, V600, DV1300, DV250	250	8
12,5-18,5	6	KS16P	6	9	12	PVL350, V600, DV1300, DV250	250	9
20-31	4	KS25P	8	11	14	PVL350, V600, DV1300, DV250	200	11
31-41	2	KS35P	9	13	16	PVL350, V600, DV1300, DV250	100	13
45-56	1/0	KS50P	11	14,5	18	PVL350, V600, DV1300, DV250	100	14,5
60-85	2/0	KS70P	13	17	18	PVL350, V600, DV1300, DV250	100	17
86-111	4/0	KS95P	15	20	20	V600, DV1300, DV250	100	20
111-130	250	KS120P	17	22	26	V600, DV1300, DV250	100	22
136-166	300	KS150P	19	25	26	V600, DV1300, DV250	50	25
170-210	350	KS185P	21	27	28	DV1300, DV250	25	27
220-255	500	KS240P	24	30	30	DV1300, DV250	25	30
300	600	KS300P	26	32	35	DV1300, DV250	10	32
400	750	KS400P	30	38	50	DV1300, DV250	10	38
500	1000	KS500P	33	42	52	DV250, V1470	10	42
630	1250	KS630P	39	50	62	DV250, V1470	10	50

04

CUT through connectors for single strand conductors 6 - 16 mm²

- Material: Cu 99.95%, tin plated Cu/Sn.
- For single-wire conductors (acc. to IEC 60228 class 1).

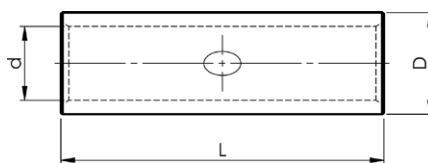

mm ² (Cu)	AWG Cu	Name	d mm	D	L	s	Tool	Pcs/ pack
6	10	CUT6	3	5	27	12	ES2258, T2258	100
10	8	CUT10	4	6	27	12	ES2258, T2258	100
16	6	CUT16	5	8	35	15,5	ES2258, T2258	100

s = strip length
The Elpress logo is included on the marking.

DIN 46230 pin terminals 10 - 95 mm²

- Material: Cu 99.95%, tin plated Cu/Sn.
- Dimensions according to DIN 46230.

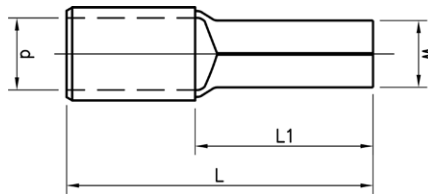

mm ² (Cu)	AWG Cu	Name	W mm	d	L	L1	Tool	Pcs/ pack	Die
10	8	B10SR	4,3	4,5	22	12	V600, V1300, V250	100	7
16	6	B16SR	5,5	5,8	26	13	V600, V1300, V250	100	8
25	4	B25SR	6,8	7	34	15	V600, V1300, V250	100	10
35	2	B35SR	8	8,7	41	20	V600, V1300, V250	100	12
50	1/0	B50SR	9,5	9,8	45	20	V600, V1300, V250	50	14,5
70	2/0	B70SR	11	11,5	55	23	V600, V1300, V250	50	17
95	3/0	B95SR	12,3	13,8	55	23	V600, V1300, V250	50	20

KRX tube terminals for Excel and Fxcel cable 10 - 16 mm²

- Material: Cu 99.95%, tin plated Cu/Sn
- For cable 10 mm² Cu Solid (Excel) and 16 mm² stranded (Fxcel), installed with strain relief.

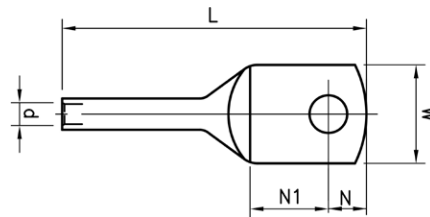

mm ² (Cu)	AWG Cu	Name	Screw	W mm	d	N	N1	L	t	s	Tool	Pcs/ pack	Die
10	8	KRX10-8	M8	22	4,5	8,5	17,5	68	3,5	30	V600, V1300	3	7
10	8	KRX10-10	M10	22	4,5	11,5	18,5	72	3,5	30	V600, V1300	3	7
10	8	KRX10-12	M12	22	4,5	12,5	19,5	74	3,5	30	V600, V1300	3	7
16	6	KRX16-8	M8	16	5,5	8,5	17,5	61	2,2	30	V600, V1300	3	8,5
16	6	KRX16-10	M10	16	5,5	11,5	18,5	65	2,2	30	V600, V1300	3	8,5
16	6	KRX16-12	M12	19	5,5	12,5	19,5	67	1,9	30	V600, V1300	3	8,5

t = palm thickness, s = strip length

KSX through connectors for Excel and Fxcel cable 10 - 16 mm²

- Material: Cu 99.95%, tin plated Cu/Sn
- For cable 10 mm² Cu Solid (Excel) and 16 mm² stranded (Fxcel), installed with strain relief.
- With internal cable stop

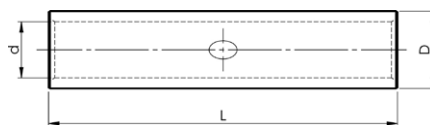

mm ² (Cu)	AWG Cu	Name	d mm	D	L	s	Tool	Pcs/ pack	Die
10	8	KSX10	4,5	7	65	30	V600, V1300	3	7
16	6	KSX16	5,5	8,5	65	30	V600, V1300	3	8,5

s = strip length

The Elpress logo is included on the marking. Two plus two crimps are carried out with the V600, V611, PVX611 or T2600 system, crimp die TB7-20.



ELPRESS

C-sleeves 6 - 300 mm²

- Material: Cu 99.95%. Tin plated sleeves (except C95-120, C150-185, C240-300 and C23 which are not tin plated).
- For splicing and branching earth lines and other types of equipotential bonding applications. In some cases, 2 or 3 crimps are required.
- Unique patented solution based on previously patented solution for the C25-50 branching sleeve (formerly known as C89).
- Possible to front feed all branches.

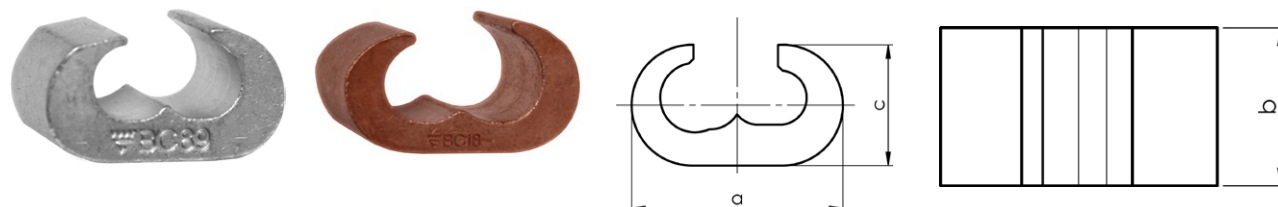

Name	Side feed mm ²	Front feed mm ²	a	b	c	Tool	Pcs/ pack	Die
C6-10	6/6-16, 10/6-16	6-10/6-10, 16/10	17,6	14	10	V600, V1300, V250	100	5
C16-25	16/16-25, 25/(2*2,5)-25	16-25/16-25, 25/(2*2,5)-10	22	16	12	V600, V1300, V250	100	6
C25-50	25-50/25-50, 16-50/35-50	16/35-50	30	18	16	V600, V1300, V250	50	8-9
C50-70	50/50, 70/25-70, 95/25-50	50/50, 70/25-70, 95/25-50	37	30	22	V1300, V250	50	13
C70-95	70/70, 95/50-95, 120/25-70	70/70, 95/50-70, 120/25-50	39	30	22,2	V1300, V250	50	13
C95-120	95/95, 120/70-120, 150/25-70, 185/25-50	95/95, 120/70-120, 150/25-70, 185/25-50	45	35	25,6	V1300, V250	25	15
C150-185	150/95-150, 185/70-185, 240/25-185, 300/25-120	150/95-150, 185/70-185, 240/25-185, 300/25-120	62,5	40	34,2	V250, V1470	10	18
C240-300	300/240, 300/185, 300/150, 240/240	300/240, 300/185, 300/150, 240/240	72	50	40,7	V250, V1470	10	21
C23	300/300	300/300	70	40	40	V250, V1470	10	21

Elpress logotype is included on the marking. The other side of the C sleeve is marked with the size of the Cu wire that fits.

ELPRESS C-sleeves														
MAIN CONDUCTOR	6	C6-10												
	10	C6-10	C6-10											
	16	C6-10	C6-10	C16-25										
	25	C16-25	C16-25	C16-25	C16-25	C25-50								
	35			C25-50	C25-50	C25-50								
	50	C25-50	C25-50	C25-50	C25-50	C25-50	C25-50*	C50-70						
	70				C50-70	C50-70	C50-70	C50-70	C50-70	C70-95				
	95				C50-70	C50-70	C50-70	C70-95	C70-95	C70-95*	C95-120			
	120				C70-95	C70-95	C70-95	C70-95	C95-120	C95-120	C150-185	C150-185	C150-185	
	185				C95-120	C95-120	C95-120	C150-185	C150-185	C150-185	C150-185	C150-185	C150-185	
	240				C150-185	C150-185	C150-185	C150-185	C150-185	C150-185	C150-185	C150-185	C150-185**	C240-300
	300				C150-185	C150-185	C150-185	C150-185	C150-185	C150-185	C240-300	C240-300	C240-300	C23
 mm ²	6	10	16	25	35	50	70	95	120	150	185	240	300	
	BRANCH													

* Side feed only

** For Front feed with uncompressed conductors, use C240-300

Reference list, see next page

Reference list

C-sleeves	Replace sleeve	Dimension (mm)			Weight (kg)	Name Area mm ² Total area mm ²	Tool				
		Crimp Head					V250 V1470				
		V611	V1300	V1300C2							
		T2600	V1311-A	V1311C2-A							
		PVX611	PVX1300	PVX1300C2							
V600	Die number										
C6-10	C4 C5	17,6	14	10	0,011	C6-10 6-16 12-26	1 crimp TBC5-C6	1 crimp BC5 ²	1 crimp BC5 ³	1 crimp BC5 ³	
C16-25	C6 C6-3	22	16	12	0,018	C16-25 5-25 30-50	1 crimp TBC5-C6	1 crimp BC6 ²	1 crimp BC6 ³	1 crimp BC6 ¹	
C25-50	C89***	30	18	16	0,040	C25-50 6-50 50-100	2 crimps TBC89-B13	1 crimp 13BC8-9	1 crimp BC8-9 ²	1 crimp BC8-9 ³	1 crimp BC8-9 ¹
C50-70	C11 C11-9 C11-8 C13-9 C13-8	37	30	22	0,097	C50-70 25-95 95-145		3 crimps 13BC13	3 crimps 13CBC13	1 crimps BC13 ¹	
C70-95	C13** C13-13 C13-11 C15-11** C15-9 C15-8	39	30	22,1	0,093	C70-95 25-120 140-190		3 crimps 13BC13	3 crimps 13CBC13	1 crimps BC13 ¹	
C95-120	C15 C15-13 C16-9 C18-9 C18-8	45	35	25,6	0,133	C95-120 25-185 175-240		3 crimps 13BC15	3 crimps 13CBC15	1 crimps B25C15	
C150-185	C16 C21-18* C16-13 C18 C18-16 C18-15 C18-13 C18-11 C18/23-8 C21-15 C21-16 C21-13 C21-11 C21-9 C21-8	62,5	40	34,5	0,329	C150-185 25-300 245-425				2 crimps B25C18 1 crimp B40C18	
C240-300	C21 C23-21 C23-18 C23-16	72	50	40,7	0,555	C240-300 150-300 450-540				2 crimps B25C21 1 crimp B40C21	
C23	C23	70	40	40	0,403	C23 300 600				2 crimps B25C21 1 crimp B40C21	

* Non-compacted main conductor and branch, use C240-300

** Side feed, front feed in C95/120

*** 50 mm²/50 mm² side feed, front feed in C50-70

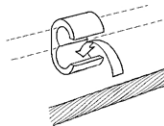

Front feed

- 1) Die holder required: V2506, V2508
- 2) Die holder required: V1316, V1318
- 3) Die holder required: V1330



Notes

Al and AlCu terminals 16 - 1200 mm²

General information about Al and AlCu terminals	2
Aluminium terminals 16 - 1200 mm ²	3
Aluminium through connectors with partition 16 - 1200 mm ²	4
Through connectors with aluminium partitions with different areas 16 - 400 mm ²	5
Aluminium through connectors with cable stop 300 - 400 mm ²	5
Aluminium-copper terminals 16 - 1200 mm ²	6
Aluminium-copper terminals 300 - 400 mm ²	7
Aluminium-copper pin sockets 16 - 300 mm ²	7
Through connectors of aluminium 16 - 95 mm ² to solid copper 10 mm ²	8
Through connectors of aluminium-copper 300 - 400 mm ²	8
Aluminium-copper through connectors 16 - 400 mm ²	9

General information about Al and AlCu terminals



System Elpress

System Elpress consists of terminals and tools that are designed and tested together to give a certified crimping result. This ensures that users will feel confident when using our systems, and that a secure connection is achieved through the proper handling of our products.

Al terminals

Elpress terminals for Al cable are made of solid and pure aluminium 99.7%. We manufacture Al terminals type AK and AS, but also customised terminals or terminals larger than 1200 mm².



Terminal type AK is used with Al conductors for connection to busbars and apparatus sockets.



Through connectors type AS are used when connecting aluminium-conductors.

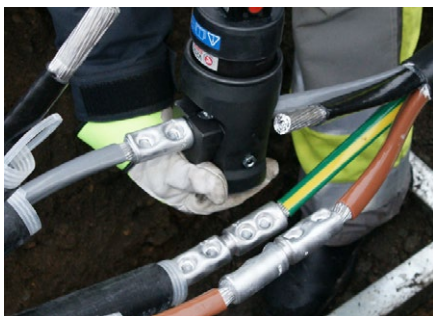

Indent crimping of Elpress through connector using crimp head V250.

AlCu terminals

Elpress bimetallic terminals (AlCu) are manufactured from solid material which is friction welded together, joining Aluminium with Copper. This is done when aluminium is rotated towards copper under pressure and it is the method that provides the best connection between Al and Cu.



Terminals of type AKK are used at the end of an Al conductor for connection to a Cu bus bar.



Through connectors of type AKS are used to connect Al conductors to Cu conductors.



Pin sockets type AKP are manufactured for connection of Al conductors to apparatus intended for copper pin connections.

Number of crimps

The Elpress system is suitable for both stranded conductors, acc. to IEC 60228 class 2, and solid conductors, acc. to IEC60228 class 1. However, it should be noted that there is an area difference between stranded and solid Al conductors (see tables). When using sectoral Al-cable, a pre-rounding is normally required, which is done with a round crimping tool. When contact crimping Al terminals, two crimps should always be made. Note the crimp sequence.

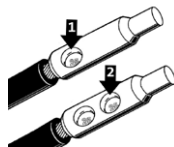

Customised products

Customised products are an important part of our work. Solving problems for the customer and at the same time manufacturing the products with profitability is a special challenge. This way, we also increase our knowledge of the customers' needs. The above terminals include different models of T-connectors where you can connect three conductors of the same size using only one terminal.

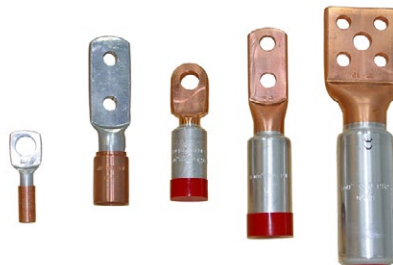

Upon request for variants in hole arrangement, the size of the connection flag and the like, we make variants of cable clips.

Marking Al and AlCu terminals

Elpress system for marking Al and AlCu terminals states the conductor area (for small and solid conductors) and reference to rounded and contact crimp tools within the Elpress range. A tool reference for hexagonal crimping copper is given on the bimetallic through connectors.

TERMINALS:

Explanatory marking Al and AlCu terminals
Barrel marking i.e. ALU300-R21-P36 (Elpress logotype) T2

ALU300 = Al conductor in mm²

R21 = size no. for punch and matrix for pre-rounding

P36 = size no. for punch and matrix for crimping

Palm marking: (Elpress logo) 16 = Screw dimension

THROUGH CONNECTORS:

Explanatory marking Al and AlCu terminals

For example: Cu240 - 30 (Elpress logotype)

Cu240 = Cu conductor in mm²

30 = Size no. for hexagonal die

For example: ALU300-R21-P36 (Elpress logotype) T2

ALU300 = Al conductor in mm²

R21 = size no. for punch and matrix for pre-rounding

P36 = size no. for punch and matrix for crimping

Clearance for holes in terminal palm

Screw size	Hole diameter (Ø mm)
M3	3,2
M4	4,3
M5	5,3
M6	6,4
M8	8,4
M10	10,5
M12	13
M16	17
M20	21
M24	26

Aluminium terminals 16 - 1200 mm²

- Used for connecting Al conductors to Al busbar.
- Two crimps are needed - For crimp sequence, see image.

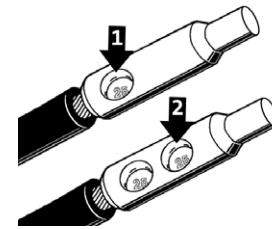
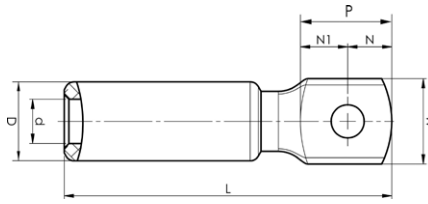

Crimp sequence



Stranded Al mm ²	Solid Al mm ²	AWG/MCM	AWG Al (Solid Al)	Name	Screw	W mm	d	D	N	N1	P	L	t	s	Tool	Pcs/pack
16	25	6	4	AK16-6	M6	16	5,9	13	8,5	9	17,5	61	5	29	V600, V1300, V250	48
16	25	6	4	AK16-8	M8	16	5,9	13	8,5	9	17,5	61	5	29	V600, V1300, V250	48
25	35	4	2	AK25-6	M6	16	6,8	13	8,5	9	17,5	61	5	29	V600, V1300, V250	48
25	35	4	2	AK25-8	M8	16	6,8	13	8,5	9	17,5	61	5	29	V600, V1300, V250	48
35	50	2	1/0	AK35-6	M6	22	8,5	20	11	14	25	85	7,5	45	V1300, V250	24
35	50	2	1/0	AK35-8	M8	22	8,5	20	11	14	25	85	7,5	45	V1300, V250	24
50	70	1/0	2/0	AK50-8	M8	22	9,6	20	11	14	25	85	7,5	45	V1300, V250	24
50	70	1/0	2/0	AK50-10	M10	22	9,6	20	11	14	25	85	7,5	45	V1300, V250	24
50	70	1/0	2/0	AK50-12	M12	27	9,6	20	14	15	29	90	6	45	V1300, V250	24
70	95	2/0	4/0	AK70-8	M8	22	11,3	20	11	14	25	85	7,5	45	V1300, V250	24
70	95	2/0	4/0	AK70-10	M10	22	11,3	20	11	14	25	85	7,5	45	V1300, V250	24
70	95	2/0	4/0	AK70-12	M12	27	11,3	20	14	15	29	90	6	45	V1300, V250	24
95	120	4/0	250	AK95-8	M8	27	12,5	25	14	15	29	104	10,5	60	V1300, V250	24
95	120	4/0	250	AK95-10	M10	27	12,5	25	14	15	29	104	10,5	60	V1300, V250	24
95	120	4/0	250	AK95-12	M12	27	12,5	25	14	15	29	104	10,5	60	V1300, V250	24
120	150	250	300	AK120-10	M10	27	14	25	14	15	29	104	10,5	60	V1300, V250	24
120	150	250	300	AK120-12	M12	27	14	25	14	15	29	104	10,5	60	V1300, V250	24
150	185	300	350	AK150-10	M10	27	15,8	25	14	15	29	104	10,5	60	V1300, V250	24
150	185	300	350	AK150-12	M12	27	15,8	25	14	15	29	104	10,5	60	V1300, V250	24
150	185	300	350	AK150-16	M16	35	15,8	25	21	23	44	119	8	60	V1300, V250	12
185	240	350	500	AK185-10	M10	35	17,6	32	16	18,5	34,5	113	13	61	V1300, V250	12
185	240	350	500	AK185-12	M12	35	17,6	32	16	18,5	34,5	113	13	61	V1300, V250	12
185	240	350	500	AK185-16	M16	35	17,6	32	16	18,5	34,5	113	13	61	V1300, V250	12
240		500		AK240-12	M12	35	19,8	32	16	18,5	34,5	113	13	61	V1300, V250	12
240		500		AK240-16	M16	35	19,8	32	16	18,5	34,5	113	13	61	V1300, V250	12
	300		600	AK300-12SOLID	M12	41	20	36	18	25	43	154	14	83	V250	6
	300		600	AK300-16SOLID	M16	41	20	36	18	25	43	154	14	83	V250	6
300		600		AK300-12	M12	41	22	36	18	25	43	154	14	83	V250	6
300		600		AK300-16	M16	41	22	36	18	25	43	154	14	83	V250	6
300		600		AK300-20	M20	41	22	36	20	23	43	154	15	83	V250	6
400		750		AK400-12	M12	41	25	40	18	25	43	155	15	83	V250	6
400		750		AK400-16	M16	41	25	40	18	25	43	155	15	83	V250	6
400		750		AK400-20	M20	41	25	40	20	23	43	155	15	83	V250	6
500		1000		AK500A-16	M16	55	28	52	26	29	55	225	20	110	V250	1
500		1000		AK500A-20	M20	55	28	52	26	29	55	225	20	110	V250	3
500		1000		AK500A-1		55	28	52			80	250	20	110	V250	3
500		1000		AK500A-2		70	28	52			80	250	16	110	V250	3
500		1000		AK500B-16	M16	44	28	44	22	22	44	174	16	83	V250	3
500		1000		AK500B-20	M20	44	28	44	22	22	44	174	16	83	V250	3
500		1000		AK500B-1		44	28	44			80	210	16	83	V250	3
500		1000		AK500B-2		70	28	44			80	210	16	83	V250	3
630		1250		AK630A-1		55	32	52			80	250	20	110	V250	3
630		1250		AK630A-2		70	32	52			80	250	16	110	V250	3
800		1600		AK800-1		60	36	60			80	267	20	129	V1470	1
800		1600		AK800-2		75	36	60			80	275	17	129	V1470	1
1000		2000		AK1000-1		60	40	60			80	267	20	129	V1470	1
1000		2000		AK1000-2		75	40	60			80	275	17	129	V1470	1
1200		2500		AK1200		75	44	70			80	291	17	142	V1470	1

t = palm thickness, s = strip length

Aluminium through connectors with partition 16 - 1200 mm²

- Used primarily for connecting two Al conductors with the same area.
- Two plus two crimps are needed - For crimp sequence, see image.
- Partition in the middle to prevent fluid flow.

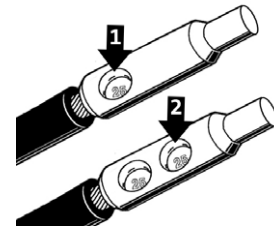
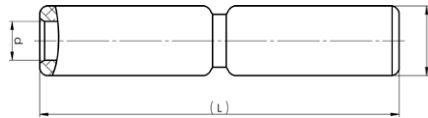

Crimp sequence

Stranded Al mm ²	Solid Al mm ²	AWG Al (Stranded Al)	AWG Al (Solid Al)	Name	d mm	D	L	s	Tool	Pcs/ pack
16-25		6-4		AS1625	6,2	11,5	35	18	V600	50
16	25	6	4	AS16	5,9	13	67	29	V600, V1300, V250	48
25	35	4	2	AS25	6,8	13	67	29	V600, V1300, V250	48
35	50	2	1/0	AS35	8,5	20	100	45	V1300, V250	24
50	70	1/0	2/0	AS50	9,6	20	100	42,5	V1300, V250	24
70	95	2/0	3/0	AS70	11,3	20	100	42,5	V1300, V250	24
95	120	3/0	250	AS95	12,5	25	130	57	V1300, V250	12
120	150	250	300	AS120	14	25	130	57	V1300, V250	12
150	185	300	350	AS150	15,8	25	130	58	V1300, V250	12
185	240	350	500	AS185	17,6	32	131	58	V1300, V250	9
240		500		AS240	19,8	32	131	58	V1300, V250	9
	300		600	AS300SOLID	20	36	177	83	V250	6
300		600		AS300	22	36	177	83	V250	3
400		750		AS400	25	40	179	83	V250	3
	400		750	AS400SOLID	23	40	179	83	V250	3
500		1000		AS500A	28	52	250	110	V250	3
500		1000		AS500B	28	44	184	83	V250	3
630		1250		AS630A-1	32	52	250	110	V250	1
630		1250		AS630A-2	34	52	250	110	V250	1
800		1600		AS800-1	36	60	288	129	V1470	1
1000		2000		AS1000-1	40	60	288	129	V1470	1
1200		2500		AS1200	44	70	320	142	V1470	1

For other combinations, please contact Elpress. s = strip length



Through connectors with aluminium partitions with different areas 16 - 400 mm²

- Used for connecting Al conductors of different areas.
- Two plus two crimps are needed - crimp sequence see picture.
- With partition.

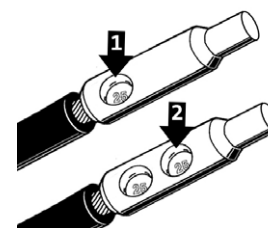
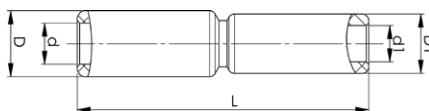

Crimp sequence

Stranded Al mm ²	Solid Al mm ²	AWG/MCM	AWG Al (Solid Al)	Name	d mm	d1	D	D1	L	s	s1	Tool	Pcs/pack
25-16	35-25	4-6	2-4	AS25-16	6,8	5,9	13	13	67	29	29	V1300, V250	48
35-25	50-35	2-4	1/0-4	AS35-25	8,5	6,8	20	13	85	45	29	V1300, V250	24
50-25	70-35	1/0-4	2/0-4	AS50-25	9,6	6,8	20	13	85	45	29	V1300, V250	24
50-35	70-50	1/0-2	2/0	AS50-35	9,6	8,5	20	20	100	45	45	V1300, V250	24
70-50	95-70	2/0-1/0	4/0-2/0	AS70-50	11,3	9,6	20	20	100	45	45	V1300, V250	24
95-25	120-35	4/0-4	2-250	AS95-25	12,5	6,8	25	13	101,1	60	29	V1300, V250	24
95-35	120-50	4/0-2	1/0-250	AS95-35	12,5	8,5	25	20	116	60	45	V1300, V250	24
95-50	120-70	3/0-1/0	250-2/0	AS95-50	12,5	9,6	25	20	116,1	60	45	V1300, V250	24
95-70	120-95	4/0-2/0	250-4/0	AS95-70	12,5	11,3	25	20	116,1	60	45	V1300, V250	24
120-95	150-120	250-4/0	300-250	AS120-95	14	12,5	25	25	130	60	60	V1300, V250	12
150-50	185-70	250-1/0	350-2/0	AS150-50	15,8	9,6	25	20	116,1	60	45	V1300, V250	12
150-70	185-95	300-2/0	350-3/0	AS150-70	15,8	11,3	25	20	116,1	60	45	V1300, V250	24
150-95	185-120	300-4/0	350-250	AS150-95	15,8	12,5	25	25	130	60	60	V1300, V250	12
150-120	185-150	300-250	350-300	AS150-120	15,8	14	25	25	130	60	60	V1300, V250	12
185-95	240-120	350-4/0	500-250	AS185-95	17,6	12,5	32	25	131,9	61	60	V1300, V250	12
185-150	240-185	350-300	500-350	AS185-150	17,6	15,8	32	25	131,9	61	60	V1300, V250	12
240-95	120	500-4/0	600-250	AS240-95	19,8	12,5	32	25	132	61	60	V1300, V250	12
240-120	150	500-250	300	AS240-120	19,8	14	32	25	132	61	60	V1300, V250	12
240-150	185	500-300	350	AS240-150	19,8	15,8	32	25	132	61	60	V1300, V250	12
240-185	240	500-350	500	AS240-185	19,8	17,6	32	32	131	61	61	V1300, V250	12
300-240		600-500		AS300-240	22	19,8	36	32	155,1	83	61	V250	6
400-300		750-600		AS400-300	25	22	40	36	179	83	83	V250	3

s, s1 = insulation stripping length

Aluminium through connectors with cable stop 300 - 400 mm²

- Used primarily for connecting two Al conductors with the same area
- For the indent crimping of Al-terminals, two crimps are always required, see image.

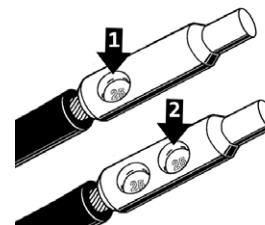
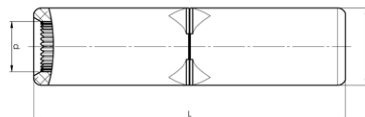

Crimp sequence

Stranded Al mm ²	AWG/MCM	Name	d mm	D	L	s	Tool	Pcs/pack
300	600	AS300B	22,5	37	150	65	V1300, V250	1
400	750	AS400B	25	37	150	64	V1300, V250	1

s = strip length



Aluminium-copper terminals 16 - 1200 mm²

- Used for connection of Al conductors for apparatus outlets and busbars of Cu.
- Two crimps are needed - For crimp sequence, see image.

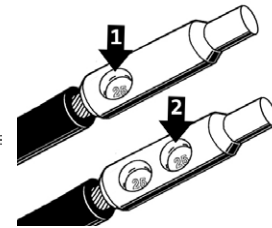
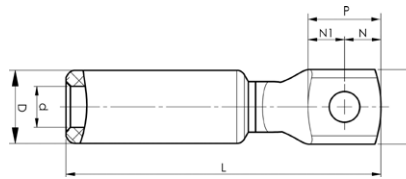
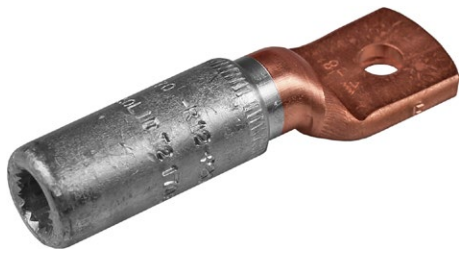

Crimp sequence

Stranded Al mm ²	Solid Al mm ²	AWG/ MCM	AWG Al (Solid Al)	Name	Screw	W mm	d	D	N	N1	P	L	t	s	Tool	Pcs/ pack
16	25 (16)	6	4	AKK16-8	M8	16	5,9	13	8,5	10	18,5	66	3	29	V600, V1300, V250	48
25	35	4	2	AKK25-8	M8	16	6,8	13	8,5	10	18,5	66	3	29	V600, V1300, V250	48
25	35	4	2	AKK25-12	M12	22	6,8	13	11,5	15,5	27	75	4	29	V600, V1300, V250	24
35	50	2	1/0	AKK35-8	M8	25	8,5	20	12,5	12,5	25	89	5,8	45	V1300, V250	24
35	50	2	1/0	AKK35-12	M12	25	8,5	20	12,5	12,5	25	89	5,8	45	V1300, V250	24
50	70	1/0	2/0	AKK50-8	M8	25	9,6	20	12,5	12,5	25	89	5,8	45	V1300, V250	24
50	70	1/0	2/0	AKK50-10	M10	25	9,6	20	12,5	12,5	25	89	5,8	45	V1300, V250	24
50	70	1/0	2/0	AKK50-12	M12	25	9,6	20	12,5	12,5	25	89	5,8	45	V1300, V250	24
70	95	2/0	4/0	AKK70-8	M8	25	11,3	20	12,5	12,5	25	89	5,8	45	V1300, V250	24
70	95	2/0	4/0	AKK70-10	M10	25	11,3	20	12,5	12,5	25	89	5,8	45	V1300, V250	24
70	95	2/0	4/0	AKK70-12	M12	25	11,3	20	12,5	12,5	25	89	5,8	45	V1300, V250	24
95	120	4/0	250	AKK95-8	M8	25,5	12,5	25	12,5	12,5	25	108	5,7	60	V1300, V250	12
95	120	4/0	250	AKK95-10	M10	25,5	12,5	25	12,5	12,5	25	108	5,7	60	V1300, V250	12
95	120	4/0	250	AKK95-12	M12	25,5	12,5	25	12,5	12,5	25	108	5,7	60	V1300, V250	12
95	120	4/0	250	AKK95-16	M16	30	12,5	25	15	15	30	115	6,5	60	V1300, V250	12
120	150	250	300	AKK120-10	M10	25,5	14	25	12,5	12,5	25	108	5,7	60	V1300, V250	12
120	150	250	300	AKK120-12	M12	25,5	14	25	12,5	12,5	25	108	5,7	60	V1300, V250	12
120	150	250	300	AKK120-16	M16	30	14	25	15	15	30	115	6,5	60	V1300, V250	12
150	185	300	350	AKK150-10	M10	25,5	15,8	25	12,5	12,5	25	108	5,7	60	V1300, V250	12
150	185	300	350	AKK150-12	M12	25,5	15,8	25	12,5	12,5	25	108	5,7	60	V1300, V250	12
150	185	300	350	AKK150-16	M16	30	15,8	25	15	15	30	115	6,5	60	V1300, V250	12
185	240	350	500	AKK185-10	M10	30	17,6	32	15	15	30	116	6,5	60	V1300, V250	12
185	240	350	500	AKK185-12	M12	30	17,6	32	15	15	30	116	6,5	60	V1300, V250	12
185	240	350	500	AKK185-16	M16	30	17,6	32	15	15	30	116	6,5	60	V1300, V250	12
240		500		AKK240-10	M10	30	19,8	32	15	15	30	116	6,5	61	V1300, V250	12
240		500		AKK240-12	M12	30	19,8	32	15	15	30	116	6,5	61	V1300, V250	12
240		500		AKK240-16	M16	30	19,8	32	15	15	30	116	6,5	61	V1300, V250	12
300		600		AKK300-12	M12	37	22	36	18,5	18,5	37	154	6,5	82	V250	6
300		600		AKK300-16	M16	37	22	36	18,5	18,5	37	154	6,5	82	V250	6
300		600		AKK300-20	M20	37	22	36	18,5	18,5	37	154	6,5	82	V250	6
	300		600	AKK300-12SOLID	M12	37	20	36	18,5	18,5	37	154	6,5	82	V250	6
	300		600	AKK300-16SOLID	M16	37	20	36	18,5	18,5	37	154	6,5	82	V250	6
	300		600	AKK300-20SOLID	M20	37	20	36	18,5	18,5	37	154	6,5	82	V250	6
400		750		AKK400-12	M12	37	25	40	18,5	18,5	37	155	6,5	83	V250	6
400		750		AKK400-16	M16	37	25	40	18,5	18,5	37	155	6,5	83	V250	6
400		750		AKK400-20	M20	37	25	40	18,5	18,5	37	155	6,5	83	V250	6
500		1000		AKK500A-16	M16	48	28	52	26	29	55	222	9,5	110	V250	3
500		1000		AKK500A-20	M20	48	28	52	26	29	55	222	9,5	110	V250	3
500		1000		AKK500A-1		48	28	52			70	237	9,5	110	V250	3
500		1000		AKK500A-2		70	28	52			70	240	12	110	V250	3
500		1000		AKK500B-16	M16	42	28	44	21	21	42	174	10	83	V250	3
500		1000		AKK500B-20	M20	42	28	44	21	21	42	174	10	83	V250	3
500		1000		AKK500B-1		42	28	44			70	202	10	83	V250	3
500		1000		AKK500B-2		70	28	44			70	211	12	83	V250	3
630		1250		AKK630A-1		48	32	52			70	237	9,5	110	V250	3
630		1250		AKK630A-2		70	32	52			70	240	12	110	V250	3
800		1600		AKK800-1		62	36	60			70	263	12	129	V1470	1
800		1600		AKK800-2		75	36	60			75	275	17	129	V1470	1
1000		2000		AKK1000-1		62	40	60			70	263	12	129	V1470	1
1000		2000		AKK1000-1-16	M16	62	40	60	30	40	70	263	12	129	V1470	1
1000		2000		AKK1000-2		75	40	60			75	275	17	129	V1470	1
1200		2500		AKK1200		75	44	70			75	310	17	142	V1470	1

s = strip length, t = palm thickness

Aluminium-copper terminals 300 - 400 mm²

- Used for connection of Al conductors for apparatus outlets and busbars of Cu, etc.
- For stranded wire Al conductor.
- Two crimps are needed, see image.

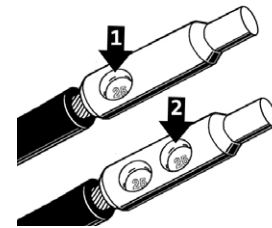
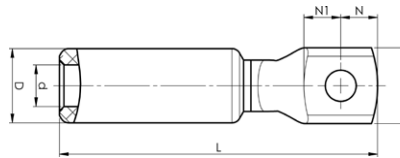

Crimp sequence

Stranded Al mm ²	AWG/MCM	Name	Screw	W mm	d	D	N	N1	L	t	s	Tool	Pcs/pack
300	600	AKK300B-12	M12	37	22,3	37	18,5	18,5	139	6,7	68	V1300, V250	6
300	600	AKK300B-16	M16	37	22,3	37	18,5	18,5	139	6,7	68	V1300, V250	6
400	750	AKK400B-12	M12	37	25	37	18,5	18,5	139	6,7	68	V1300, V250	6
400	750	AKK400B-16	M16	37	25	37	18,5	18,5	139	6,7	68	V1300, V250	6

t = palm thickness, s = strip length

05

Aluminium-copper pin sockets 16 - 300 mm²

- Used for connection of Al conductors to apparatus with copper connectors.
- Two crimps are needed - For crimp sequence, see image.

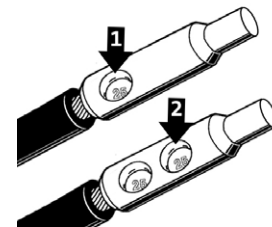
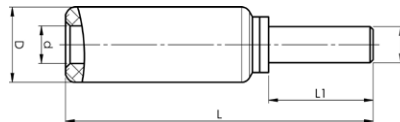

Crimp sequence

Stranded Al mm ²	Solid Al mm ²	AWG/MCM	AWG Al (Solid Al)	Name	d mm	D	e	L	L1	s	Tool	Pcs/pack
16	25 (16)	6	4	AKP16	5,9	13	6	56	25	29	V600, V1300, V250	48
25	35	4	2	AKP25	6,8	13	6	56	25	29	V600, V1300, V250	48
35	50	2	1/0	AKP35	8,5	20	9	78	25	45	V1300, V250	24
50	70	1/0	2/0	AKP50	9,6	20	9	88	35	45	V1300, V250	24
70	95	2/0	4/0	AKP70	11,3	20	9	88	35	45	V1300, V250	24
95	120	4/0	250	AKP95	12,5	25	12	103	35	60	V1300, V250	24
120	150	250	300	AKP120	14	25	12	108	40	60	V1300, V250	24
150	185	300	350	AKP150	15,8	25	12	108	40	60	V1300, V250	24
185	240	350	500	AKP185	17,6	32	14	113,5	45	61	V1300, V250	12
240		500		AKP240	19,8	32	14	113,5	45	61	V1300, V250	12
300		600		AKP300	22	36	16	142	50	83	V250	9

s = strip length

Through connectors of aluminium 16 - 95 mm² to solid copper 10 mm²

- Used for connecting stranded Al conductors to solid Cu conductors 10 mm²/8 AWG (e.g. Excel, Excelett).
- Two crimps are needed for both Al (crimp sequence see image) and Cu.

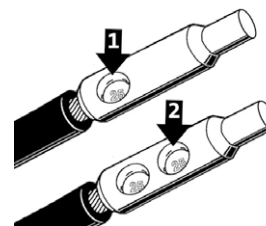
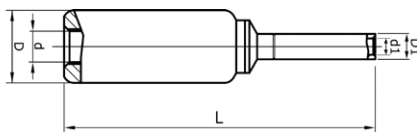

Crimp sequence

Stranded Al mm ²	Solid Al mm ²	mm ²	AWG	AWG Al (Solid Al)	Name	d	d1	D	D1	L	s	s1	Tool	Pcs/pack
16	25	10	6	4	AKS16-10S	5,9	4,5	13	7	64,5	29	33	V600, V1300, V250	48
25	35	10	4	2	AKS25-10S	6,8	4,5	13	7	64,5	29	33	V600, V1300, V250	48
35	50	10	2	1/0	AKS35-10S	8,5	4,5	20	7	86	45	33	V1300, V250	48
50	70	10	1/0	2/0	AKS50-10S	9,6	4,5	20	7	86	45	33	V1300, V250	24
70	95	10	2/0	4/0	AKS70-10S	11,3	4,5	20	7	86	45	33	V1300, V250	24
95	120	10	4/0	250	AKS95-10S	12,5	4,5	25	7	101	60	33	V1300, V250	24

s = strip length (Al), s1 = strip length (Cu)

Through connectors of aluminium-copper 300 - 400 mm²

- Used for connecting Al conductors and Cu conductors
- Stranded/solid Al conductors, stranded/flexible Cu conductors.
For multi-stranded Cu conductors, contact crimping using the DUAL system is recommended.
- Two crimps are needed for Al (see image).
- When crimping the Al part, use matrix P2537M and punch P2537D, no matrix holder is needed.
- When crimping the Cu part, place the dies between the marking on the sleeve and the edge of the Cu part.

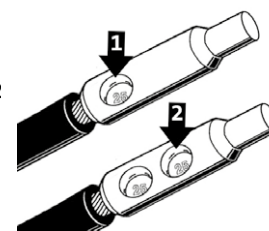
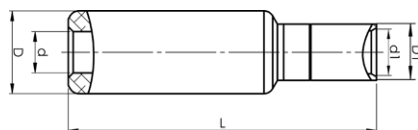

Crimp sequence

Stranded Al mm ²	mm ² (Cu)	AWG Al (Stranded)	AWG Cu	Name	d	d1	D	D1	L	s	s1	Tool	Pcs/pack
300	185	600	350	AKS300B-185	22,3	21	37	27	126,5	68	40	DV1300, DV250	6
300	240	600	500	AKS300B-240A	22,3	22,5	37	29	126,5	68	40	DV1300, DV250	6
400	240	750	500	AKS400B-240A	25	22,5	37	29	126,5	68	40	DV1300, DV250	6
400	300	750	600	AKS400B-300A	25	24,5	37	31,5	127	68	40	DV1300, DV250	6

If class 5 Cu conductors are used, use the corresponding DUAL tool for (D)V1300 or (D)V250., s = strip length (Al), s1 = strip length (Cu)



Aluminium-copper through connectors 16 - 400 mm²

- Connector from Al conductor to Cu conductor.
- Stranded/solid Al conductors, stranded/multi-stranded Cu conductors.
- For multi-stranded Cu conductors, contact crimping using the DUAL system is recommended.
- Two crimps are required for Al (see image) normally one for Cu.
- When hexagonally crimping the Cu part, the dies are placed between the marking groove and the outer edge.

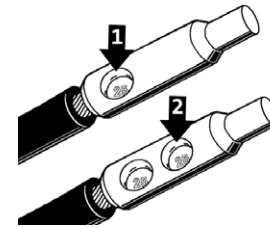
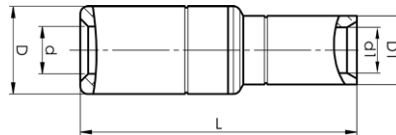
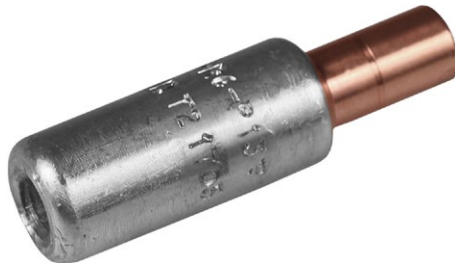

Crimp sequence

Stranded Al mm ²	Solid Al mm ²	Cu mm ²	AWG/MCM	AWG Al (Solid Al)	AWG Cu (AlCu)	Name	d	d1	D	D1	L	s	s1	Tool	Pcs/pack
16-25		10-16	6-4		8-6	AKS1625-1016	6,2	6	8,3	7,5	36,5	19	17	V600	48
16	25 (16)	10	6	4	8	AKS16-10	5,9	5	13	8	45,5	29	14	V600, DV1300, DV250	48
25	35	10	4	2	8	AKS25-10	6,8	5	13	8	45,5	29	14	V600, DV1300, DV250	48
25	35	16	4	2	6	AKS25-16	6,8	6	13	9	45,5	29	15	V600, DV1300, DV250	48
35	50	10	2	1/0	8	AKS35-10	8,5	5	20	8	66	45	14	DV1300, DV250	24
35	50	16	2	1/0	6	AKS35-16	8,5	6	20	13	66	45	15	DV1300, DV250	24
35	50	25	2	1/0	4	AKS35-25	8,5	8	20	13	69	45	17	DV1300, DV250	24
50	70	10	1/0	2/0	8	AKS50-10	9,6	5	20	13	66	45	14	DV1300, DV250	24
50	70	16	1/0	2/0	6	AKS50-16	9,6	6	20	13	66	45	15	DV1300, DV250	24
50	70	25	1/0	2/0	4	AKS50-25	9,6	8	20	13	69	45	17	DV1300, DV250	24
50	70	35	1/0	2/0	2	AKS50-35	9,6	9	20	13	71	45	19	DV1300, DV250	24
50	70	50	1/0	2/0	1/0	AKS50-50	9,6	11	20	14,5	75,5	45	23	DV1300, DV250	24
70	95	35	2/0	4/0	2	AKS70-35	11,3	9	20	13	71	45	19	DV1300, DV250	24
70	95	50	2/0	4/0	1/0	AKS70-50	11,3	11	20	14,5	75,5	45	23	DV1300, DV250	24
70	95	70	2/0	4/0	2/0	AKS70-70	11,3	13	20	17	78	45	25	DV1300, DV250	24
95	120	10	4/0	250	8	AKS95-10	12,5	5	25	17	81	60	14	DV1300, DV250	24
95	120	16	4/0	250	6	AKS95-16	12,5	6	25	17	81	60	15	DV1300, DV250	24
95	120	25	4/0	250	4	AKS95-25	12,5	8	25	17	84	60	17	DV1300, DV250	24
95	120	35	4/0	250	2	AKS95-35	12,5	9	25	17	86	60	19	DV1300, DV250	24
95	120	50	4/0	250	1/0	AKS95-50	12,5	11	25	17	90,5	60	23	DV1300, DV250	24
95	120	70	4/0	250	2/0	AKS95-70	12,5	13	25	17	93	60	25	DV1300, DV250	24
95	120	95	4/0	250	4/0	AKS95-95	12,5	15	25	20	93,5	60	25	DV1300, DV250	24
120	150	50	250	300	1/0	AKS120-50	14	11	25	17	90,5	60	23	DV1300, DV250	24
120	150	70	250	300	2/0	AKS120-70	14	13	25	17	93	60	25	DV1300, DV250	24
120	150	95	250	300	4/0	AKS120-95	14	15	25	20	93,5	60	25	DV1300, DV250	24
120	150	120	250	300	250	AKS120-120	14	17	25	22	103,5	60	30	DV1300, DV250	24
150	185	25	300	350	4	AKS150-25	15,8	8	25	17	84	60	17	DV1300, DV250	24
150	185	35	300	350	2	AKS150-35	15,8	9	25	17	86	60	19	DV1300, DV250	24
150	185	50	300	350	1/0	AKS150-50	15,8	11	25	17	90,5	60	23	DV1300, DV250	24
150	185	70	300	350	2/0	AKS150-70	15,8	13	25	17	93	60	25	DV1300, DV250	24
150	185	95	300	350	4/0	AKS150-95	15,8	15	25	20	93,5	60	25	DV1300, DV250	24
150	185	120	300	350	250	AKS150-120	15,8	17	25	22	103,5	60	30	DV1300, DV250	24
150	185	150	300	350	300	AKS150-150	15,8	19	25	25	99	60	30	DV1300, DV250	24
185	240	70	350	500	2/0	AKS185-70	17,6	13	32	17	93,5	61	25	DV1300, DV250	12
185	240	95	350	500	4/0	AKS185-95	17,6	15	32	20	94	61	25	DV1300, DV250	12
185	240	120	350	500	250	AKS185-120	17,6	17	32	22	104	60	30	DV1300, DV250	12
185	240	150	350	500	300	AKS185-150	17,6	19	32	25	99,5	61	30	DV1300, DV250	12
185	240	185	350	500	350	AKS185-185	17,6	21	32	27	100	61	30	DV1300, DV250	12
240		35	500		2	AKS240-35	19,8	9	32	17	86,5	61	19	DV1300, DV250	12
240		50	500		1/0	AKS240-50	19,8	11	32	17	91	61	23	DV1300, DV250	12
240		70	500		2/0	AKS240-70	19,8	13	32	17	93,5	61	25	DV1300, DV250	12
240		95	500		4/0	AKS240-95	19,8	15	32	20	93,5	61	25	DV1300, DV250	12
240		120	500		250	AKS240-120	19,8	17	32	22	104	60	30	DV1300, DV250	12
240		150	500		300	AKS240-150	19,8	19	32	25	99,5	60	30	DV1300, DV250	12
240		185	500		350	AKS240-185	19,8	21	32	27	100	61	30	DV1300, DV250	12
240		240	500		500	AKS240-240A	19,8	22,5	32	29	100	61	30	DV1300, DV250	12
300		150	600		300	AKS300-150	22	19	36	25	122,5	83	30	DV250	9
300		185	600		350	AKS300-185	22	21	36	27	123	83	30	DV250	9
300		240	600		500	AKS300-240A	22	22,5	36	29	123,5	83	30	DV250	9
	300	300		600	600	AKS300SOLID-300	20	26	36	32	124	83	30	DV250	6
400		150	750		300	AKS400-150	25	19	40	25	124	83	30	DV250	6
400		185	750		350	AKS400-185	25	21	40	27	124	83	30	DV250	6
400		240	750		500	AKS400-240A	25	22,5	40	29	124	83	30	DV250	6
400		300	750		600	AKS400-300A	25	24,5	40	31,5	125	83	30	DV250	6

s = strip length (Al), s1 = strip length (Cu)

05

Tools for Cu, Al and AlCu terminals

General information - Tools for Cu, Al and AlCu terminals	2
Crimp tool for Cu-terminals 4 - 25 mm ²	3
Crimp tools for Cu-terminals 6 - 120 mm ²	5
Battery-powered crimp tool for Cu-terminals 4 - 95 mm ²	6
Crimp tool for Cu-terminals 10 - 240 mm ² , Al-terminals 16 - 25 mm ² (-35 solid) mm ² and C-sleeves 100 mm ² (total)	9
Accessories for crimping Cu with T2600, V600, V611 and PVX611	11
Accessories for crimping Al with T2600, V600, V611 and PVX611	14
DUAL SYSTEM for crimping flexible conductors in KRF/KSF terminals for demanding applications 10-400 mm ²	15
Accessories for crimping Cu flexible conductors with DUAL system	18
Tools for Cu-terminals 10 - 400 mm ² , Al-terminals 16 - 400 mm ² and C-sleeves 6 - 240 mm ² (total area)	20
Accessories for crimping Cu with V1300, V1311-A and PVX1300	22
Accessories for crimping Al with V1300, V1311-A and PVX1300	28
Accessories for crimping overhead lines with V1300, V1311-A and PVX1300	31
Tools for Cu terminals 10 - 400 mm ² and C sleeves 240 mm ² (total)	32
Table stand for Cu- and Al-terminals	33
Accessories for crimping Cu with V1300C2, V1311C2-A and PVX1300C2	34
Tools for Cu terminals 10 - 800 mm ² , Al terminals 16 - 630 mm ² and C-sleeves 6 - 300 mm ²	39
Accessories for crimping Cu with V250	40
Accessories for crimping Al with V250	44
Accessories for crimping overhead lines with V250	46
Crimp station for industrial crimping of KRF/KSF terminals 10 - 300 mm ²	48
Analyzer - software for analysis of crimps and system calibration	50
Tools for Cu-terminals 500 - 1000 mm ² and Al-terminals 800 - 1200 mm ²	51
Lightweight and versatile designed pumps based on customer needs	54
Hydraulic foot pump	58

General information - Tools for Cu, Al and AlCu terminals



System Elpress

System Elpress consists of terminals and tools that are designed and tested together to give a certified crimping result. This ensures that users will feel confident when using our systems, and that a secure connection will be achieved through the proper handling of our products.

Hydraulic crimp systems

Elpress hydraulic crimp systems crimp from 10 to 1200 mm². The systems consist of pumps and crimp heads that can be freely combined or with complete hand-held tools, where these devices are integrated. Wide range of accessories available for crimping, pre-rounding, cutting etc. Together with the matching terminals, the complete system is formed. Both pumps and hand-held tools have, with a few exceptions, quick feed function that means crimping can begin after a few pump strokes. The systems have a built-in ratchet lock that ensures that an initial crimp is completed and thus produces results with the best characteristics. Pumps that can be connected to the different crimp heads provide the option of comfortable work in difficult situations and with maximum flexibility.



Crimp head V1300C2
Die pair 13DCB20. with dies.

Cu-terminals

The V1300 system is used for crimping Cu-terminals 10-400 mm². An open-head C version is also available for better access in confined spaces.



Al-terminals

The V1300 system is used for the indent crimping of Al connections and pre-rounding of Al conductors 16-240 mm². Round crimping is carried out on sector-shaped Al conductors.



Cu-terminals

The V250 system is used for crimping Cu-terminals 10-800 mm².



Al-terminals

The V250 system is used for indent crimping Al-terminals and pre-rounding Al conductors 16-630 mm². Round crimping is carried out on sector-shaped Al conductors.



Crimp tool for Cu-terminals 4 - 25 mm²

Properties:

- certified tool for connection according to norms
- ergonomic handles facilitate installation
- scissor movement for access in confined spaces
- ratchet function that does not release until the crimp is complete
- hexagonal crimping with clearly marked crimping positions



ES2258



Tested and certified mechanical hand-held tool for crimping Cu-terminals, type CUT 6-16 mm² and KR/KS 4-10 mm².

mm ²	AWG	Name	Crimp geometry	Net weight (kg)	Length mm	Width	Height
4-16	12-6	ES2258	Hexagonal	0,66	300	30	70

Crimp geometry



EL2258



Tested and certified mechanical hand-held tool for crimping Cu-terminals, type KRF/KSF 16-25 mm².

mm ²	AWG	Name	Crimp geometry	Net weight (kg)	Length mm	Width	Height
16-25	5-3	EL2258	Hexagonal	0,66	300	30	70

Crimp geometry



T2258



Tested and certified mechanical hand-held tool for crimping Cu-terminals, type CUT 6-16 mm² and KR/KRF/KS/KSF 4-16 mm².

mm ²	AWG	Name	Crimp geometries	Net weight (kg)	Length mm	Width	Height
4-16	12-6	T2258	Punch, Hexagonal	0,65	304	30	70

Crimp geometries





ES2288



Tested and certified mechanical hand-held tool for crimping Cu-terminals, type KRT/KST 10-25 mm².

mm ²	AWG	Name	Crimp geometry	Net weight (kg)	Length mm	Width	Height
10-25	8-4	ES2288	Hexagonal	0,654	300	30	70

Crimp geometry



EW1025



Tested and certified mechanical hand-held tool for crimping Cu-terminals 10-16 mm² and Al 16-25 mm².

mm ² (Cu)	AWG/ MCM (Cu)	mm ² (Stranded Al)	AWG Al (Stranded)	Name	Crimp geometry	Net weight (kg)	Length	Width	Height
10-16	8-6	16-25	6-4	EW1025	Punch	0,678	300	30	70

Crimp geometry



Crimp tools for Cu-terminals 6 - 120 mm²



T3165

Mechanical hand-held tool for crimping Cu-terminals.

Properties:

- equipped with ratchet function
- crimp wheels, rolled steel, which provide high strength
- crimp force up to approx. 35 kN

Crimp geometry



mm ²	Name	Crimp geometry	Net weight (kg)	Length mm	Width	Height	Used for
10-70	T3165A1	Punch	2,930	500	44	80	KR/KRF/KS/KSF
10-95	T3165B	Punch	2,939	500	44	80	KR/KRD/KS/KSD
10-95	T3165C	Punch	2,939	500	44	80	KR/KRT/KS/KST



TH series

Mechanical hand-held tool for crimping Cu-terminals, type KR/KRT and KS/KST, 6-120mm².

Properties:

- rotating crimping wheel
- no full closure mechanism
- crimp force up to approx. 35 kN

mm ²	Name	Crimp geometry	Net weight (kg)	Length mm	Width	Height
6-50	TH0650T	Hexagonal	1,339	400	44	80
10-120	TH10120T	Hexagonal	3,761	650	44	80

Crimp geometry



Battery-powered crimp tool for Cu-terminals 4 - 95 mm²



PVL350 - Elpress Mini



Battery-powered tool for crimping tube terminals and through connectors of type KR/KS, KRF/KSF, KRT/KST 10-70 mm² and KRD/KSD up to 95 mm² with special "MB" dies.

Properties:

- opening head for easy die changes and good accessibility
- high-performance 10.8 V Li-Ion battery with indication of charge status
- very good accessibility and ergonomics
- opening, rotatable "flip top" head for easy die changes and slim crimp head for good accessibility
- rapid crimp sequence 3-4 seconds
- approx. 100-180 crimps/battery charges (depending on temp, frequency etc.)
- 2-component housing with grip-friendly protection. One-handed operation for easy control of all tool functions
- lightweight, and rapid crimping sequence for maximum efficiency
- automatic return of the dies when crimping is complete

Crimp geometries

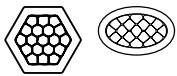

mm ² (Cu)	Name	Crimp geometry	Net weight (kg)	Length mm	Width	Height	Note
4-95	PVL350	Hexagonal, Oval	1,6	360	116	75	Charger: 230VAC
4-95	PVL350-US	Punch, Hexagonal, Oval	1,6	360	116	75	Charger: 115VAC
4-95	PVL350-WOBC	Punch, Hexagonal, Oval	1,1	360	116	75	without Battery/ Charger



Accessories for PVL350

Crimp dies for PVL350 (KR/KRF, KS/KSF, CUT, C-sleeves)

Supplied in pairs.

For hexagonal crimping of Cu 4-70 mm², class 2, 5 and 6 conductors acc. IEC 60228, CUT sleeves 6-16 mm² crimped with MB4016.

C-sleeves 6-25 mm² are crimped with MBC5 and MBC6.



Die pair MB11 for PVL350.



Die pair MBC5 for PVL350

Through conductor mm ²	Branching mm ²	mm ² KR/KS, KRF/KSF	Name	Number of crimps	Net weight (kg)
		10	MB8	1	0,086
		16	MB9	2	0,085
		25	MB11	2	0,083
		35	MB13	2	0,081
		50	MB14,5	2	0,08
		70	MB17	3	0,075
		4-10, CUT 6-16	MB4016	1	0,082
6-16	6-16		MBC5	2	0,11
5-25	5-25		MBC6	2	0,11

Crimp dies for PVL350 (KRT/KST)

Supplied in pairs.

For hexagonal crimping of Cu (class 2) 10-70 mm².



Die pair MB11 for PVL350.

mm ² KRT/KST	Name	Number of crimps	Net weight (kg)
10	MB7	1	0,088
16	MB8,5	1	0,087
25	MB10	2	0,084
35	MB12	2	0,083
50	MB14	3	0,080
70	MB16	3	0,075

Crimp dies for PVL350 (KRD/KSD)

Supplied in pairs.

For hexagonal crimping of Cu (class 2) 10-95 mm².



Die pair MB11 for PVL350.

mm ² KRD/KSD	Name	Number of crimps	Net weight (kg)
10 / 16	MB8	1	0,086
25	MB9	2	0,085
35	MB11	2	0,083
50	MB12	2	0,083
70	MB14	3	0,080
95	MB17	3	0,075



Crimp tool for Cu-terminals 10 - 240 mm², Al-terminals 16 - 25 mm² (-35 solid) mm² and C-sleeves 100 mm² (total)



V600



Tested and certified crimp head for crimping Cu-terminals, type KR/KS 10 mm², KRF/KSF 16-150 mm², KRD/KSD 16-185 mm², KRT/KST 10-240 mm², Al-terminals 16-25 mm² (-35 solid), C-sleeves 6/6-50/50 mm², DIN 46235 10-95 mm².

Used in combination with foot pump P4000 or the electrically powered pump PS710 (battery powered version of PS710E is also available).

Properties:

- working pressure 63 MPa (630 bar)
- crimp force 55 kN
- robust fabric bag with room for 10 dies included

mm ² (Cu)	mm ² (Stranded Al)	mm ² (Solid Al)	Name	Crimp geometries	Net weight (kg)	Length mm	Width	Height
10-240	16-25	16-35	V600	Punch, Hexagonal, Oval	2,45	189	74	53

Crimp geometries

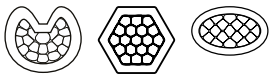

V611



Tested and certified hand-held tool for crimping Cu-terminals, type KR/KS 10 mm², KRF/KSF 16-150 mm², KRD/KSD 16-185 mm², KRT/KST 10-240 mm², Al-terminals 16-25 mm² (-35 solid), C-sleeves 6/6-50/50 mm², DIN 46235 10-95 mm².

Properties:

- fast-feed to crimp engagement provides short crimp times
- crimp force 55 kN
- delivered in sturdy textile bag

mm ² (Cu)	mm ² (Stranded Al)	mm ² (Solid Al)	Name	Crimp geometries	Net weight (kg)	Length	Width	Height
10-240	16-25	16-35	V611	Punch, Hexagonal, Oval	2,6	425	115	53

Crimp geometries

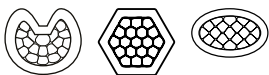



PVX611/PVX611DB



Tested and certified battery-powered crimp tool for crimping Cu-terminals, type KR/KS 10 mm², KRF/KSF 16-150 mm², KR/D/KSD 16-185 mm², KRT/KST 10-240 mm², Al-terminals 16-25 mm² (-35 solid), C sleeves 6/6-50/50 mm², DIN 46235 10-95 mm². PVX611DB has an extra battery.

Properties:

- protects against dirt and dust through the closed chassis
- ergonomic design ensures optimum balance in the user's hand
- swivel opening crimp fork
- crimp force control using pressure monitoring
- one handed operation for easy work
- LED lighting for easier work
- fast-forward feeding for more efficient crimping
- display with information about the tool and service intervals
- tested together with Elpress TB dies and KB22/KB25
- crimp monitoring via display when the correct pressure/complete crimping is not achieved (warning light LED and signal)

Crimp geometries

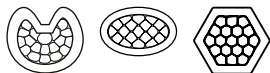

mm ² (Cu)	mm ² (Stranded Al)	mm ² (Solid Al)	Name	Crimp geometries	Net weight (kg)	Length mm	Width	Height	Note
10-150	16-25	16-35	PVX611	Punch, Oval, Hexagonal	5,50	414	116	75	Charger: 230VAC
10-150	16-25	16-35	PVX611DB	Punch, Oval, Hexagonal	5,85	414	116	75	Delivered with 2 batteries
10-150	16-25	16-35	PVX611-US	Punch, Oval, Hexagonal	5,50	414	116	75	Charger: 115VAC
10-150	16-25	16-35	PVX611-WOBC	Punch, Oval, Hexagonal	3,90	414	116	75	Without Battery/Charger



T2600



Mechanical hand-held tool for crimping Cu-terminals, type KR/KS 10 mm², KRF/KSF 16-95 mm², KR/D/KSD 16-120 mm², KRT/KST 10-120 mm², Al-terminals 16-25 mm² (-35 solid), and C-sleeves 6/6-50/50 mm², DIN 46235 10-95 mm².

Properties:

- opening for easy die changes and for quick removal after jointing
- crimp force approx. 57 kN
- advanced force ratio for lowest handle force
- easy to work with in confined spaces
- only four die pairs are required to crimp 10-95 mm² Cu
- quick feed function
- delivered in a metal box

mm ² (Cu)	mm ² (Solid Al)	Name	Crimp geometries	Net weight (kg)	Length mm	Width	Height
10-95	35	T2600	Punch, Hexagonal, Oval	1,9	445	185	52
10-120	35	T2600B	Punch, Hexagonal, Oval	4,12	445	185	52
10-120	35	T2600C	Punch, Hexagonal, Oval	4,12	445	185	52

Crimp geometries



Accessories for crimping Cu with tools T2600, V600, V611 and PVX611

Crimp dies for KRF/KSF

For Cu-terminals, hexagonal crimping. Supplied in pairs.
The TB dies below are intended for Cu-terminals, type KRF/KSF, together with Cu conductor according to IEC 60228 (class 2, 5 and 6).



Die pair TB7-20 for V600, V611, PVX611 and T2600.



Die pair KB22 for V600, V611 and PVX611.

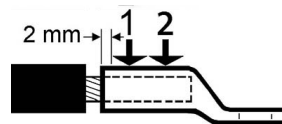

Crimp sequence for two crimps.

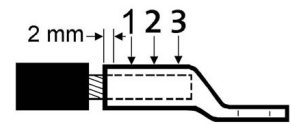

Crimp sequence for three crimps.

mm ² KR/KS, KRF/KSF	Name	Number of crimps	Net weight (kg)
10 / 70	TB8-17	1, 2	0,138
16 / 35	TB9-13	1	0,149
25 / 50	TB11-14,5	1	0,149
10 / 95	TB7-20	1, 2	0,135
120	KB22	3	0,150
150	KB25	3	0,147

KBxx is not allowed to be used with T2600

Crimp dies for KRD/KSD

For Cu-terminals, hexagonal crimping. Supplied in pairs.
The TB dies below are intended for Cu-terminals, type KRD/KSD, together with Cu conductor according to IEC 60228 (class 2).



Die pair TB7-20 for V600, V611, PVX611 and T2600.



Die pair KB22 for V600, V611 and PVX611.

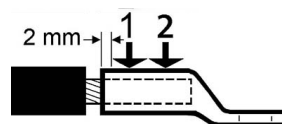

Crimp sequence for two crimps.

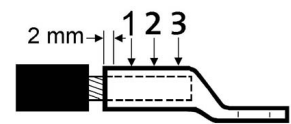

Crimp sequence for three crimps.

mm ² KRD/KSD	Name	Number of crimps	Net weight (kg)
16 / 70	TB8-14	1	0,149
25 / 50	TB9-12	1	0,150
35 / 95	TB11-16	1, 2	0,142
150	KB22	3	0,150
185	KB25	3	0,147

KBxx is not allowed to be used with T2600

Crimp dies for KRT/KST

For Cu-terminals, hexagonal crimping. Supplied in pairs.
The TB dies below are intended for Cu-terminals, type KRT/KST, together with Cu conductor according to IEC 60228 (class 2).



Die pair TB7-20 for V600, V611, PVX611 and T2600.



Die pair KB22 for V600, V611 and PVX611.

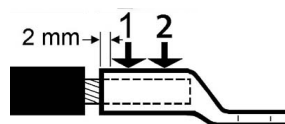

Crimp sequence for two crimps.

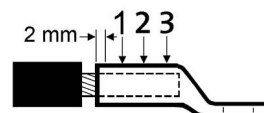

Crimp sequence for three crimps.

mm ² KRT/KST	Name	Number of crimps	Net weight (kg)
10 / 120	TB7-19	1, 2	0,137
16 / 95	TB8,5-18	1, 2	0,137
25 / 70	TB10-16	1, 2	0,143
35 / 50	TB12-14	1	0,147
150	KB22	3	0,150
185	KB24	3	0,144
240	KB26	3	0,145

KBxx is not allowed to be used with T2600

Crimp dies for overhead line

For joints on overhead lines AlMgSi (Super B) and Al59, hexagonal crimping. Supplied in pairs.

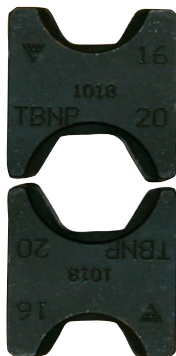

Die pair TBNP 16-20.

mm ² Overhead line	Name	Number of crimps	Net weight (kg)	Note
31 - 99	TBNP16-20	2x5, 2x10	0,135	Used for AlMgSi and FeAl, LFS31, LFS62 and LFS99



Crimp dies for C-sleeves

For Cu branching with C-sleeves, oval crimping. Supplied in pairs.



TBC89-B13

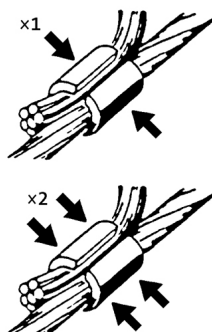

1 and 2 crimps.

Through conductor mm ²	Branching mm ²	mm ²	Name	Number of crimps	Net weight (kg)	Die holder required	Note
6-16 (C5) & 5-25 (C6)	6-16 (C5) & 5-25 (C6)	Total: 12-26 (C5), 30-50 (C6)	TBC5-C6	1	0,142	No	C5 (Sleeve: C6-10) and C6 (Sleeve: C16-25)
6-50	6-50	Total: 50-100 (C89)	TBC89-B13	2, 1	0,123	No	C89 (Sleeve: C25-50) and B13 (KRF/KSF: 35 mm ²)

06

Accessories for crimping Al with T2600, V600, V611 and PVX611

Punch and Matrix for Al

For Al-terminals, indent crimping. Not used for pre-rounding.

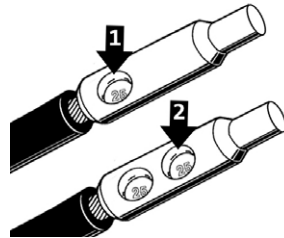

Matrix holder TV2620, matrix TP13M, punch TP13D.

Crimp sequence

Stranded Al mm ²	Solid Al mm ²	Matrix	Matrix holder	Punch	Number of crimps
16-25	16-35	TP13M	TV2620	TP13D	2

Two crimps are always needed.

Crimp dies for Al and Cu

For crimping 16-25 mm² Al and 10-16 mm² Cu. Rotatable die, one side for crimping aluminum and the other side for crimping copper. Used in the V600 system.



Punch crimping.

The dies below are intended to be used together with Cu/Al conductors according to IEC 60228.



Stranded Al mm ²	mm ² KR/KS, KRF/KSF	Name	Number of crimps	Net weight (kg)	Note
16-25	10-16	TBKA9-11,5	1	0,14	Used to crimp AS1625 and AKS1625-1016

DUAL SYSTEM for crimping flexible conductors in KRF/KSF terminals for demanding applications 10-400 mm²



Properties:

- patented crimping
- for crimping of flexible Cu conductors according to IEC 60228, type class 5
- used with Elpress KRF/KSF terminals
- for extra harsh environments such as cars and trains, where the terminals in addition to electrical properties are also exposed to, for example, corrosion, mechanical durability and vibration
- meets IEC/EN 61238:1
- meets corrosion requirements according to DIN V 40 046-37
- meets the requirements for vibration according to EN 50 155
- meets the requirements of mechanical strength according to SEN 24 50 10

Crimping sequence

Contact crimping takes place in a two-stage movement, first a hexagonal crimping that provides optimal symmetrical contact with the conductor, which means that no wires are broken or come apart in the edge facing the connector. This is followed by indent crimping, which provides 30% better electrical properties.

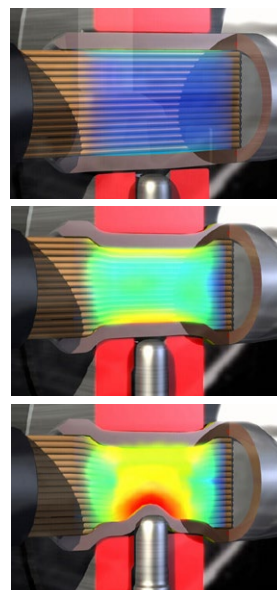

PVX1300/PVX1300DB

Tested and certified battery-powered crimp gun for contact crimping Cu-terminals, type KR/KRT 10 mm², KS/KST 10 mm², KRF/KRD/KRT 16-400 mm², KSF/KSD/KST 16-400 mm², Al-terminals 16-400 mm² (-240 solid), DIN 46235 10-300 mm², C sleeves up to 240 mm² total area (C95-120).

Properties:

- ergonomic design ensures optimum balance in the user's hand
- crimp monitoring with warning light and signal when the correct pressure/full crimp is not achieved
- LED work lighting
- possibility of documentation of each crimp for unique service control
- crimp force 124 kN (13 tonnes)
- crimps/charging: 60-120 depending on size and temperature
- crimp time: 4-12s depending on size
- usage temperature -20°C to +40°C
- Li-Ion Makita, 5.0 Ah, 18V
- charger Li-Ion Makita, charging time 22 min 110-240VAC 50-60Hz
- DUAL: 10 - 300 mm²



Crimp geometries



mm ² (Cu)	mm ² (Stranded Al)	mm ² (Solid Al)	Name	Crimp geometry	Net weight (kg)	Length mm	Width	Height	Note
10-400	16-400	16-240	PVX1300	Punch, Dual, Hexagonal, Oval	6,7	412	319	75	Delivered in standard case
10-400	16-400	16-240	PVX1300DB	Punch, Dual, Hexagonal, Oval	7,3	412	319	75	Delivered with 2 batteries
10-400	16-400	16-240	PVX1300-ADV	Punch, Dual, Hexagonal, Oval	14,2	412	319	75	Delivered in CASE ADV.
10-400	16-400	16-240	PVX1300DB-ADV	Punch, Dual, Hexagonal, Oval	14,2	412	319	75	Delivered with 2 batteries and CASE ADV.
10-400	16-400	16-240	PVX1300-WOBC-ADV	Punch, Dual, Hexagonal, Oval	12,4	412	319	75	Delivered in CASE ADV. and without Battery/Charger
10-300	16-400	16-240	PVX1300-US	Punch, Dual, Hexagonal, Oval	6,7	412	319	75	Delivered with battery and US-charger
10-300	16-400	16-240	PVX1300DB-US	Punch, Dual, Hexagonal, Oval	7,3	412	319	75	Delivered with 2 batteries and US-charger
10-400	16-400	16-240	PVX1300-WOBC	Punch, Dual, Hexagonal, Oval	4,8	412	319	75	Delivered without Battery/Charger



DV1300

Tested and certified crimp head with patented DUAL technology for crimping Cu-terminals, type KR/KRF and KS/KSF 10-300 mm². Used in combination with foot pump P4000 or the electrically powered pump PS710 (battery powered version of PS710E is also available).



Properties:

- crimp head with the patented DUAL technology that provides optimised hexagonal crimping + a certain amount of indent crimping in two integrated steps
- working pressure 63 MPa (630 bar)
- crimp force 130 kN
- no die holders are needed for DUAL dies
- other accessories (without DUAL function) for crimping both Cu and Al-terminals can be used
- DUAL: 10 - 300 mm²

mm ² (Cu)	mm ² (Stranded Al)	mm ² (Solid Al)	Name	Crimp geometries	Net weight (kg)	Length mm	Width	Height
10-400	16-400	16-240	DV1300	Punch, Dual, Hexagonal, Oval	3,34	265	74	75

Crimp geometries

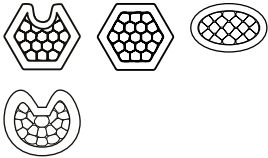

DV1300C2

Crimp head with patented DUAL technology for crimping Cu-terminals, type KR/KRF and KS/KSF 10-300 mm². Used in combination with foot pump P4000 or the electrically powered pump PS710 (battery powered version of PS710E is also available).



Properties:

- crimp head for the patented DUAL technology that provides optimised hexagonal crimping + a indent crimping in two integrated steps
- working pressure 63 MPa (630 bar)
- crimp force 130 kN
- no die holders are needed for DUAL dies
- other accessories (without DUAL function) for crimping Cu can be used
- DUAL: 10 - 300 mm²

mm ² (Cu)	Name	Crimp geometries	Net weight (kg)	Length mm	Width	Height
10-400	DV1300C2	Dual, Hexagonal, Oval	4,9	297	140	75

Crimp geometries



PVX1300C2/PVX1300C2DB

Tested and certified battery-powered crimp gun for crimping Cu-terminals, type Cu-terminals, type KR/KRT 10 mm², KS/KST 10 mm², KRF/KRD/KRT 16-400 mm², KSF/KSD/KST 16-400 mm², C-sleeves up to 240 mm² total area (C95-120).



Properties:

- ergonomic design ensures optimum balance in the user's hand
- crimp monitoring with warning light (LED) and signal when the correct pressure/ full crimp is not achieved
- LED work lighting
- possibility of documentation of each crimp for unique service control
- crimp force 124 kN (13 tonnes)
- usage temperature -20°C to +40°C
- Li-Ion Makita, 5.0 Ah, 18V
- charger Li-Ion Makita, charging time 22 min 110-240VAC 50-60Hz
- DUAL: 10 - 300 mm²



Crimp geometries

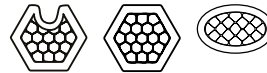

mm ² (Cu)	Name	Crimp geometry	Net weight (kg)	Length mm	Width	Height	Note
10-400	PVX1300C2	Dual, Hexagonal, Oval	7,5	399	319	75	Delivered in standard case
10-400	PVX1300C2DB	Dual, Hexagonal, Oval	8,1	399	319	75	Delivered with 2 batteries
10-400	PVX1300C2-ADV	Dual, Hexagonal, Oval	15,1	399	319	75	Delivered in CASE ADVANCED
10-400	PVX1300C2DB-ADV	Dual, Hexagonal, Oval	15,1	399	319	75	2 batteries and CASE ADV.
10-400	PVX1300C2-US	Dual, Hexagonal, Oval	5,6	399	319	75	With US charger
10-400	PVX1300C2DB-US	Dual, Hexagonal, Oval	6,2	399	319	75	Delivered with 2 batteries and US-charger
10-400	PVX1300C2-WOBC	Dual, Hexagonal, Oval	5,6	399	319	75	without Battery/Charger

90



DV250

Tested and certified crimp head with patented DUAL technology for crimping Cu-terminals, type KRF/KSF 120-400 mm². Used in combination with foot pump P4000 or the electrically powered pump PS710 (battery powered version of PS710E is also available).

Properties:

- crimp head with the patented DUAL technology that provides optimised hexagonal crimping + a certain amount of indent crimping in two integrated steps
- working pressure 63 MPa (630 bar)
- crimp force 250kN (25 tonnes)
- large crimp area
- no die holders are needed for DUAL dies
- Other accessories (without DUAL function) for crimping both Cu and Al-terminals can be used
- DUAL: 120 - 400 mm²



mm ² (Cu)	mm ² (Stranded Al)	mm ² (Solid Al)	Name	Crimp geometries	Net weight (kg)	Length mm	Width	Height
10-800	16-630	16-300	DV250	Punch, Dual, Hexagonal, Oval	4,8	280	111	74

Crimp geometries

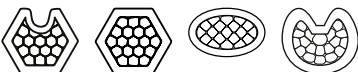

Accessories for crimping Cu flexible conductors with DUAL system DV1300, DV1300C2, PVX1300, PVX1300C2 and DV250

Crimp dies for DV1300 och PVX1300

Supplied in pairs.
For Cu-terminals, type KR/KRF and KS/KSF and flexible Cu conductors.
No die holders are needed.



Die pair 13DB20.

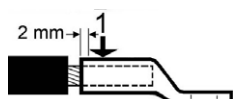

Crimp sequence for one crimp.

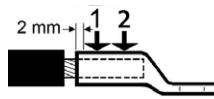

Crimp sequence for two crimps.

mm ²	Name	Number of crimps	Net weight (kg)
10	13DB8	1	0,448
16	13DB9	1	0,447
25	13DB11	1	0,462
35	13DB13	1	0,477
50	13DB14,5	1	0,480
70	13DB17	1	0,486
95	13DB20	1	0,484
120	13DB22	2	0,441
150	13DB25	2	0,440
185	13DB27	2	0,443
240	13DB30	2	0,453
300	13DB32	2	0,428

Crimp dies for DV1300C2 and PVX1300C2

Supplied in pairs.
For Cu-terminals, type KR/KRF and KS/KSF and flexible Cu conductors.
No die holders are needed.



Die pair 13DCB20.

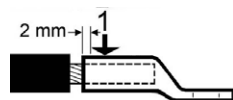

Crimp sequence for one crimp.

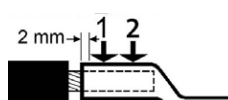

Crimp sequence for two crimps.

mm ²	Name	Number of crimps	Net weight (kg)
10	13DCB8	1	0,456
16	13DCB9	1	0,440
25	13DCB11	1	0,465
35	13DCB13	1	0,486
50	13DCB14,5	1	0,497
70	13DCB17	1	0,503
95	13DCB20	1	0,507
120	13DCB22	2	0,450
150	13DCB25	2	0,498
185	13DCB27	2	0,514
240	13DCB30	2	0,534
300	13DCB32	2	0,490



Crimp dies for DV250

Supplied in pairs.
 For Cu-terminals, type KR/KRF and KS/KSF and flexible Cu conductors.
 No die holders are needed.

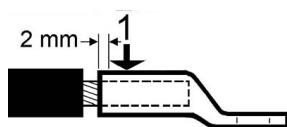

Crimp sequence for one crimp.

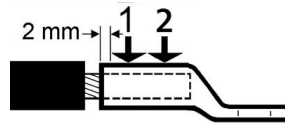

Crimp sequence for two crimps.

mm ²	Name	Number of crimps	Net weight (kg)
120	DB2522	1	1,060
150	DB2525	1	1,060
185	DB2527	1	1,060
240	DB2530	1	1,060
300	DB2532	1	1,060
400	DB2538	2	1,060

96

Tools for Cu-terminals 10 - 400 mm², Al-terminals 16 - 400 mm² and C-sleeves 6 - 240 mm² (total area)



V1300



Tested and certified crimp head for crimping Cu-terminals, type KR/KRT 10 mm², KS/KST 10 mm², KRF/KRD/KRT 16-400 mm², KSF/KSD/KST 16-400 mm², Al-terminals 16-400 mm² (-240 solid), DIN 46235 10-300 mm², C sleeves up to 240 mm² total area (C95-120). Used in combination with foot pump P4000 or the electrically powered pump PS710 (battery powered version of PS710E is also available).

Properties:

- working pressure 63 MPa (630 bar)
- crimp force 130 kN (13 tonnes)
- versatile and easy-to-use steel crimp head

mm ² (Cu)	mm ² (Stranded Al)	mm ² (Solid Al)	Name	Crimp geometries	Net weight (kg)	Length mm	Width	Height
10-400	16-400	16-240	V1300	Punch, Hexagonal, Oval	3,46	263	88	75

Crimp geometries

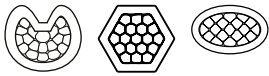

V1311-A



Tested and certified hydraulic hand-held tool for crimping Cu-terminals, type KR/KRT 10 mm², KS/KST 10 mm², KRF/KRD/KRT 16-400 mm², KSF/KSD/KST 16-400 mm², Al terminals 16-400 mm² (-240 solid), DIN 46235 10-300 mm², C-sleeves up to 240 mm² total area (C95-120).

Properties:

- fast forward feeding
- crimp force 130 kN (13 tonnes)
- requires low handle force, approx 245 N at max force
- the fork can rotate 180°

mm ² (Cu)	mm ² (Stranded Al)	mm ² (Solid Al)	Name	Crimp geometries	Net weight (kg)	Length mm	Width	Height
10-400	16-400	16-240	V1311-A	Punch, Hexagonal, Oval	4,3	588	150	74

Crimp geometries



PVX1300/PVX1300DB

Tested and certified battery-powered crimp gun for contact crimping Cu-terminals, type KR/KRT 10 mm², KS/KST 10 mm², KRF/KRD/KRT 16-400 mm², KSF/KSD/KST 16-400 mm², Al-terminals 16-400 mm² (-240 solid), DIN 46235 10-300 mm², C sleeves up to 240 mm² total area (C95-120).



Properties:

- ergonomic design ensures optimum balance in the user's hand
- crimp monitoring with warning light and signal when the correct pressure/full crimp is not achieved
- LED work lighting
- possibility of documentation of each crimp for unique service control
- crimp force 124 kN (13 tonnes)
- crimps/charging: 60-120 depending on size and temperature
- crimp time: 4-12s depending on size
- usage temperature -20°C to +40°C
- Li-Ion Makita, 5.0 Ah, 18V
- charger Li-Ion Makita, charging time 22 min 110-240VAC 50-60Hz
- DUAL: 10 - 300 mm²



Crimp geometries

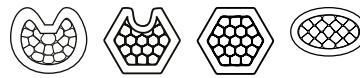

mm ² (Cu)	mm ² (Stranded Al)	mm ² (Solid Al)	Name	Crimp geometry	Net weight (kg)	Length mm	Width	Height	Note
10-400	16-400	16-240	PVX1300	Punch, Dual, Hexagonal, Oval	6,7	412	319	75	Delivered in standard case
10-400	16-400	16-240	PVX1300DB	Punch, Dual, Hexagonal, Oval	7,3	412	319	75	Delivered with 2 batteries
10-400	16-400	16-240	PVX1300-ADV	Punch, Dual, Hexagonal, Oval	14,2	412	319	75	Delivered in CASE ADVANCED
10-400	16-400	16-240	PVX1300DB-ADV	Punch, Dual, Hexagonal, Oval	14,2	412	319	75	Delivered with 2 batteries and CASE ADV.
10-400	16-400	16-240	PVX1300-WOBC-ADV	Punch, Dual, Hexagonal, Oval	12,4	412	319	75	Delivered in CASE ADV. and without Battery/Charger
10-300	16-400	16-240	PVX1300-US	Punch, Dual, Hexagonal, Oval	6,7	412	319	75	Delivered with battery and US-charger
10-300	16-400	16-240	PVX1300DB-US	Punch, Dual, Hexagonal, Oval	7,3	412	319	75	Delivered with 2 batteries and US-charger
10-400	16-400	16-240	PVX1300-WOBC	Punch, Dual, Hexagonal, Oval	4,8	412	319	75	Delivered without Battery/Charger

Accessories for crimping Cu with V1300, V1311-A and PVX1300

The B dies below are intended for Cu-terminals, type KR/KRF and KS/KSF, together with both stranded, multi-stranded and very flexible Cu conductors of Class 2, 5 and 6 respectively according to IEC 60228. For multi-stranded (Class 5) Cu conductors, crimping is recommended with the Dual system. KR/KSD and KRT/KST are only used for stranded (Class 2) Cu conductors.

Crimp dies for KRF/KSF

For Cu-terminals, hexagonal crimping. Supplied in pairs.
 The B dies below are intended for Cu-terminals, type KR/KRF and KS/KSF, together with Cu conductors according to IEC 60228. For multi-stranded (Class 5) and very flexible (Class 6) Cu conductors, crimping with the Dual system is recommended.
 Use inner die holder **V1316** and outer die holder **V1318**.



Outer die holder V1318, B-dies, inner die holder V1316.



Integrated dies 13B32.

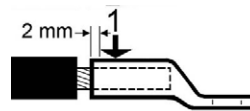

Crimp sequence for one crimp.

mm ²	Name	Number of crimps	Net weight (kg)
10	B8	1	0,101
16	B9	1	0,103
25	B11	1	0,109
35	B13	1	0,113
50	B14,5	1	0,111
70	B17	1	0,107
95	B20	1	0,115
120	B22	1	0,148
150	B25	1	0,135



Crimp dies for KRF/KSF (integrated)

For Cu-terminals, hexagonal crimping. Supplied in pairs.
 The integrated B dies below are intended for Cu-terminals, type KR/KRF and KS/KSF, together with Cu conductors according to IEC 60228.
 For multi-stranded (Class 5) and very flexible (Class 6) Cu conductors, crimping with the Dual system is recommended.
 Used without a die holder.



Integrated dies 13B32.

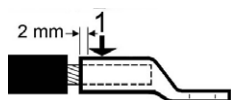

Crimp sequence for one crimp.

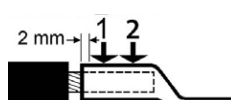

Crimp sequence for two crimps.

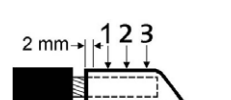

Crimp sequence for three crimps.

mm ²	Name	Number of crimps	Net weight (kg)
10	13B8	1	0,438
16	13B9	1	0,445
25	13B11	1	0,460
35	13B13	1	0,475
50	13B14,5	1	0,471
70	13B17	1	0,465
95	13B20	1	0,473
120	13B22	2	0,421
150	13B25	2	0,422
185	13B27	2	0,419
240	13B30	2	0,413
300	13B32	2	0,408
400	13B38	3	0,308

96

Crimp dies for KRD/KSD

For Cu-terminals, hexagonal crimping. Supplied in pairs.
 The B dies below are intended for Cu-terminals, type KRD and KSD, together with Cu conductors class 2 according to IEC 60228.
 Use inner die holder **V1316** and outer die holder **V1318**.



Outer die holder V1318, B-dies, inner die holder V1316.

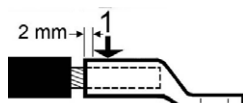

Crimp sequence for one crimp.

mm ² KRD/KSD	Name	Number of crimps	Net weight (kg)	Die holder required
16	B8	1	0,101	Yes
25	B9	1	0,103	Yes
35	B11	1	0,109	Yes
50	B12	1	0,108	Yes
70	B14	1	0,112	Yes
95	B16	1	0,107	Yes
120	B19	1	0,118	Yes
150	B22	1	0,148	Yes



Crimp dies for KRD/KSD (integrated)

For Cu-terminals, hexagonal crimping. Supplied in pairs.
The integrated B dies below are intended for Cu-terminals, type KRD and KSD, together with Cu conductors Class 2 according to IEC 60228. Used without a die holder.



Integrated dies 13B32.

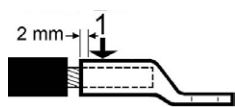

Crimp sequence for one crimp.

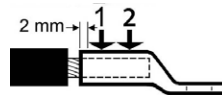

Crimp sequence for two crimps.

mm ² KRD/KSD	Name	Number of crimps	Net weight (kg)
16	13B8	1	0,438
25	13B9	1	0,445
35	13B11	1	0,460
50	13B12	1	0,457
70	13B14	1	0,471
95	13B16	1	0,466
120	13B19	1	0,476
150	13B22	2	0,421
185	13B25	2	0,422
240	13B27	2	0,419
300	13B30	2	0,413
400	13B32	2	0,408

Crimp dies for KRT/KST

For Cu-terminals, hexagonal crimping. Supplied in pairs.
The B dies below are intended for Cu-terminals, type KRT and KST, together with Cu conductors class 2 according to IEC 60228. Use inner die holder **V1316** and outer die holder **V1318**.



Outer die holder V1318, B-dies, inner die holder V1316.

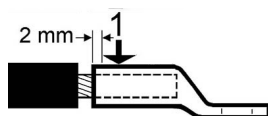

Crimp sequence for one crimp.

mm ² KRT/KST	Name	Number of crimps	Net weight (kg)
10	B7	1	0,101
16	B8,5	1	0,101
25	B10	1	0,106
35	B12	1	0,108
50	B14	1	0,112
70	B16	1	0,107
95	B18	1	0,120
120	B19	1	0,118
150	B22	1	0,148
185	B24	1	0,139



Crimp dies for KRT/KST (integrated)

For Cu-terminals, hexagonal crimping. Supplied in pairs.
The integrated B dies below are intended for Cu-terminals, type KRT and KST, together with Cu conductors Class 2 according to IEC 60228.
Used without a die holder.



Integrated dies 13B32.

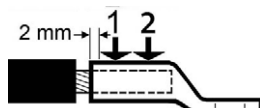

Crimp sequence for two crimps.

mm ² KRT/KST	Name	Number of crimps	Net weight (kg)
25	13B10	1	0,451
35	13B12	1	0,457
50	13B14	1	0,471
70	13B16	1	0,466
95	13B18	1	0,480
120	13B19	1	0,476
150	13B22	2	0,421
185	13B24	2	0,001
240	13B26	2	0,420
300	13B30	2	0,413
400	13B32	2	0,408

96

Crimp dies for C-sleeves

For Cu branching with C-sleeves, oval crimping.
Unless otherwise stated, use inner die holder V1316, and outer die holder V1318.

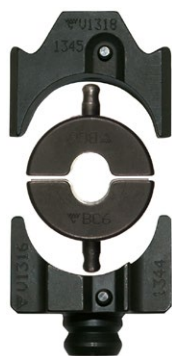

Outer die holder V1318,
BC dies, inner die holder V1316.

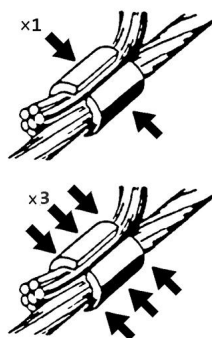

One and three crimps.

Through conductor mm ²	Branching mm ²	mm ²	Name	Number of crimps	Net weight (kg)	Die holder required
6-16	6-16	Total: 12-26	BC5	1	0,112	Yes
5-25	5-25	Total: 30-50	BC6	1	0,149	Yes
6-50	6-50	Total: 50-100	BC8-9	1	0,138	Yes
25-120	25-120	Total: 95-190	13BC13	3	0,410	
25-185	25-185	Total: 175-240	13BC15	3	0,404	



Die holders for the 1300 system

Outer and inner holder for the 1300 system.



Outer die holder V1318



Inner die holder V1316

Name	Net weight (kg)
V1316	0,197
V1318	0,309



CASE ADVANCED

A safer, more durable and easier to handle case for Elpress crimping tools, PVX1300 and PVX1300C2. CASE ADVANCED can handle the most demanding conditions. The case is IP67 rated, withstands dust and heavy impacts. Pull handles and wheels make it easier for the user to transport the tool and the right accessories.

Properties:

- lifetime warranty.
- handles can withstand up to 30 kg.
- compartment for easy storage of dies, matrices and punches.
- withstands temperatures from -30 °C up to +90 °C.
- the case can be locked with double padlocks.
- pressure equalisation valve.
- IP67 (fully waterproof to a depth of 1 metre).
- STANAG4280, DEF-STAN 81-41 Certification.



Name	Net weight (kg)
PVX1300-CASE-ADV	7,6





Storage box LV1300B

Storage box that holds the V1300 tool and accessories to crimp Elpress Cu-terminals.

Properties:

- material plywood
- interior material polyethylene
- solid, moulded interior



Name	Net weight (kg)	Length mm	Width	Height
LV1300B	5,12	570	467	130



Storage box L1300 CU-ALU

Additional storage box for accessories for PVX1300. The box holds all the accessories needed when working with the 1300 system from Elpress. The box holds space for 14 B-dies, 1-2 die holders, 12-14 integrated B-dies (DUAL-die pairs), 4 punches (AL crimping), 8 pre-rounding punches and 3 matrixes as well as a matrix holder (example). The box is designed together with the L-PVX1300, and is advantageously used with this box.

Properties:

- material plywood
- interior material polyethylene
- solid, moulded interior



Name	Net weight (kg)	Length mm	Width	Height
L1300 CU-ALU	3,76	570	435	175



Storage box L-PVX1300

Additional storage box for PVX1300. The box is designed to hold PVX1300 with charger and an extra battery. there's also extra space for a few dies, stripping tool and terminals. The box is designed together with the L1300 CU-ALU and is advantageously used together.

Properties:

- material plywood
- interior material polyethylene
- solid, moulded interior



Name	Net weight (kg)	Length mm	Width	Height
L-PVX1300	3,76	570	435	175



Accessories for crimping Al with V1300, V1311-A and PVX1300

Punch and Matrix for indent crimping

For Al-terminals, indent crimping. For the indent crimping of Al-terminals, two crimps are always required.
For 16-150 (185 solid) mm² use matrix holder V1320.

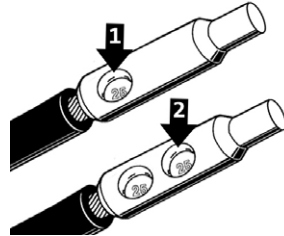

Matrix holder V1320, matrix P13M, punch P13D.

Crimp sequence

Stranded Al mm ²	Solid Al mm ²	Matrix	Punch	Number of crimps	Matrix holder required	Punch holder required	Note
16-25	16-35	P13M	P13D	2	Yes	No	
35-70	50-95	P20M	P20D	2	Yes	No	
95-150	120-185	P25M	P25D	2	Yes	No	
185-240	240	13P32M	P32D	2	No	No	
300-400		13P37M	13P37D	2	No	No	

Matrix with safety line. For Al-terminals, type AKKxxxB/AKSxxxB and sleeves type ASxxxB.

Punch and Matrix for pre-rounding

For Al conductors, pre-rounding.
Use matrix holder V1320.



Matrix holder V1320, matrix R6MR, punch 13R6DR.

Stranded Al mm ²	Solid Al mm ²	Matrix	Punch	Number of crimps	Matrix holder required	Punch holder required
16	16 (+25)	R6MR	13R6DR	1	Yes	No
25	35	R7MR	13R7DR	1	Yes	No
35	50	R8MR	13R8DR	1	Yes	No
50	70	R9MR	13R9DR	1	Yes	No
70	95	R12MR	13R12DR	1	Yes	No
95	120	R13MR	13R13DR	1	Yes	No
120	150	R15MR	13R15DR	1	Yes	No
150	185	R16MR	13R16DR	1	Yes	No
185	240	13R18MR	13R18DR	1	Yes	No
240		13R20MR	13R20DR	1	Yes	No

Matrix holder for the 1300 system

Matrix holder for non-integrated matrix. Punch holder not required for the 1300 system.



Stranded Al mm ²	Solid Al mm ²	Name	Net weight (kg)
16-150	16-185	V1320	0,367

MultiCrimp punch and matrix for indent crimping

For Al-connectors 50-240 mm², indent crimp, both round- and sector shaped conductors. Without need for pre-rounding of sector shaped conductors. Used without matrix holder.



96



Stranded Al mm ²	Matrix	Punch	Number of crimps	Net weight (kg)
50-95	13P5095M	13P5095D	1	0,394
120-150	13P120150M	13P120150D	1	0,394
185-240	13P185240M	13P185240D	2	0,394





Storage box L-Alu

Additional storage box for LV1300B and LV250, with space for accessories to crimp Elpress Al-terminals.

Properties:

- material plywood
- interior material polyethylene
- solid, moulded interior

Name	Net weight (kg)	Length mm	Width	Height
L-ALU	5,17	570	467	130



Storage box L-PVX1300

Additional storage box for PVX1300. The box is designed to hold PVX1300 with charger and an extra battery. there's also extra space for a few dies, stripping tool and terminals. The box is designed together with the L1300 CU-ALU and is advantageously used together.

Properties:

- material plywood
- interior material polyethylene
- solid, moulded interior

Name	Net weight (kg)	Length mm	Width	Height
L-PVX1300	3,76	570	435	175



Storage box L1300 CU-ALU

Additional storage box for accessories for PVX1300. The box holds all the accessories needed when working with the 1300 system from Elpress. The box holds space for 14 B-dies, 1-2 die holders, 12-14 integrated B-dies (DUAL-die pairs), 4 punches (AL crimping), 8 pre-rounding punches and 3 matrices as well as a matrix holder (example). The box is designed together with the L-PVX1300, and is advantageously used with this box.

Properties:

- material plywood
- interior material polyethylene
- solid, moulded interior

Name	Net weight (kg)	Length mm	Width	Height
L1300 CU-ALU	3,76	570	435	175



Accessories for crimping overhead lines with V1300, V1311-A and PVX1300

Crimp dies for AlMgSi (Super B) and Al59

Supplied in pairs. Hexagonal crimping. Use inner die holder V1316, and outer die holder V1318.



Outer die holder V1318, BNP dies, inner die holder V1316.

mm ² Overhead line	Name	Number of crimps	Net weight (kg)	Die holder required	Note
31-62	B16NP	2x5	0,118	Yes	AlMgSi 31-62 mm ² , FeAL: 62 mm ² , ALUS 50 mm ²
99	B20NP	2x5	0,126	Yes	AlMgSi 99 mm ² , FeAL: 99 mm ²
157	13B26	2x16	0,420	No	Overhead line: 157 mm ² (2x16 crimps)
241	13B32	2x16	0,408	No	Overhead line: 241 mm ² (2x16 crimps)

Crimp dies for overhead lines FeAl

Supplied in pairs. BxxFE dies are used for steel sleeves and BxxNP dies are used for Al-sleeves. Use inner die holder V1316 and outer die holder V1318.

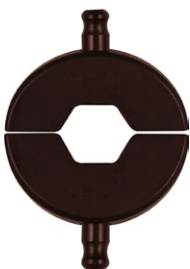

Die pair B16NP

mm ²	Die Fe	Die Al	Number of crimps
62	B6FE	B16NP	2x5
99	B8FE	B20NP	2x5

96

Tools for Cu terminals 10 - 400 mm² and C sleeves 240 mm² (total)



V1300C2



Tested and certified crimp head for crimping Cu-terminals, type KR/KRT 10 mm², KS/KST 10 mm², KRF/KRD/KRT 16-400 mm², KSF/KSD/KST 16-400 mm². Used in combination with foot pump P4000 or battery and mains powered pump PS710 (battery powered version of PS710E is also available).

Properties:

- working pressure 63 MPa (630 bar)
- crimp force 130 kN
- versatile and easy to use

mm ² (Cu)	Name	Crimp geometries	Net weight (kg)	Length mm	Width	Height
10-400	V1300C2	Hexagonal, Oval	4,6	296	125	75

Crimp geometries



V1311C2-A



Tested and certified hydraulic hand-held tool for crimping Cu-terminals, type KR/KRT 10 mm², KS/KST 10 mm², KRF/KRD/KRT 16-400 mm², KSF/KSD/KST 16-400 mm².

Properties:

- fast forward feeding
- the fork can rotate 180°
- crimp force 130 kN
- requires low handle force, about 245N at maximum force
- easy to carry and work with

mm ² (Cu)	Name	Crimp geometries	Net weight (kg)	Length mm	Width	Height
10-400	V1311C2-A	Hexagonal, Oval	5,7	625	150	76



Storage box supplied with the V1311C2-A and V1311-A tools.



ELPRESS

PVX1300C2/PVX1300C2DB

Tested and certified battery-powered crimp gun for crimping Cu-terminals, type KR/KRF and KS/KSF 10-400 mm², C-sleeves up to 240 mm² total area (C95-120).



Properties:

- ergonomic design ensures optimum balance in the user's hand
- crimp monitoring with warning light and signal when the correct pressure/full crimp is not achieved
- LED work lighting
- possibility of documentation of each crimp for unique service control
- crimp force 124 kN (13 tonnes)
- usage temperature -20°C to +40°C
- Li-Ion Makita, 5.0 Ah, 18V
- charger Li-Ion Makita, charging time 22 min 110-240VAC 50-60Hz
- DUAL: 10 - 300 mm²



Crimp geometries

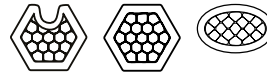

mm ² (Cu)	Name	Crimp geometry	Net weight (kg)	Length	Width	Height	Note
10-400	PVX1300C2	Dual, Hexagonal, Oval	7,5	399	319	75	Delivered in standard case
10-400	PVX1300C2DB	Dual, Hexagonal, Oval	8,1	399	319	75	Delivered with 2 batteries
10-400	PVX1300C2-ADV	Dual, Hexagonal, Oval	15,1	399	319	75	Delivered in CASE ADVANCED
10-400	PVX1300C2DB-ADV	Dual, Hexagonal, Oval	15,1	399	319	75	2 batteries and CASE ADV.
10-400	PVX1300C2-US	Dual, Hexagonal, Oval	5,6	399	319	75	With US charger
10-400	PVX1300C2DB-US	Dual, Hexagonal, Oval	6,2	399	319	75	Delivered with battery and US-charger
10-400	PVX1300C2-WOBC	Dual, Hexagonal, Oval	5,6	399	319	75	without Battery/Charger

Table stand for Cu- and Al-terminals



TS1300, TS1300CU, TS1300AL

The TS1300 is a table stand that can be used with crimp heads DV1300C2 or V1300C2-AL.

The table stand is designed for operators with high frequency use of the C2 crimp head. With the table stand you get a stable, safe and easy use of the C2 crimp head.



mm ²	Name	Crimp geometries	Net weight (kg)	Length mm	Width	Height
10-400	TS1300CU	Dual, Hexagonal, Oval	18,7	190	100	312
16-400	TS1300AL	Punch	20,9	190	100	330
10-400	TS1300		14,1	190	100	215

TS1300 with crimp head

Accessories for crimping Cu with V1300C2, V1311C2-A and PVX1300C2

The B dies below are intended for Cu-terminals, type KR/KRF/KRD/KRT and KS/KSF/KSD/KST, together with both stranded and multi-stranded Cu conductors of Class 2 according to IEC 60228. For multi-stranded (Class 5) Cu conductors, crimping is recommended with the Dual system.

Crimp dies (C-fork) for KRF/KSF

Supplied in pairs.

For Cu-terminals, hexagonal crimping. Used with die holder V1330.



B dies.

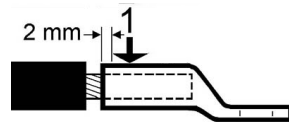

Crimp sequence for one crimp.

mm ² KR/KS, KRF/KSF	Name	Number of crimps	Net weight (kg)
10	B8	1	0,101
16	B9	1	0,103
25	B11	1	0,109
35	B13	1	0,113
50	B14,5	1	0,111
70	B17	1	0,107
95	B20	1	0,115
120	B22	1	0,148
150	B25	1	0,135



Crimp dies (C fork) for KRF/KSF (integrated)

Supplied in pairs.
For Cu-terminals, hexagonal crimping. Used without a die holder.



13CB20

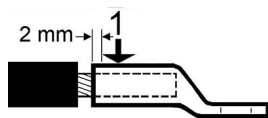

Crimp sequence for one crimp.

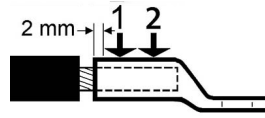

Crimp sequence for two crimps.

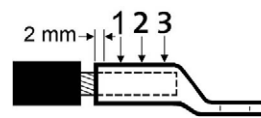

Crimp sequence for three crimps.

mm ² KR/KS, KRF/KSF	Name	Number of crimps	Net weight (kg)	Die holder required	Note
10	13CB8	1	0,434	No	
16	13CB9	1	0,446	No	
25	13CB11	1	0,468	No	
35	13CB13	1	0,488	No	
50	13CB14,5	1	0,481	No	
70	13CB17	1	0,480	No	
95	13CB20	1	0,497	No	
120	13CB22	1	0,537	No	
150	13CB25	2	0,474	No	
185	13CB27	2	0,478	No	
240	13CB30	2	0,535	No	
300	13CB32	2	0,491	No	
400	13C21B38	3	0,450	No	Used in V1300C2 but NOTE that V13C21 must be in the crimp head/fork.

96

Crimp dies (C-fork) for KRD/KSD

For Cu-terminals, hexagonal crimping. Supplied in pairs.
The B dies below are intended for Cu-terminals, type KRD and KSD, together with Cu conductors class 2 according to IEC 60228.
Used with die holder V1330.



B dies.



Die holder V1330 (pair).

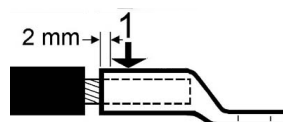

Crimp sequence for one crimp.

mm ² KRD/KSD	Name	Number of crimps	Net weight (kg)
16	B8	1	0,101
25	B9	1	0,103
35	B11	1	0,109
50	B12	1	0,108
70	B14	1	0,112
95	B16	1	0,107
120	B19	1	0,118
150	B22	1	0,148



Crimp dies (C fork) for KRD/KSD (integrated)

Supplied in pairs.
For Cu-terminals, hexagonal crimping. Used without a die holder.

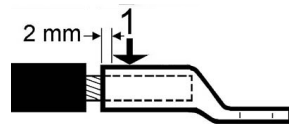

Crimp sequence for one crimp.

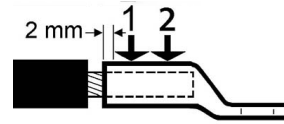

Crimp sequence for two crimps.

mm ² KRD/KSD	Name	Number of crimps	Net weight (kg)
16	13CB8	1	0,434
25	13CB9	1	0,446
35	13CB11	1	0,468
50	13CB12	1	0,466
70	13CB14	1	0,483
70	13CB16	1	0,484
120	13CB19	1	0,500
150	13CB22	1	0,537
185	13CB25	2	0,474
240	13CB27	2	0,478
300	13CB30	2	0,535
400	13CB32	2	0,491

Crimp dies (C-fork) for KRT/KST

For Cu-terminals, hexagonal crimping. Supplied in pairs.
The B dies below are intended for Cu-terminals, type KRD and KSD,
together with Cu conductors class 2 according to IEC 60228.
Used with die holder V1330.



B dies.



Die holder V1330 (pair).

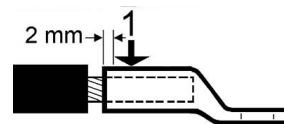

Crimp sequence for one crimp.

mm ² KRT/KST	Name	Number of crimps	Net weight (kg)	Die holder required
10	B7	1	0,101	Yes
16	B8,5	1	0,101	Yes
25	B10	1	0,106	Yes
35	B12	1	0,108	Yes
50	B14	1	0,112	Yes
70	B16	1	0,107	Yes
95	B18	1	0,120	Yes
120	B19	1	0,118	Yes
150	B22	1	0,148	Yes
185	B24	1	0,139	Yes



Crimp dies (C fork) for KRT/KST (integrated)

Supplied in pairs.
For Cu-terminals, hexagonal crimping. Used without a die holder.

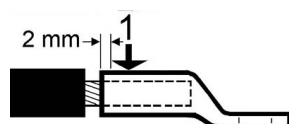

Crimp sequence for one crimp.

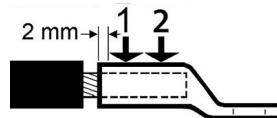

Crimp sequence for two crimps.

mm ² KRT/KST	Name	Number of crimps	Net weight (kg)
10	13CB7	1	0,46
16	13CB8,5	1	0,46
25	13CB10	1	0,475
35	13CB12	1	0,466
50	13CB14	1	0,483
95	13CB16	1	0,484
95	13CB18	1	0,502
120	13CB19	1	0,50
150	13CB22	1	0,537
185	13CB24	2	0,482
240	13CB26	2	0,48
300	13CB30	2	0,535
400	13CB32	2	0,491

96

Crimp dies (C-fork) for C-sleeves

For Cu branching with C-sleeves, oval crimping.
Unless otherwise stated, use die holder V1330.



BC dies.

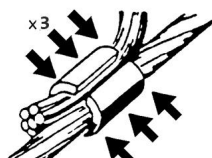
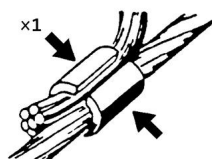

1 and 3 crimps.

Through conductor mm ²	Branching mm ²	mm ²	Name	Number of crimps	Net weight (kg)	Die holder required
6-16	6-16	Total: 12-26	BC5	1	0,112	Yes
5-25	5-25	Total: 30-50	BC6	1	0,149	Yes
6-50	6-50	Total: 50-100	BC8-9	1	0,138	Yes
25-120	25-120	Total: 95-190	13CBC13	3	0,620	No
25-185	25-185	Total: 175-240	13CBC15	3	0,462	No



Die holders for the 1300 system (C2)

Supplied in pairs.



Die holder V1330 (pair).

Name	Net weight (kg)
V1330	0,43



Tools for Cu terminals 10 - 800 mm², Al terminals 16 - 630 mm² and C-sleeves 6 - 300 mm²



V250



Tested and certified crimp head for crimping Cu-terminals, type KR/KRT 10 mm², KS/KST 10 mm², KRF/KRD/KRT 16-800 mm², KSF/KSD/KST 16-800 mm², Al-terminals 16-630 mm² (-300 solid), C sleeves 6/6-300/300 mm². Used in combination with foot pump P4000 or the electrically powered pump PS710 (battery powered version of PS710E is also available).

Properties:

- working pressure 63 MPa (630 bar)
- crimp force 250kN (25 tonnes)
- large crimp area, 10-800 mm²

mm ² (Cu)	mm ² (Stranded Al)	mm ² (Solid Al)	Name	Crimp geometries	Net weight (kg)	Length mm	Width	Height
10-800	16-630	16-300	V250	Punch, Hexagonal, Oval	4,68	280	111	74

Crimp geometries

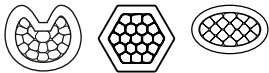

Accessories for crimping Cu with V250

The B dies are intended for Cu-terminals, type KR/KRF and KS/KSF, together with stranded Cu conductors of Class 2 according to IEC 60228. For multi-stranded (Class 5) Cu conductors, crimping with the Dual system is recommended.

Crimp dies for KRF/KSF

Supplied in pairs.

For Cu-terminals, KRF/KSF, hexagonal crimping. If die holders are required, use inner die holder **V2506** and outer die holder **V2508**

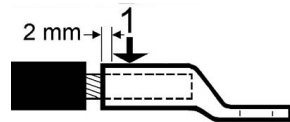

Crimp sequence for one crimp.

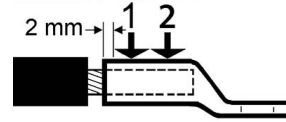

Crimp sequence for two crimps.

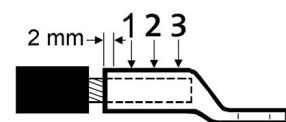

Crimp sequence for three crimps.

Die pair B2542, used without die holder.

mm ² KRF/KSF	Name	Number of crimps	Net weight (kg)	Die holder required
10	B8	1	0,101	Yes
16	B9	1	0,103	Yes
25	B11	1	0,109	Yes
35	B13	1	0,113	Yes
50	B14,5	1	0,111	Yes
70	B17	1	0,107	Yes
95	B20	1	0,115	Yes
120	B22	1	0,148	Yes
150	B25	1	0,135	Yes
185	B27	1	0,128	Yes
240	B30	1	0,115	Yes
300	B2532	1	1,018	No
400	B2538	2	0,896	No
500	B2542	2	0,874	No
630	B2553	3	0,912	No



Crimp dies for KRD/KSD

Supplied in pairs.

For Cu-terminals, KRD/KSD, hexagonal crimping. If die holders are required, use inner die holder V2506 and outer die holder V2508.

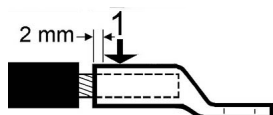

Crimp sequence for one crimp.

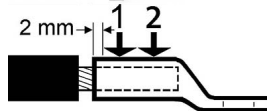

Crimp sequence for two crimps.

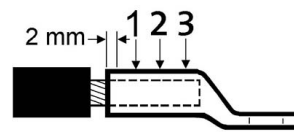

Crimp sequence for three crimps.

Die pair B2542, used without die holder.

mm ² KRD/KSD	Name	Number of crimps	Net weight (kg)	Die holder required
16	B8	1	0,101	Yes
25	B9	1	0,103	Yes
35	B11	1	0,109	Yes
50	B12	1	0,108	Yes
70	B14	1	0,112	Yes
95	B16	1	0,107	Yes
120	B19	1	0,118	Yes
150	B22	1	0,148	Yes
185	B25	1	0,135	Yes
240	B27	1	0,128	Yes
300	B30	1	0,115	Yes
400	B2532	1	1,018	No
500	B2540	2	0,891	No
630	B2545	3	0,899	No
800	B2553	3	0,912	No

96

Crimp dies for KRT/KST

Supplied in pairs.

For Cu-terminals, KRT/KST, hexagonal crimping. If die holders are required, use inner die holder V2506 and outer die holder V2508.

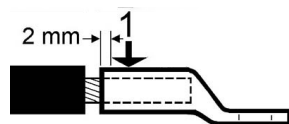

Crimp sequence for one crimp.

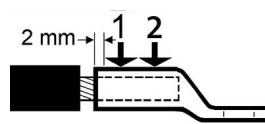

Crimp sequence for two crimps.

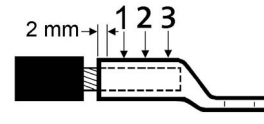

Crimp sequence for three crimps.

Die pair B2542, used without die holder.

mm ² KRT/KST	Name	Number of crimps	Net weight (kg)	Die holder required
10	B7	1	0,101	Yes
16	B8,5	1	0,101	Yes
25	B10	1	0,106	Yes
35	B12	1	0,108	Yes
50	B14	1	0,112	Yes
70	B16	1	0,107	Yes
95	B18	1	0,120	Yes
120	B19	1	0,118	Yes
150	B22	1	0,148	Yes
185	B24	1	0,139	Yes
240	B26	1	0,131	Yes
300	B30	1	0,115	Yes
400	B2532	1	1,018	No
500	B2540	2	0,891	No
630	B2545	3	0,899	No
800	B2553	3	0,912	No



Crimp dies for C-sleeves

Die pair for Cu-branching with C-sleeves, oval crimping. If a die holder is required, use inner die holder **V2506** and outer die holder **V2508**, for the V250 system.



Die holder V2508, BC dies, die holder V2506.



Die pair B25C16

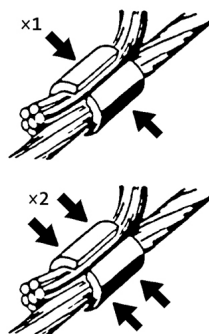

One and two crimps.

Through conductor mm ²	Branching mm ²	mm ²	Name	Number of crimps	Net weight (kg)	Die holder required
6-16	6-16	Total: 12-26	BC5	1	0,112	Yes
5-25	5-25	Total: 30-50	BC6	1	0,149	Yes
6-50	6-50	Total: 50-100	BC8-9	1	0,138	Yes
25-120	25-120	Total: 95-190	BC13	1	0,142	Yes
25-185	25-185	Total: 175-240	B25C15	1	1,012	No
25-300	25-300	Total: 245-425	B25C18	2	0,954	No
150-300	150-300	Total: 450-540	B25C21	2	0,864	No

96

Die holders for the 250 system

Inner and outer die holder for the 250 system.



Inner die holder V2506.



Outer die holder V2508.

Name	Net weight (kg)
V2506	0,341
V2508	0,632



Accessories for crimping Al with V250

Punch and Matrix for indent crimping

For indent crimping of Al-terminals and connectors. Two crimps are always needed, see image.
For solid (Class 1) and solid (Class 2) Al-conductors according to IEC 60228. (no punch holder is needed)

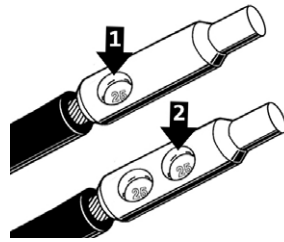

Matrix holder V2521, matrix P13M, punch P13D.

Crimp sequence

Stranded Al mm ²	Solid Al mm ²	Matrix	Matrix holder	Punch	Number of crimps	Used for
16-25	16-35	P13M	V2521	P13D	2	
35-70	50-95	P20M	V2521	P20D	2	
95-150	120-185	P25M	V2521	P25D	2	
185-240	240	P32M	V2531	P32D	2	
300	300	P36M	V2531	P36-40-44D	2	
300-400		P2537M		P2537D	2	Terminals and through connectors of type AK/AS/AKK/AKS 300B-400B
400		P40M	V2531	P36-40-44D	2	
500		P44M	V2531	P36-40-44D	2	Terminals and through connectors of type AK/AS/AKK/AKS 500B
500-630		P2552M		P2552D	2	Terminals and through connectors type AK/AS/AKK/AKS 500A



Punch and Matrix for pre-rounding

For Al conductors, pre-rounding. Use punch holder V2540.



Matrix holder V2531, matrix R18MR, punch R18DR, punch holder V2540.

Stranded Al mm ²	Solid Al mm ²	Matrix	Matrix holder	Punch
16	16 (+25)	R6MR	V2521	R6DR
25	35	R7MR	V2521	R7DR
35	50	R8MR	V2521	R8DR
50	70	R9MR	V2521	R9DR
70	95	R12MR	V2521	R12DR
95	120	R13MR	V2521	R13DR
120	150	R15MR	V2521	R15DR
150	185	R16MR	V2521	R16DR
185	240	R18MR	V2531	R18DR
240		R20MR	V2531	R20DR
300	300	R21MR	V2531	R21DR
400		R26MR	V2531	R26DR
500		R28MR	V2531	R28DR

96

Matrix- and punch holder for the 250 system

Matrix- and punch holder for the 250 system.



Stranded Al mm ²	Solid Al mm ²	Name	Net weight (kg)
16-150	16-185	V2521	0,921
185-500	240-300	V2531	0,750
16-500	16-300	V2540	0,157

Accessories for crimping overhead lines with V250

Crimp dies for AlMgSi(Super B) and Al59

Supplied in pairs. For joints on overhead lines AlMgSi (Super B) and Al59, hexagonal crimping. Use inner die holder **V2506** and outer die holder **V2508**.



Die holder V2508, BNP dies, die holder V2506.

mm ² Overhead line	Name	Number of crimps	Net weight (kg)
31-62	B16NP	2x5	0,118
99	B20NP	2x5	0,126
157	B26NP	2x8	0,140

Crimp dies for overhead lines FeAl

Supplied in pairs. BxxFE dies are used for steel sleeves and BxxNP dies are used for Al-sleeves. Use inner die holder **V2506** and outer die holder **V2508**.

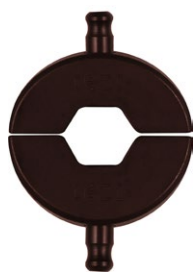

Die pair B16NP

mm ²	Die Fe	Die Al	Number of crimps
62	B6FE	B16NP	2x5
99	B8FE	B20NP	2x5





Storage box L-Alu

Additional storage box for LV1300B and LV250, with space for accessories to crimp Elpress Al-terminals.

Properties:

- material plywood
- interior material polyethylene
- solid, moulded interior



Name	Net weight (kg)	Length mm	Width	Height
L-ALU	5,19	570	467	130



Storage box LV250

Storage box with space for tool V250 and all necessary accessories to crimp Elpress Cu-terminals.

Properties:

- material plywood
- interior material polyethylene
- solid, moulded interior



Name	Net weight (kg)	Length mm	Width	Height
LV250	5,09	570	467	130



Crimp station for industrial crimping of KRF/KSF terminals 10 - 300 mm²



CS2500

Elpress crimp station CS2500 offers efficient production with the greatest possible personal safety. Advanced, intelligent properties combined with simplicity make the product unique.



Crimp station CS2500.

Properties:

- designed for continuous production of electric Cu-terminals, 10-300 mm²
- quick locking of the terminal using low force shortens the overall time for crimping
- automatic setting of crimp force up to 250 kN, provides optimal service life for tools and accessories
- only one crimp necessary throughout the work area
- integrated Elpress DUAL System
- hydraulic pump PS710D with control, monitoring and error reporting
- operated with a foot pedal
- CE approved, meets the requirements of the Safety of machinery directive
- software Analyzer for analysis and report printout of crimps
- 110-240VAC 50-60Hz

mm ² (Cu)	Name	Net weight (kg)	Length mm	Width	Height
10-300	CS2500	59,5	200	350	340



Pump PS710D.



Crimp dies for CS2500

Supplied in pairs.
For Cu-terminals, type KR/KRF and KS/KSF and flexible Cu conductors,
no die holders are required.



Die pair 13DCB20.

mm ²	Name	Number of crimps	Net weight (kg)
10	13DCB8	1	0,456
16	13DCB9	1	0,440
25	13DCB11	1	0,465
35	13DCB13	1	0,486
50	13DCB14,5	1	0,497
70	13DCB17	1	0,503
95	13DCB20	1	0,507
120	20DCB22	1	0,599
150	20DCB25	1	0,599
185	20DCB27	1	0,591
240	20DCB30	1	0,587
300	20DCB32	1	0,564

06

Analyzer - software for analysis of crimps and system calibration



The Analyzer program is used to ensure quality crimps and save data to quality documents. By simple means, all crimps can be studied in a PC environment where they get their own ID number for full traceability. The unique SPC tool, Statistic Process Control, makes it possible to consider crimping as a measurable process. Analyzer is a statistical program for systematic studies of variations in the crimp process. Furthermore, you can export, import, print or save graphs, calibration data, batch reports etc.

Properties:

- Elpress Analyzer improves overall quality
- helps the user
- provides a process improvement tool
- measures and shows all crimps
- supports preventive maintenance of equipment
- creates traceability and documentation
- makes communication easy
- increases user skills
- eliminates incorrect crimps
- comes with instructions for use

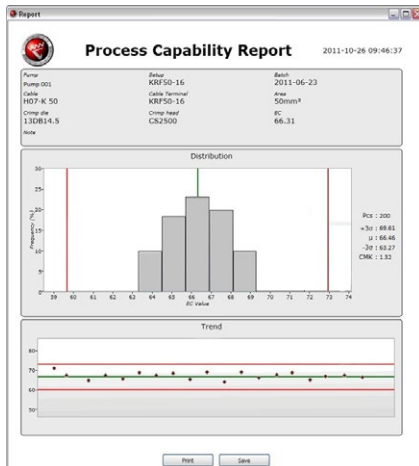

Analyzer, measures and analyses each individual crimp.



Tools for Cu-terminals 500 - 1000 mm² and Al-terminals 800 - 1200 mm²



V1470



Tested and certified crimp head for contact crimping Cu-terminals, type KRF/KSF 500-800 mm², KRD/KSD, KRT/KST 500-1000 mm², Al-terminals 800-1200 mm², C-sleeves 245-540 mm² (C150-185 och C240-300). Used in combination with foot pump P4000 or electrically powered pump PS710.

Properties:

- working pressure 63 MPa (630 bar)
- crimp force 400 kN
- supplied in plywood box

mm ² (Cu)	mm ² (Stranded Al)	Name	Crimp geometries	Net weight (kg)	Length mm	Width	Height
500-1000	800-1200	V1470	Punch, Hexagonal, Oval	20,76	510	235	103

Crimp geometries

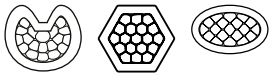

Crimp dies for KRF/KSF, KR D/KSD and KRT/KST

Supplied in pairs.

For Cu-terminals, hexagonal crimping. When crimping Cu-terminals, two crimps are always required.

Flexible conductors in KRF/KSF and stranded conductors in KR D/KSD/KRT/KST.

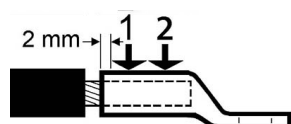

B4040.

Crimp sequence for two crimps.

mm ²	Name	Number of crimps	Net weight (kg)	Die holder required	Note
500	B4040	2	4,011	No	For stranded Cu-conductors: KR D/KSD, KRT/KST 500 mm ²
500	B4042	2	4,067	No	For multi strand Cu-conductors: KRF/KSF 500 mm ²
630	B4045	2	3,959	No	For stranded Cu-conductors: KR D/KSD, KRT/KST 630 mm ²
630-800	B4053	2	3,901	No	For multi strand Cu-conductors: KRF/KSF (and stranded Cu conductors 800 mm ² : KR D/KSD/KRT/KST)
1000	B4056	2	3,670	No	For stranded Cu-conductors: KR D/KSD, KRT/KST

Crimp dies for C-sleeves

Supplied in pairs.

For Cu branching with C-sleeve, oval crimping.

Only one crimp is required for Cu branches with C-sleeve.



B40C18.

Through conductor mm ²	Branching mm ²	mm ²	Name	Number of crimps	Net weight (kg)	Die holder required
25-300	25-300	Total: 245-425	B40C18	1	4,000	No
150-300	150-300	Total: 450-540	B40C21	1	4,083	No



Punch and Matrix

For Al-terminals, indent crimping.
Use matrix holder **V1471**.

When crimping Al-terminals, two crimps are always required.



Matrix holder V1471, Matrix W60M, punch W60D.

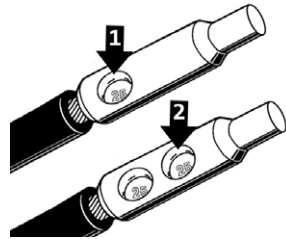

Crimp sequence

Stranded Al mm ²	Matrix	Punch	Number of crimps	Matrix holder required	Punch holder required
800-1000	W60M	W60D	2	Yes	No
1200	W70M	W70D	2	Yes	No

Lightweight and versatile designed pumps based on customer needs



PS710

The PS710 is an electrically driven pump for crimping with advanced control and monitoring of crimping progress. A flexible system for a wide range of applications with high performance and reliability for professional use. The pump is suitable for cabling manufacturers as well as for fitters working in the field. The PS710 can be used for all types of crimping or cutting. The PS710 has a power source for all types of crimping.

Technical data:

- possibility to use different pressure ranges, 0 - 700 Bar
- can be used with a PC on a computer network with a printer, does not apply to the PS710R
- oil flow at 20 bar: 0.6 litre/min (PS710D 1.2 litre/min)
- oil volume: 1.0 litre
- oil type: HYDREX MV 22 or similar
- crimps/battery charge: 120 crimps with Cu 150 mm²
- ambient temperature: -22 to 55°C
- protection: IP54
- mains operation 85-276VAC 50-60Hz
- Li-ion battery 28,8V, 3,0 Ah
- meet CE requirements: Safety of machinery 2006/42/EC, Electromagnetic compatibility 2014/30/EU, Low Voltage Directive 2014/35/EU, ROHS 2014/35/EU, WEEE 2012/19/EU
- weight approx. 12,4 kg
- compact dimensions 370 x 170 x 280 mm

The pump consists of three basic versions, each with customisation options.



PS710D

- For cabling manufacturers. used with crimping station CS2500

Properties:

- unique electronic control system together with special PC software
- analysis and process monitoring/control, SPC, for tracking each crimp
- LCD Display with keypad for full status information of pump to the fitter
- communication with PC in real time provides instant quality control
- integrated communication via CAN with Elpress CS2500
- high flow hydraulic pump for fastest possible crimping
- can be used with PC on a computer network with printer



Pump PS710D

Name	Net weight (kg)	Length mm	Width	Height
PS710D	12,4	370	170	280





PS710E

For fitters working in the distribution network or industry.

Properties:

- small and light weight, which makes the product easy to use in every situation
- maximum performance, can be used both with Li-ion battery 28.8 V or 220V mains power
- LCD Display with keypad for full status information of pump to the fitter
- able to store and document crimps in the control system
- PC communication via USB
- to be used with crimp heads and cable cutters
- Elpress ergonomic handle ERGOCOM, with wireless communication can be selected for
- charger 230 VAC 50 Hz, 10.8-28.8 V, charging time 65 min



Pump PS710E

Name	Net weight (kg)	Length mm	Width	Height
PS710E	12	370	170	280



PS710E251 and PS710E501*

Contains:

- pump E-version
- cable
- hydraulic hose 2.4 m or 5.0 m with wireless communication ERGOCOM
- battery
- charger
- carrying strap
- 110-240VAC 50-60Hz



Name	Gross weight (kg)	Length mm	Width	Height	Note
PS710E251	24,5	370	170	280	PS710E pump with carrying strap. Ergocom hose 2.4 m and power cord EU, battery and charger
PS710E501	26,0	370	170	280	PS710E pump with carrying strap. Ergocom hose 5.0 m and power cord EU, battery and charger
PS710E501-US	26,0	370	170	280	PS710E pump with carrying strap. Ergo hose 5.0 m and power cord US, battery and charger
PS710E251-US	24,5	370	170	280	PS710E pump with carrying strap. Ergo hose 2.4 m and power cord US, battery and charger

ERGOCOM hoses are not available in US/North American market.



PS710R

For users looking for a reliable standard product (without the need for documented traceability).



Pump PS710R

Properties:

- pump control without electronic control system, relay controlled
- easily equipped without data communication
- without battery
- to be used with crimp heads and cable cutters
- Elpress ergonomic handle ERGO, with wired communication can be selected for
- 110-240VAC 50-60Hz

Name	Net weight (kg)	Length mm	Width	Height
PS710R	12	370	170	280



PS710R250 and PS710R500*

Contains:

- pump R version
- cable
- hydraulic hose 2.4 or 5.0 m with wired communication ERGO
- carrying strap



Name	Gross weight (kg)	Length mm	Width	Height	Note
PS710R250	23,0	370	170	280	PS710R pump with carrying strap. Ergo hose 2.4 m and power cord EU
PS710R500	24,5	370	170	280	PS710R pump with carrying strap. Ergo hose 5.0 m and power cord EU
PS710R250-US	23,0	370	170	280	PS710R pump with carrying strap. Ergo hose 2.4 m and power cord US
PS710R500-US	24,5	370	170	280	PS710R pump with carrying strap. Ergo hose 5.0 m and power cord US



Accessories for PS710x

Operating handle for operation of pump PS710. Ergonomically designed handle that reduces the load on the operator at the workstation. ERGOCOM is controlled via Bluetooth and ERGO is wired. Available in different designs depending on the length of the hydraulic hose.



Name	Pcs/ pack	Note
HYD.SLANG KPL. 2,4M ERG PS710E	1	Hydraulic hose (2.4 m) for PS710E, with ERGO handle
HYD.SLANG KPL. 5M ERGO PS710E	1	Hydraulic hose (5 m) for PS710E, with ERGO handle
HYD.SLANG KPL.2,4M ERGO PS710R	1	Hydraulic hose (2.4 m) for PS710R, with ERGO handle
HYD.SLANG KPL. 5M ERGO PS710R	1	Hydraulic hose (5 m) for PS710R, with ERGO handle
HYD.SLANG KPL. 2,4M ERGOCOM	1	Hydraulic hose (2.4 m) for PS710R, with ERGOCOM handle (bluetooth)
HYD.SLANG KPL. 5M ERGOCOM	1	Hydraulic hose (5 m) for PS710R, with ERGOCOM handle (bluetooth)
FCU-PS710R	1	Foot pedal for PS710R
FCU-PS710D&E	1	Foot pedal for PS710D and PS710E
BÄRREM PS710	1	Carrying strap for all PS710 versions

ERGOCOM hoses are not available in US/North American market

Hydraulic foot pump



P4000



Properties:

- unique version in high strength aluminium alloy
- ergonomic design
- smooth, anodised (electro-oxidised) surfaces – easy to keep clean
- highly efficient, two-stage pump system with fast feed
- single foot-operated pressure relief (tool return) after automatic stop when crimping is complete
- 2.2 m hose with quick coupling
- standard pressure setting 630 bar/63 MPa, (max. setting 700 bar)
- safety valve for return at all pressures
- smooth transport mode for the hose
- special output for pressure monitoring

Name	Net weight (kg)	Length mm	Width	Height
P4000	8,8	500	180	280



Overhead line connectors

Overhead line connectors	2
Twist connector for Cu lines 10 - 35 mm ²	2
Twist connector for Al lines 31 - 99 mm ²	2
Overhead line connectors 31 - 241 mm ² for AlMgSi (Super B) and Al59	3
Overhead line connectors 62 and 99 mm ² for FeAl-line	3
Crimp tool for Cu-terminals 10 - 240 mm ² , Al-terminals 16 - 25 mm ² (-35 solid) mm ² and C-sleeves 100 mm ² (total)	4
Accessories for crimping overhead lines with T2600, V600, V611 and PVX611	6
Tools for Cu-terminals 10 - 400 mm ² , Al-terminals 16 - 400 mm ² and C-sleeves 6 - 240 mm ² (total area)	7
Accessories for crimping overhead lines with V1300, V1311-A and PVX1300	9
Tools for Cu terminals 10 - 800 mm ² , Al terminals 16 - 630 mm ² and C-sleeves 6 - 300 mm ²	10
Accessories for crimping overhead lines with V250	11

Overhead line connectors



System Elpress

System Elpress consists of terminals and tools that are designed and tested together to give a certified crimping result. This ensures that users will feel confident when using our systems, and that a secure connection will be achieved through the proper handling of our products.

Overhead line connectors

The Elpress program for overhead line connectors includes products for splicing copper lines, alloyed aluminium lines type AlMgSi (Super B) and Al59, as well as for FeAl lines. In addition to the well-known copper and aluminium twist connectors, we also offer LFS and LFEAL contact crimp connectors that are crimped using the Elpress V600, V1300 and V250 systems. The LFS and LFEAL contact crimp connectors and Elpress System have been tested against requirements according to SS 4241241.

Twist connector for Cu lines 10 - 35 mm²



Properties:

- material copper
- for wire and line, see table
- the joint is rotated so that it is screwed in the opposite direction to the turn of the line
- tool: wrench

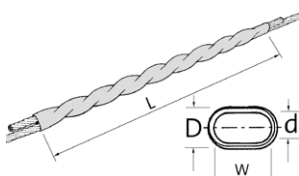

mm ² (Cu)	Name	W mm	d	D	L	Marking	Number of twists	Single strand / Multi strand wire	Pcs/pack
10	K10T	7,8	4	5,6	200	K10T XXXX	5	Multi strand wire	100
16	K16	11,1	5,8	7,4	250	K16 XXXX	3,5	Single strand	100
25	K25	13,8	7,1	8,9	300	K25 XXXX	3,5	Multi strand wire	100
35	K35	16,2	8,3	10,3	350	K35 XXXX	3,5	Single strand	100

Twist connector for Al lines 31 - 99 mm²



Properties:

- material aluminium
- the joint is rotated so that it is screwed in the opposite direction to the turn of the line
- tool: wrench

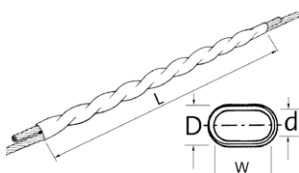

mm ² (Cu)	Name	W mm	d	D	L	Marking	Number of twists	Pcs/pack
31	1006	17,3	9,1	13,1	355	1006 XX	3,5	100
49	1009	21	11,0	15,4	465	1009 XX	4	100
62	1010AL	23	12,0	16,6	480	1010 XX	4	10
99	1014AL	28	14,7	19,7	660	1014 XX	4,5	10



Overhead line connectors 31 - 241 mm² for AlMgSi (Super B) and Al59



Properties:

- material aluminium
- for splicing overhead lines
- meets the requirements of SS 4241241
- the connector tube is supplied with contact paste on the inside
- the conductor must be cleaned

mm ² (Cu)	Name	d mm	D	L	Tool	Number of crimps	Marking	Pcs/pack
31	LFS31	8	15	200	V600, V1300, V250	10	LFS31 16 ALMGSI XXXX AL-59	10
62	LFS62	11	16	200	V600, V1300, V250	10	LFS62 16 ALMGSI XXXX AL-59	10
99	LFS99	13,5	18,7	250	V600, V1300, V250	10	LFS99 20 ALMGSI XXXX AL-59	10
157	LFS157	17,5	24	400	V1300, V250	16	LFS157 26 ALMGSI XXXX AL-59	5
241	LFS241	21	30	450	V1300, V250	16	LFS241 32 ALMGSI XXXX AL-59	5

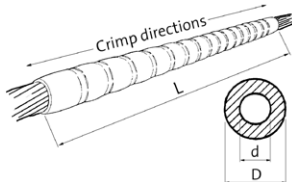

Crimp sequence, see picture.

2x10 crimps are required when crimping LFS99 with T2600, V600, V611 and PVX611.

Overhead line connectors 62 and 99 mm² for FeAl-line



Properties:

- outer Al-sleeve + inner steel sleeve for the centre strands
- meets the requirements of SS 4241241

mm ² (Cu)	Name	d mm	d1	D	D1	L	L1	Tool	Number of crimps	Marking	Pcs/pack
62	LFEAL62	14,3	4	16,0	6	310	95	V1300, V250, V600	10	LFEAL 62 6 XXXX 3	3
99	LFEAL99	13,5	5	18,7	8	360	95	V1300, V250, V600	10	XXXX, LFEAL 99 8 XXXX	3



Elpress logotype is included on the marking. Marking XXXX = Year, week.

Crimp sequence, see picture.

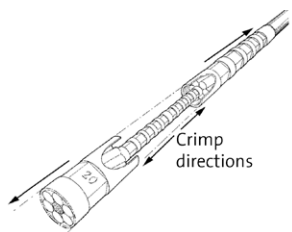

Crimp tool for Cu-terminals 10 - 240 mm², Al-terminals 16 - 25 mm² (-35 solid) mm² and C-sleeves 100 mm² (total)



V600



Tested and certified crimp head for crimping Cu-terminals, type KR/KS 10 mm², KRF/KSF 16-150 mm², KRD/KSD 16-185 mm², KRT/KST 10-240 mm², Al-terminals 16-25 mm² (-35 solid), C-sleeves 6/6-50/50 mm², DIN 46235 10-95 mm².

Used in combination with foot pump P4000 or the electrically powered pump PS710 (battery powered version of PS710E is also available).

Properties:

- working pressure 63 MPa (630 bar)
- crimp force 55 kN
- robust fabric bag with room for 10 dies included

mm ² (Cu)	mm ² (Stranded Al)	mm ² (Solid Al)	Name	Crimp geometries	Net weight (kg)	Length mm	Width	Height
10-240	16-25	16-35	V600	Punch, Hexagonal, Oval	2,45	189	74	53

Crimp geometries

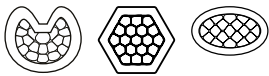

V611



Tested and certified hand-held tool for crimping Cu-terminals, type KR/KS 10 mm², KRF/KSF 16-150 mm², KRD/KSD 16-185 mm², KRT/KST 10-240 mm², Al-terminals 16-25 mm² (-35 solid), C-sleeves 6/6-50/50 mm², DIN 46235 10-95 mm².

Properties:

- fast-feed to crimp engagement provides short crimp times
- crimp force 55 kN
- delivered in sturdy textile bag

mm ² (Cu)	mm ² (Stranded Al)	mm ² (Solid Al)	Name	Crimp geometries	Net weight (kg)	Length	Width	Height
10-240	16-25	16-35	V611	Punch, Hexagonal, Oval	2,6	425	115	53

Crimp geometries



ELPRESS



PVX611/PVX611DB



Tested and certified battery-powered crimp tool for crimping Cu-terminals, type KR/KS 10 mm², KRF/KSF 16-150 mm², KR/D/KSD 16-185 mm², KRT/KST 10-240 mm², Al-terminals 16-25 mm² (-35 solid), C sleeves 6/6-50/50 mm², DIN 46235 10-95 mm². PVX611DB has an extra battery.

Properties:

- protects against dirt and dust through the closed chassis
- ergonomic design ensures optimum balance in the user's hand
- swivel opening crimp fork
- crimp force control using pressure monitoring
- one handed operation for easy work
- LED lighting for easier work
- fast-forward feeding for more efficient crimping
- display with information about the tool and service intervals
- tested together with Elpress TB dies and KB22/KB25
- crimp monitoring via display when the correct pressure/complete crimping is not achieved (warning light LED and signal)

Crimp geometries



mm ² (Cu)	mm ² (Stranded Al)	mm ² (Solid Al)	Name	Crimp geometries	Net weight (kg)	Length mm	Width	Height	Note
10-150	16-25	16-35	PVX611	Punch, Oval, Hexagonal	5,50	414	116	75	Charger: 230VAC
10-150	16-25	16-35	PVX611DB	Punch, Oval, Hexagonal	5,85	414	116	75	Delivered with 2 batteries
10-150	16-25	16-35	PVX611-US	Punch, Oval, Hexagonal	5,50	414	116	75	Charger: 115VAC
10-150	16-25	16-35	PVX611-WOBC	Punch, Oval, Hexagonal	3,90	414	116	75	Without Battery/Charger



T2600



Mechanical hand-held tool for crimping Cu-terminals, type KR/KS 10 mm², KRF/KSF 16-95 mm², KR/D/KSD 16-120 mm², KRT/KST 10-120 mm², Al-terminals 16-25 mm² (-35 solid), and C-sleeves 6/6-50/50 mm², DIN 46235 10-95 mm².

Properties:

- opening for easy die changes and for quick removal after jointing
- crimp force approx. 57 kN
- advanced force ratio for lowest handle force
- easy to work with in confined spaces
- only four die pairs are required to crimp 10-95 mm² Cu
- quick feed function
- delivered in a metal box

Crimp geometries

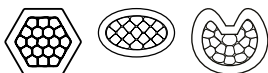

mm ² (Cu)	mm ² (Solid Al)	Name	Crimp geometries	Net weight (kg)	Length mm	Width	Height
10-95	35	T2600	Punch, Hexagonal, Oval	1,9	445	185	52
10-120	35	T2600B	Punch, Hexagonal, Oval	4,12	445	185	52
10-120	35	T2600C	Punch, Hexagonal, Oval	4,12	445	185	52



Accessories for crimping overhead lines with T2600, V600, V611 and PVX611

Crimp dies for overhead line

For joints on overhead lines AlMgSi (Super B) and Al59, hexagonal crimping. Supplied in pairs.



Die pair TBNP 16-20.

mm ² Overhead line	Name	Number of crimps	Net weight (kg)	Note
31 - 99	TBNP16-20	2x5, 2x10	0,135	Used for AlMgSi and FeAl, LFS31, LFS62 and LFS99

Tools for Cu-terminals 10 - 400 mm², Al-terminals 16 - 400 mm² and C-sleeves 6 - 240 mm² (total area)



V1300



Tested and certified crimp head for crimping Cu-terminals, type KR/KRT 10 mm², KS/KST 10 mm², KRF/KRD/KRT 16-400 mm², KSF/KSD/KST 16-400 mm², Al-terminals 16-400 mm² (-240 solid), DIN 46235 10-300 mm², C sleeves up to 240 mm² total area (C95-120). Used in combination with foot pump P4000 or the electrically powered pump PS710 (battery powered version of PS710E is also available).

Properties:

- working pressure 63 MPa (630 bar)
- crimp force 130 kN (13 tonnes)
- versatile and easy-to-use steel crimp head

mm ² (Cu)	mm ² (Stranded Al)	mm ² (Solid Al)	Name	Crimp geometries	Net weight (kg)	Length mm	Width	Height
10-400	16-400	16-240	V1300	Punch, Hexagonal, Oval	3,46	263	88	75

Crimp geometries



V1311-A



Tested and certified hydraulic hand-held tool for crimping Cu-terminals, type KR/KRT 10 mm², KS/KST 10 mm², KRF/KRD/KRT 16-400 mm², KSF/KSD/KST 16-400 mm², Al terminals 16-400 mm² (-240 solid), DIN 46235 10-300 mm², C-sleeves up to 240 mm² total area (C95-120).

Properties:

- fast forward feeding
- crimp force 130 kN (13 tonnes)
- requires low handle force, approx 245 N at max force
- the fork can rotate 180°

mm ² (Cu)	mm ² (Stranded Al)	mm ² (Solid Al)	Name	Crimp geometries	Net weight (kg)	Length mm	Width	Height
10-400	16-400	16-240	V1311-A	Punch, Hexagonal, Oval	4,3	588	150	74

Crimp geometries

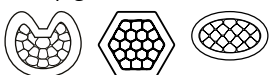

PVX1300/PVX1300DB

Tested and certified battery-powered crimp gun for contact crimping Cu-terminals, type KR/KRT 10 mm², KS/KST 10 mm², KRF/KRD/KRT 16-400 mm², KSF/KSD/KST 16-400 mm², Al-terminals 16-400 mm² (-240 solid), DIN 46235 10-300 mm², C sleeves up to 240 mm² total area (C95-120).



Properties:

- ergonomic design ensures optimum balance in the user's hand
- crimp monitoring with warning light and signal when the correct pressure/full crimp is not achieved
- LED work lighting
- possibility of documentation of each crimp for unique service control
- crimp force 124 kN (13 tonnes)
- crimps/charging: 60-120 depending on size and temperature
- crimp time: 4-12s depending on size
- usage temperature -20°C to +40°C
- Li-Ion Makita, 5.0 Ah, 18V
- charger Li-Ion Makita, charging time 22 min 110-240VAC 50-60Hz
- DUAL: 10 - 300 mm²



Crimp geometries

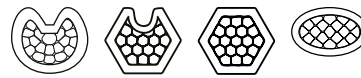

mm ² (Cu)	mm ² (Stranded Al)	mm ² (Solid Al)	Name	Crimp geometry	Net weight (kg)	Length mm	Width	Height	Note
10-400	16-400	16-240	PVX1300	Punch, Dual, Hexagonal, Oval	6,7	412	319	75	Delivered in standard case
10-400	16-400	16-240	PVX1300DB	Punch, Dual, Hexagonal, Oval	7,3	412	319	75	Delivered with 2 batteries
10-400	16-400	16-240	PVX1300-ADV	Punch, Dual, Hexagonal, Oval	14,2	412	319	75	Delivered in case advanced
10-400	16-400	16-240	PVX1300DB-ADV	Punch, Dual, Hexagonal, Oval	14,2	412	319	75	Delivered with 2 batteries and case adv.
10-400	16-400	16-240	PVX1300-WOBC- ADV	Punch, Dual, Hexagonal, Oval	12,4	412	319	75	Delivered in case adv. and without Battery/ Charger
10-300	16-400	16-240	PVX1300-US	Punch, Dual, Hexagonal, Oval	6,7	412	319	75	Delivered with battery and US-charger
10-300	16-400	16-240	PVX1300DB-US	Punch, Dual, Hexagonal, Oval	7,3	412	319	75	Delivered with 2 batteries and US-charger
10-400	16-400	16-240	PVX1300-WOBC	Punch, Dual, Hexagonal, Oval	4,8	412	319	75	Delivered without Battery/Charger



Accessories for crimping overhead lines with V1300, V1311-A and PVX1300

Crimp dies for AlMgSi (Super B) and Al59

Supplied in pairs. Hexagonal crimping. Use inner die holder V1316, and outer die holder V1318.



Outer die holder V1318, BNP dies, inner die holder V1316.

mm ² Overhead line	Name	Number of crimps	Net weight (kg)	Die holder required	Note
31-62	B16NP	2x5	0,118	Yes	AlMgSi 31-62 mm ² , FeAL: 62 mm ² , ALUS 50 mm ²
99	B20NP	2x5	0,126	Yes	AlMgSi 99 mm ² , FeAL: 99 mm ²
157	13B26	2x16	0,420	No	Overhead line: 157 mm ² (2x16 crimps)
241	13B32	2x16	0,408	No	Overhead line: 241 mm ² (2x16 crimps)

70

Crimp dies for overhead lines FeAl

Supplied in pairs. BxxFE dies are used for steel sleeves and BxxNP dies are used for Al-sleeves. Use inner die holder V1316 and outer die holder V1318.

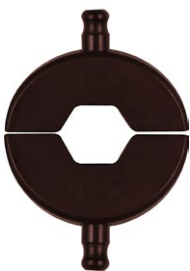

Die pair B16NP

mm ²	Die Fe	Die Al	Number of crimps
62	B6FE	B16NP	2x5
99	B8FE	B20NP	2x5



Tools for Cu terminals 10 - 800 mm², Al terminals 16 - 630 mm² and C-sleeves 6 - 300 mm²



V250



Tested and certified crimp head for crimping Cu-terminals, type KR/KRT 10 mm², KS/KST 10 mm², KRF/KRD/KRT 16-800 mm², KSF/KSD/KST 16-800 mm², Al-terminals 16-630 mm² (-300 solid), C sleeves 6/6-300/300 mm². Used in combination with foot pump P4000 or the electrically powered pump PS710 (battery powered version of PS710E is also available).

Properties:

- working pressure 63 MPa (630 bar)
- crimp force 250kN (25 tonnes)
- large crimp area, 10-800 mm²

mm ² (Cu)	mm ² (Stranded Al)	mm ² (Solid Al)	Name	Crimp geometries	Net weight (kg)	Length mm	Width	Height
10-800	16-630	16-300	V250	Punch, Hexagonal, Oval	4,68	280	111	74

Crimp geometries

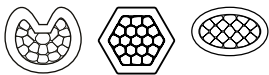

Accessories for crimping overhead lines with V250

Crimp dies for AlMgSi(Super B) and Al59

Supplied in pairs. For joints on overhead lines AlMgSi (Super B) and Al59, hexagonal crimping. Use inner die holder **V2506** and outer die holder **V2508**.



Die holder V2508, BNP dies, die holder V2506.

mm ² Overhead line	Name	Number of crimps	Net weight (kg)
31-62	B16NP	2x5	0,118
99	B20NP	2x5	0,126
157	B26NP	2x8	0,140

70

Crimp dies for overhead lines FeAl

Supplied in pairs. BxxFE dies are used for steel sleeves and BxxNP dies are used for Al-sleeves. Use inner die holder **V2506** and outer die holder **V2508**.

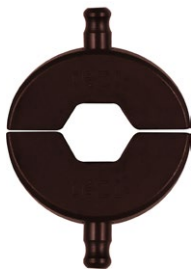

Die pair B16NP

mm ²	Die Fe	Die Al	Number of crimps
62	B6FE	B16NP	2x5
99	B8FE	B20NP	2x5



Storage box L-Alu

Additional storage box for LV1300B and LV250, with space for accessories to crimp Elpress Al-terminals.

Properties:

- material plywood
- interior material polyethylene
- solid, moulded interior



Name	Net weight (kg)	Length mm	Width	Height
L-ALU	5,19	570	467	130



Storage box LV250

Storage box with space for tool V250 and all necessary accessories to crimp Elpress Cu-terminals.

Properties:

- material plywood
- interior material polyethylene
- solid, moulded interior



Name	Net weight (kg)	Length mm	Width	Height
LV250	5,09	570	467	130



Shearbolt terminals for low and medium voltage

Shearbolt terminals.....	2
Shearbolt connectors 10 - 240 mm ² (pre-assembled screw).....	3
Shearbolt connectors 10 - 630 mm ² (reversible screw).....	3
Filler piece.....	4
Shearbolt terminals 10 - 630 mm ² (pre-assembled screw).....	4
Shearbolt terminals 10 - 630 mm ² (reversible screw).....	5
Screw branch clamps.....	5
Counterhold tool.....	5

Shearbolt terminals

Shearbolt terminals up to 36 kV

Elpress shearbolt terminals are available as through connectors and terminals for:

- stranded and solid Al and Cu cables
- round cross section 10 to 630 mm²
- sector cross section 16 to 240 mm²



SL240N-12

The screws used are made of brass, that has the advantage of providing a lower friction compared to aluminium or steel screws. This makes it easier for the user to perform the installation. Installation tools can be a socket wrench or an impact wrench with torque force >100 Nm. We recommend that the fitter uses a counterhold tool to secure the shearbolt terminal more easily when tightening the screws.

Handles multiple area steps

The advantages of shearbolt terminals are that installation can be done easily without any heavy special tools and that they can manage several area steps in the same through connector/terminal, for example 10-50 mm². The user gets a reduced range of products and a flexible solution.

Shearbolt terminals are made of hardened aluminium with an alloy that allows both copper and aluminium cable to be joined, while preventing the occurrence of galvanic corrosion. To reduce the number of terminal variants, screw terminals are supplied with reduction washers that allow the use of two different bolt sizes.

Washers are always needed for connecting terminals with screw joints to busbars.



Use a socket wrench to tighten the screws. It is also possible to use an impact wrench.

SC50R50S

On the SC50R50S through connector, the screws are threaded into the sleeve and can handle all their cable areas on one thread length. SC50R50S is also suitable as a screen connector for 10-35 mm² Cu/Al.



Through connector SC50R50S with pre-assembled screws.

Labelling

Elpress marking of shearbolt terminals shows logo, product name, cable area (for stranded and solid conductors) and shearbolt installation order. The terminal palm is marked with screw size M-thread for bolted joints.

Cat. no. SL70R70S-10-12

SL = Shearbolt terminal
70R = max 70 mm² round conductor
70S = max 70 mm² sector conductor
10-12 = screw size 10 and 12 M thread

Cat. no. SC50R50S

SC = Shearbolt connector
50R = max 50 mm² round conductor
50S = max 50 mm² sector conductor

Screw and washer

The following apply for bright galvanized type nuts and screws, with strength class 8.8, used for connecting terminals with Cu and Al palms:

- Always use a torque wrench to be certain the right torque is achieved. Make sure it is calibrated at regular intervals according to the supplier's instructions.
- Use the recommended torque according to the screw manufacturer's instructions.
- Always use a hard flat washer to reduce friction against the connection surface and the edge pressure, hardness min HB200.
- Install as illustrated.

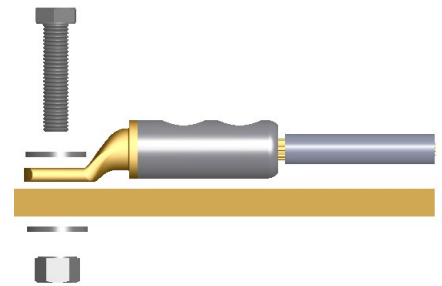

Tightening torque

Recommended tightening torque for wet lubricated screws and nuts of bright galvanized zinc type with strength class 8.8 and coarse threaded (normal thread), used with corresponding washer for connection of terminals with Cu- and Al palm. See table in Chapter 12.

Shearbolt connectors 10 - 240 mm² (pre-assembled screw)

Properties:

- screw material: brass, for minimum friction
- partition
- pre-assembled shear-off screws for easy handling
- voltage range: 1 kV
- meets the requirements of standard IEC 61238-1
- PEN is a filler piece for use when connecting the cable's copper screen

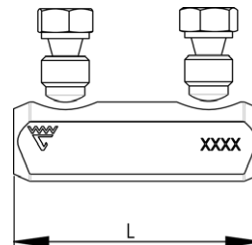
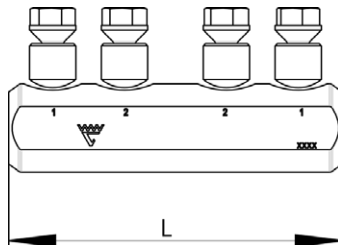

Through connector SC50R50S with threaded screws.

Cable type round mm ²	Cable type sector mm ²	Name	Screen conductor	Screen conductor (with filling piece)	d	D	L	Pcs/pack
10-50	16-50	SC50R50S	10-35		10,7	17,3	62	10
35-95	50-95	SC95N	57-95	16-50 (SC95N/PEN)	16,8	23,0	69	1
70-150	70-150	SC150N	120-146	21-95 (SC150N/PEN)	19,5	23,0	80	1
95-240	120-240	SC240N		29-146 (SC240/PEN)	25,0	33,1	144	1

s = strip length

Shearbolt connectors 10 - 630 mm² (reversible screw)

Properties:

- screw material: brass, for minimum friction
- partition
- reversible shear-off screws
- voltage range: 1 kV to 36 kV
- meets the requirements of standard IEC 61238-1
- PEN is a filler piece for use when connecting the cable's copper screen



8

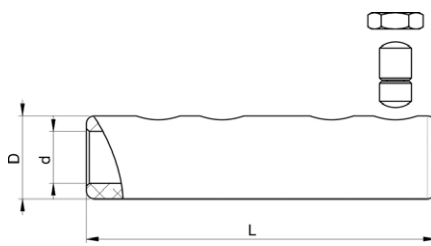

Cable type round mm ²	Cable type sector mm ²	Name	Screen conductor	Screen conductor (with filling piece)	d	D	L	s	Pcs/pack
50-95	50-95	SC95R95S	70-95	16-57 (SC95N/PEN)	16,0	27,0	114	58	1
95-150	95-120	SC150R95S	70-95		16,0	27,0	114	58	1
185-240	120-185	SC240R185S			20,0	33,5	134	64	1
300-400	240	SC400R240S			25,8	41,5	175	87	1
500-630		SC630R			33,0	49,0	210	106	1

s = strip length



Filler piece

To splice the copper screen around the conductors, a filler piece is required that is placed between the screw and the screen. To select the correct filler piece, see table. Requires 2 filler pieces per splice.

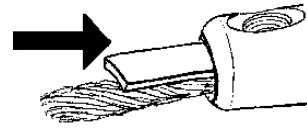

SC95N PEN

Name	Screen conductor	Note
SC95N/PEN	16-57*	*16-50 mm ² (SC95N) / 16-57 mm ² (SC95R95S)
SC150N/PEN	21-95	
SC240/PEN	29-146	

Shearbolt terminals 10 - 630 mm² (pre-assembled screw)

Properties:

- screw material: brass for minimum friction
- pre-assembled shear-off screws for easy handling
- voltage range: 1 kV for SL50N-10-12, SL95N-10-12 and SL240N-10-12, 1-36 kV for the others
- meets the requirements of standard IEC 61238-1
- the terminals are of the bimetallic type

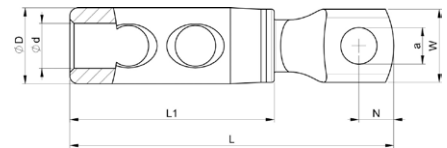
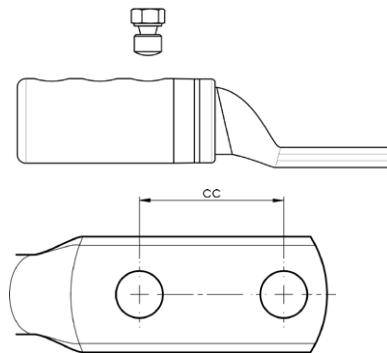

Cable type round mm ²	Cable type sector mm ²	Name	Screen conductor	Screen conductor (with filling piece)	Screw	W mm	d	D	N	cc	a	L	L1	t	s
10-50	10-50	SL50N-10-12	10-35		M10, M12	25,5	12	20/17,3	12,5	13	87	44	5,9	32	
35-95	35-95	SL95N-10-12	57-95	16-50 (SC95N/PEN)	M12, M10	27,3	16	17/23	12,5	13	96	52,5	4,7	56	
120-240	120-240	SL240N-10-12		29-146 (SC240/PEN)	M12, M10	31,5	25	38/33,1	15	13	144,5	86	7,6	76	
185-240		SL240R-12-16			M12, M16	30	20	33,5	15	12	134	79	7,9	75	
185-240		SL240R-12X2-40			M12x2	31,5	20,0	33,5	15	40	12	174	79	7,9	75
300-400		SL400R-12X2-40			M12x2	42	25,8	41,5	15	40	12	210	103	9,6	99
630		SL630B-12X2-40			M12x2	55	33,0	49,0	17	40	12	218	115	11,7	108

t = palm thickness, s = strip length



Shearbolt terminals 10 - 630 mm² (reversible screw)

Properties:

- screw material: brass for minimum friction
- reversible shear-off screws
- voltage range: 1 kV to 36 kV
- meets the requirements of standard IEC 61238-1
- the terminals are of the bimetallic type for best functionality

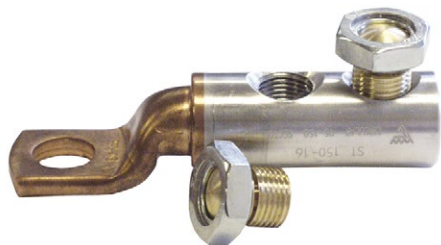

Shearbolt terminal

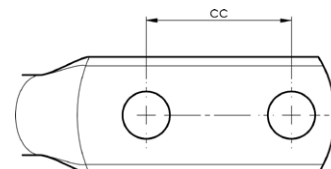
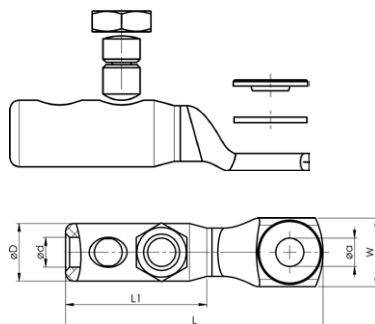

Cable type round mm ²	Cable type sector mm ²	Name	Screen conductor	Screw	W mm	d	D	N	cc	a	L	L1
10-70	25-70	SL70R70S-10-12	10-57	M10, M12	25,5	11,0	21	12,5	12	97	59	
95-150	95	SL150R95S-10-12	70-95	M10, M12	26	16	27	12,5	12	116	75,5	
95-150	95	SL150R95S-12X2-40	70-95	M12x2	30,5	16	27	15	40	12	172	75,5
185-240	120-185	SL240R185S-12-16		M12, M16	31,5	20	33,5	15		16	134	78,5
300-400	240	SL400R240S-16		M16	41,5	25,8	41,5	21		16	182	103
300-400	240	SL400R240S-20		M20	41,5	25,8	41,5	21		20	182	103
300-400	240	SL400R240S-00			41,5	33	49				187	103
500-630		SL500B-630B-12X2-40		M12x2	55	33	49	12	40	12	218	115
500-630		SL630R-1			55	33	49				243	129
500-630		SL630R-16		M16	55	33	49	30		16	241,5	129
500-630		SL630R-14		M14	55	33	49	30		14	243	129
500-630		SL630R-12X2-40		M12x2	55	33	49	15	40	12	243	129

t = palm thickness, s = strip length

Screw branch clamps

Screw clamps for earthing applications. Enables branching of reinforcing bars with a stranded earth line in Cu or Fe.

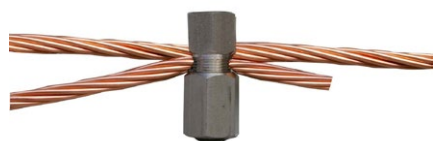

Name	Pcs/pack
SBC50	1

Counterhold tool

Counterhold tool for stable and safe installation of shearbolt terminals. Tools are made from durable material and are easily adjustable for terminals up to 400 mm².



ISL2201

Name	Pcs/pack
ISL2201	1



Insulation kit for splicing

Heat shrink connectors - Shearbolt connectors with heat shrink insulation, 1kV	2
Shearbolt connectors with heat shrink insulation, 1kV	2
Heat shrink connectors - Crimp connectors with heat shrink insulation, 1kV.....	3
Crimp connectors with heat shrink insulation, 1kV	3
Complete joint kit for crimping Al 50-240 mm ² , 1 kV	3

Heat shrink connectors - Shearbolt connectors with heat shrink insulation, 1kV

Complete kits - click & heat

Complete kits for easy splicing of 1 kV plastic insulated 3-, 4- and 5-conductors.

The kit consists of shearbolt connectors with partition and heat shrink insulation. The connection between the cable and the through connector is done by means of screws in a shearbolt terminal. Insulation is done with suitable heat shrink insulation.



Kit for 5-conductor cable.

This is how it works:

- The cable conductor is spliced with a shearbolt connector fitted with torque screws that shear when the correct torque is reached.
- The different phase conductors are insulated with heat shrink insulation of polyolefin.
- The insulation is internally coated with adhesive that melts when heated
- When the adhesive is pressed forward out of the shrunken body, the installation is finished and the joint becomes entirely watertight.
- Sector-shaped conductors do not need to be rounded.
- With the attached filler piece you can easily splice a 3+1 cable to a 4G cable.

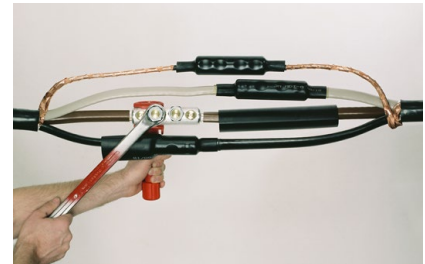

Conductors are spliced using shearbolt connectors. Tighten the screw using a socket wrench, until it shears in the cut-off groove.



Shrinkage of the insulation is achieved by using heat.

Shearbolt connectors with heat shrink insulation, 1kV

Kit for splicing 3-, 4- and 5-conductor cable according to IEC 60228. For both Cu/Al solid and stranded conductors.



Cable type round mm ²	Cable type sector mm ²	Name	Note
10-50	16-50	KSC50N-1-4HS	1 outer jacket, 4 SC50N, 4 inner tubes and abrasive cloth.
10-50	16-50	KSC50N-1-5HS	1 outer jacket, 5 SC50N, 5 inner tubes and abrasive cloth.
35-95	50-95	KSC95N-1-4HS	1 outer jacket, 4 SC95N, 4 inner tubes and abrasive cloth.
35-95	50-95	KSC95N-1-5HS	1 outer jacket, 4 SC95N, 5 inner tubes and abrasive cloth.
70-150	70-150	KSC150N-1-4HS	1 outer jacket, 4 SC150N, 4 inner tubes and abrasive cloth.
70-150	70-150	KSC150N-1-5HS	1 outer jacket, 5 SC150N, 5 inner tubes and abrasive cloth.
95-240	95-240	KSC240N-1-4HS	1 outer jacket, 4 SC240N, 4 inner tubes and abrasive cloth.
95-240	95-240	KSC240N-1-5HS	1 outer jacket, 5 SC240N, 5 inner tubes and abrasive cloth.

Heat shrink connectors - Crimp connectors with heat shrink insulation, 1kV

Complete kits - crimp & heat

Connector kit for splicing 1 kV plastic insulated 4G or 5G cable of stranded Al conductor 16-25 mm², and for splicing or transitioning to Cu 10-16 mm² class 1, 2, 5 or 6.

The kit consists of heat shrink insulation and joint sleeves, which can take a wide range of cable. The concept includes a through connector for transition between the copper cable and the aluminium cable. Used to splice Al cable for lighting and services.

You only need one tool to crimp through connectors and you can choose between a hand tool or a crimp die with an open matrix that fits in Elpress 6-tonne tool systems.

This is how it works:

- The conductors are spliced with sleeves AS1625, AKS1625-1016 or KSF16.
- Use Elpress pliers EW EW1025, or TB die pair TBKA9-11.5 with 600 system.
- The inner and outer tubes of the insulation are dimensioned which means they can be easily applied and then shrunk using heat.
- The length of insulation is adapted to safely cover the cable's primary and sheath insulation
- The insulation is thick-walled and coated with a lot of adhesive that makes the joint waterproof and robust in the face of external influences.
- Meets the requirements in SS-EN 50393, EBR KJ 24:89 The through connectors are tested and approved according to EN 61238-1.



Kit for 4G cable.



Kit for 5G cable.



Shrinkage of the insulation is achieved by using heat.

Crimp connectors with heat shrink insulation, 1kV

Kit for splicing 4- or 5G cable of stranded Al-conductor 16-25 mm² according to IEC60228, and for splicing or transitioning to Cu 10-16 mm² class 1, 2, 5 or 6. Meets the requirements in SS-EN 50393, EBR KJ 24:89



Stranded Al mm ²	mm ² (Cu)	Name	Tool	Pcs/pack	Note
16-25	10-16	KHS-AKS1025-4	V600, EW1025	4	Contents: 1 outer jacket, 4 AKS16-25-1016, 4 inner tubes and abrasive cloth.
16-25	10-16	KHS-AKS1025-5	V600, EW1025	5	Contents: 1 outer jacket, 5 AKS16-25-1016, 5 inner tubes and abrasive cloth.
16-25		KHS-AS1625-4	V600, EW1025	4	Contents: 1 outer jacket, 4 AS1625, 4 inner tubes and abrasive cloth.
16-25		KHS-AS1625-5	V600, EW1025	5	Contents: 1 outer jacket, 5 AS1625, 5 inner tubes and abrasive cloth.

Complete joint kit for crimping Al 50-240 mm², 1 kV

Joint kit for splicing Al conductors 50-240 mm². MultiCrimp Punch crimping for low voltage applications (1 kV) according to IEC 60228, with the 1300-system.



mm ²	Cable type round mm ²	Cable type sector mm ²	Name	Note
50-95	50-95	50-95	KHS-AS5095-1-4	1 outer heat shrink tube, 4 connectors, 4 inner heat shrink tube, 1 cleaning kit and manual
120-150	120-150	120-150	KHS-AS120150-1-4	1 outer heat shrink tube, 4 connectors, 4 inner heat shrink tube, 1 cleaning kit and manual
185-240	185-240	185-240	KHS-AS185240-1-4	1 outer heat shrink tube, 4 connectors, 4 inner heat shrink tube, 1 cleaning kit and manual

Cutting and insulation stripping tools

Cutting and stripping tools.....	2
Tool for cutting and stripping insulation 0.02 - 16 mm ²	3
EMBLA / EMBLA (right-angled handles).....	3
Accessories EMBLA.....	4
Tool for stripping insulation on cables Ø 2.5 - 40 mm.....	5
TOR and ODEN	5
Tool for cutting and stripping conductors 0.5 - 6 mm ² and cutting up to Ø 20 mm ²	6
SCT001, CT10, CT20 and UP-B41.....	6
Tool for cutting cable up to Ø 80 mm.....	7
HKS34, HKS50 and Blade for HKS50	7
HKS62, HKS80, HKS35F and HKS60F	8
Stripping tool for removing layers of PEX cables Ø 10 - 50 mm.....	9
FBS1722	9
Stripping tool for PEX insulation on medium voltage cable.....	10
FBS1723	10
Battery-powered cable cutters	11
PCT54C	11
Hydraulic hand-held cable cutters and cable cutter heads	12
KL2585, HKL40, KL40, HKL55, KL55, HKL85 and KL85.....	12
Technical Specifications.....	13

Cutting and stripping tools

Stripping tools

To strip insulation from cable there are, for example, the Embla, Tor and Oden ranges, that strip from approx. 0.02 mm² up to approx. Ø 40 mm cable. The tools are characterised by high precision, ergonomic adaptation, user friendliness and reliability.



EMBLA, ergonomically adapted cutting and stripping tool.



The ODEN stripping tool can be used in one easy operation.

Cutting tools

Tools are available in several variants for cutting Cu and Al cable up to approx. Ø 85 mm. In addition to the simplest mechanical tools that cut cable up to Ø 20 mm, there is a wide range of hydraulic tools for cutting cable up to approx. Ø 85 mm.

The size of the conductor that the tools can handle mainly depends on the type of conductor to cut; whether it is a low or medium voltage cable and whether it is, for example, a solid Class 1, flexible Class 5 or stranded Class 2 conductor. The hardness of the conductor's material also affects the results. For example, the PKL54C is capable of cutting type Cu FKKJ 4 x 95 mm² low voltage cable or Al AKKJ 4 x 240 mm² or medium voltage cable type Al AXLJ 3 x 150 mm². The insulation takes some space on the medium voltage cable, which is why it can be restrictive.



Battery powered cutting tool PKL54C.

Tools for PEX cable

For preparation of medium voltage cables, 12-24 kV, and removal of conducting layers and PEX insulation, tools FBS1722 and FBS1723 are available.



Stable FBS1722 stripping tool delivers better and smoother results than most other stripping tools.



Tool for cutting and stripping insulation 0.02 - 16 mm²

Properties:

- cutting capacity (EMBLA S, standard cassette): - single core conductor 1.5 mm² (AWG 16), - multi-stranded conductor 10 mm² (AWG 8)
- Versatility: The simplicity and ability to change the stripping cassettes allow stripping of most modern insulation materials. The operating range is the widest found in this type of tool.
- Precision: Fine-adjustment allows stripping of even thin insulation without conductor damage. When stripping is complete, the stripping blades are opened and kept open during the blade return so that the cable can be removed from the tool, easily and without scratches.
- Ergonomics: Specially formulated shape, soft rubber inserts in the fixed handle, low friction, optimized handle width, angled head and low weight ensures comfortable work with the lowest load.
- Long life: Stripping cassettes and cutting blades can be replaced for long tool life.
- Reliable: Tested for over 150,000 cycles. Made of high strength plastic with double strength compared to standard PA6 (nylon).



EMBLA

Stripping and cutting tools.

Embla is available in 3 versions:

EMBLA S,

- with stripping blade, straight blades for PVC insulations 0.02-10 mm² (AWG 34-8)

EMBLA V,

- with stripping blade, V-shaped blades, for harder insulations 0.1-4 mm² (AWG 28-12)

EMBLA 16,

- with stripping blade, oval-shaped blade, for 4-16 mm² (AWG 12-5)

mm ²	AWG	Name	Net weight (kg)	Length mm	Width	Height
0,02-10	34-8	EMBLA S	0,184	191	123	20
0,1-4	28-12	EMBLA V	0,18	191	123	20
4-16	12-6	EMBLA16	0,182	191	123	20



EMBLA (right-angled handles)

Stripping and cutting tools with right-angled handles.

mm ²	AWG	Name	Net weight (kg)	Length mm	Width	Height
0,02-10	34-8	EMBLA RA S	0,136	144	168	23
0,1-4	28-12	EMBLA RA V	0,136	144	168	23
4-16	12-6	EMBLA RA 16	0,136	144	168	23



Accessories EMBLA

EMBLA and EMBLA RA can be supplemented with the following stripping cassettes for different types of cable sizes and insulation. The cassettes can be quickly and easily changed.



EMBLA S-cassette



EMBLA V-cassette



EMBLA 16-cassette

EMBLA SP S

- with stripping blade, straight blades, for PVC insulation 0.02-10 mm² (AWG 34-8)

EMBLA SP V

- with stripping blade, V-shaped blade, for harder insulation 0.1-4 mm² (AWG 28-12)

EMBLA SP 16

- with stripping blade, oval-shaped blade, for 4-16 mm² (AWG 12-5)

mm ²	AWG	Name	Net weight (kg)
0,02-10	34-8	EMBLA SP S-CASSETTE	0,002
0,1-4	28-12	EMBLA SP V-CASSETTE	0,002
4-16	12-6	EMBLA SP 16-CASSETTE	0,002



Tool for stripping insulation on cables Ø 2.5 - 40 mm



Three stripping functions.

TOR

Cable stripping tool for cable insulation Ø 4.5 - 40 mm

Properties:

- two interchangeable hooks for different cable diameters
- locked positions for cross, longitudinal and spiral sections
- stripping: cable diameters 4.5 - 40 mm, insulation thicknesses up to 4.5 mm

Max Ø conductor	Name	Net weight (kg)	Length	Width	Height
4,5-40	TOR	0,206	150 (167)	42 (52)	31 (31)

Dimensions: Small hook / (large hook)

Accessories TOR



mm²	AWG	Name	Net weight (kg)
4,5-40	11-1	TOR SP KNIFE	0,001
20-40	4-1	TOR SP BIG HOOK	0,04
4,5-25	11-3	TOR SP SMALL HOOK	0,04

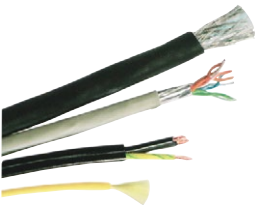

ODEN strips signal, telephone, audio, instrument, data cable etc.

ODEN

Stripping tool to strip insulation from cables Ø 2.5 - 11 mm.
Used for signal, telephone, audio, instrument, data cable and similar.

Properties:

- fine-adjustment and adjustment are performed with a nine-position setting wheel
- stripping: cables Ø 2.5-11 mm, up to 1.0 mm thick outer layers
- flexible: strips or removes the outer layer on most multi-conductors and optical cables up to Ø 11 mm

Max Ø conductor	Name	Net weight (kg)	Length	Width	Height
2,5-11	ODEN	0,043	91	40	19

Accessories ODEN



Name	Net weight (kg)
ODEN SP KNIFE	0,0001

Tool for cutting and stripping conductors 0.5 - 6 mm² and cutting up to Ø 20 mm²



CE



SCT001

Stripping and cutting tool for cutting and stripping conductors 0.5 - 6 mm².

Properties:

- material: high-quality steel
- cuts 0.5-6 mm² (20-10 AWG)
- strips 0.5-6 mm² (20-10 AWG)
- light and versatile
- lockable setting

mm ²	Max ϕ conductor	AWG	Name	Net weight (kg)	Length mm	Width	Height
0,5-6	2	10-20	SCT001	0,102	140	65	10



CE



CT10

Cable cutter for cutting cable up to approx. Ø 10 mm.

Properties:

- cuts Cu and Al cable up to approx. Ø 10 mm
- not intended for cutting steel
- small and manageable
- tempered forged steel cutting blade
- design of the blade inserts provides a clean cut surface

Max ϕ conductor	Name	Net weight (kg)	Length mm	Width	Height
10	CT10	0,16	165	50	15



CE



CT20

Cable cutter for cutting cable up to approx. Ø 20 mm².

Properties:

- cuts Cu and Al cable up to approx. Ø 20 mm
- not intended for cutting steel
- sturdy and comfortable handle grip
- tempered forged steel cutting blade
- design of the blade inserts provides a clean cut surface

Max ϕ conductor	Name	Net weight (kg)	Length mm	Width	Height
20	CT20	0,471	240	78	21



CE



UP-B41

Cable cutter for cutting cable up to approx. Ø 15 mm.

Properties:

- cuts multi-stranded Cu and Al conductors.
- not intended for cutting steel
- small and manageable
- high quality, professional tool
- design of the blade inserts provides a clean cut surface
- minimal power requirement

mm ²	Max ϕ conductor	AWG	Name	Net weight (kg)	Length mm	Width	Height
95	15	4/0	UP-B41	0,357	255	25	70



ELPRESS

Tool for cutting cable up to \varnothing 80 mm

Not for steel wire and wire reinforced cable.



HKS34



Cable cutter for cutting cable up to approx. \varnothing 34 mm.

Properties:

- cuts normal types of Cu and Al cable
- cuts alloyed AC overhead line and BLX up to a diameter of 241 mm² (not FeAl)
- comes with durable textile bag

Max \varnothing conductor	Name	Net weight (kg)	Length mm	Width	Height
34	HKS34	0,908	350	185	60



HKS50



Cable cutter for cutting cable up to approx. \varnothing 50 mm.

Cutting tool for steel and Cu/Al cable with interchangeable blades. HKS50 is supplied with universal blade UFE1 for Al/Cu, FeAl line, flexible steel line and anchoring cables.

Comes in a sturdy textile bag with instructions for use and cleaning tool for threads.

Properties:

- scissor-motion for the best cut surface on the cut cable
- single-handed operation facilitates installation
- reliable and proven ratchet function
- move blades easily and quickly by releasing two screws
- clearly marked usage area on the blades

Max \varnothing conductor	Name	Net weight (kg)	Length mm	Width	Height
50	HKS50	1,443	350	185	60



Blade for HKS50



UFE2

UFE1



UFEB

UFE

Max \varnothing conductor	Name	Net weight (kg)	Application
50	UFE2	0,13	For Cu/Al, flex. steel line, INOX, FeAl line, screw, anchoring cable, piano wire and solid Cu overhead line.
50	UFE1	0,104	For Cu/Al, flex. steel line, INOX, FeAl line, screw, anchoring cable and solid Cu overhead line.
30	UFEB	0,111	For Cu/Al, flex, steel line, FeAl line and mainly used for cutting data/signal cable.
50	UFE	0,104	For Cu/Al cable, clean cut surface and adapted for most flexible cables. Not suitable for cutting steel.



CE

HKS62

Cable cutter for cutting cable up to approx. Ø 62 mm.



Properties:

- cuts normal types of Cu and Al cable
- cuts alloyed AC overhead line and BLX up to a diameter of 241 mm² (not FeAl)
- comes with durable textile bag

Max Ø conductor	Name	Net weight (kg)	Length mm	Width	Height
62	HKS62	2,005	350	185	60



CE

HKS80

Cable cutters for cutting cable up to approx. Ø 80 mm.



Properties:

- cuts normal types of Cu and Al cable
- comes with durable textile bag

Max Ø conductor	Name	Net weight (kg)	Length mm	Width	Height
80	HKS80	3,199	585	215	65



CE

HKS35F

Cable cutters for cutting cable up to approx. Ø 35 mm.



Properties:

- cable cutter
- cuts normal types of Cu and Al cable
- comes with durable textile bag

Max Ø conductor	Name	Net weight (kg)	Length mm	Width	Height
35	HKS35F	1,59	330	185	60



CE

HKS60F

Cable cutters for cutting cable up to approx. Ø 60 mm.

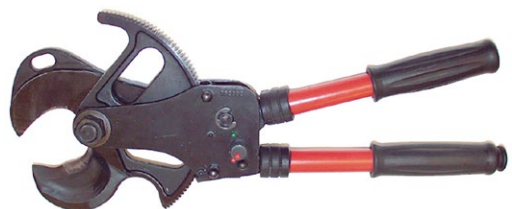

Properties:

- cable cutter
- cuts normal types of Cu and Al cable
- comes with durable textile bag

Max Ø conductor	Name	Net weight (kg)	Length mm	Width	Height
60	HKS60F	3,421	470	185	60



Stripping tool for removing layers of PEX cables Ø 10 - 50 mm



FBS1722

Stripping tool for fixed, outer conductive layers on PEX cables.



Properties:

- FBS1722 contains the stripping tool, 100 g silicone paste and instructions for use, in a padded plastic box
- insulation can be stripped from Ø 10 to Ø 50 mm, which corresponds to up to 800 mm² at 12 kV, 630 mm² at 24 kV and 500 mm² at 36 kV
- the depth of cut is set between 0 and 1.2 mm in 0.1 mm increments using a knob
- stripping can be done up to 25 mm from the edge of the screening and the PEX surface becomes very even
- the blade is hardened, min HRC 55, and specially ground, as well as very easy to replace

Max Ø conductor	Name	Net weight (kg)	Length mm	Width	Height
10-50	FBS1722	0,813	235	200	55

FBS1722 comes with box, silicone paste and instructions for use.

Accessories for FBS1722

Spare parts for the FBS1722 stripping tool.
RS = spare blade and SP = silicone paste.

Name	Net weight (kg)
FBS1722RS	0,006
FBS1722SP	0,115

Stripping tool for PEX insulation on medium voltage cable



FBS1723

Stripping tool for stripping PEX insulation on medium voltage cable.



Properties:

- FBS1723 contains the stripping tool, 100 g silicone paste and instructions for use in a padded plastic box
- the tool is easy to use - rotate the tool with the handle
- stripping can be done from \varnothing 15 to 52 mm which corresponds to cable 12 kV 50-1000 mm², 24 kV 25-1000 mm², 36 kV up to 630 mm² and 52 kV up to 500 mm²
- depth of the blade can be adjusted from 0 to 15 mm
- unlimited stripping length
- the cutting blade is available as a spare part
- adjustable feed in 5 positions, the blade is hardened, min HRC 55, and specially ground and very easy to replace



FBS1723 comes with box, silicone paste and instructions for use.

Max \varnothing conductor	Name	Net weight (kg)	Length mm	Width	Height
15-52	FBS1723	1,072	275	220	65

Accessories for FBS1723

Spare parts for the FBS1723 stripping tool.
RS = spare blade and SP = silicone paste.

Name	Net weight (kg)
FBS1723RS	0,001
FBS1722SP	0,115



Battery-powered cable cutter



CE PKL54C

Electric cable cutter for cutting Cu and Al cable, max. cutting diameter 54 mm.



Properties:

- not intended for cutting steel
- comes in a bag with Li-ion battery, 14.4 V, as well as charger
- tool performs a scissor motion when cutting that provides an optimal cut surface
- built-in fuse as a surge protector
- CE-marked

Max ϕ conductor	Name	Net weight (kg)	Length mm	Width	Height	Note
54	PKL54C	0,001	338	220	120	Charger: 230VAC
54	PKL54C-US	0,001	338	22	12	Charger: 150VAC
54	PKL54C-WOBC	0,001	338	22	12	Without Battery/Charger

Battery powered cutting tool PKL54C.

Hydraulic hand-held cable cutters and cable cutter heads



KL2585 cutting head

KL2585

Hydraulic cable cutting head for copper and aluminum cable.

Properties:

- cuts up to 4 x 150 mm² Cu conductor and ø 85 mm Al, paper and plastic insulated conductors (there may be restrictions depending on the conductor's design and materials)
- cuts steel-reinforced cables, but not steel wire-reinforced cables
- used with foot pump P4000 or electrically powered pump PS710
- supplied in plywood box

mm ²	Max ø conductor	AWG/MCM	Name	Net weight (kg)	Length mm	Width	Height
630	85	1000	KL2585	10,35	250	377	75





HKL40/KL40, HKL55/KL55, HKL85/KL85

A series of cable cutters covering almost all needs when cutting power cables and lines. The cutter heads (KL) are operated with one of Elpress' pumps, e.g. foot pump P4000 or pump PS710. Not for steel wire and wire reinforced cable.



Max ϕ conductor	Name	Net weight (kg)	Length	Width	Height
40	HKL40	6,058	645	165	85
55	HKL55	4,133	560	140	55
85	HKL85	7,6	745	190	72
40	KL40	4,7	285	105	85
55	KL55	3,5	300	110	55
85	KL85	6,7	385	170	75

HKL40, KL40. HKL55 and KL55

Do not cut wire reinforced cable.



HKL85 and KL85

Technical Specifications

HKL40/KL40/HKL55/KL55/HKL85/KL85

Hydraulic manual cutters	HKL40	HKL55	HKL85
Hydraulic cutting heads	KL40	KL55	KL85
Max. opening	ϕ 40	ϕ 55	ϕ 85
Max. cutting force, KN	88	43	55
Max. cutting capacity, examples.			
copper cable	ϕ 40	400 (500) mm ²	630 mm ²
Cu annealed solid conductor		ϕ 20	
Cu rod	ϕ 30		
Aluminium cable	ϕ 40	3x240+95 mm ²	3x240+95 mm ² 630 (800 mm ²)
Al annealed solid conductor		ϕ 25	
ACSR	ϕ 40		
Al bar	ϕ 40		
Telephone cable		ϕ 55	
Steel wire (<180daN/mm ²)	ϕ 11		
Steel rod	ϕ 18		

Deep earthing

Deep earthing system.....	2
Structure and operation of the system.....	3
Deep earthing system FS.....	4
Deep earthing system FSHD.....	5
Accessories for Elpress deep-earthing systems.....	6
Driving sleeves for FS and FSHD deep-earthing systems.....	7
System structure and function - deep earthing.....	8

Deep earthing system

Benefits

Elpress systems for deep earthing have many advantages:

- The ground line has no joints – no risk of contact failure.
- Tip and leading rod are manufactured for a large area range; 16 - 95 mm².
- Can be used for different types of line e.g. soft or hard copper, galvanized or stainless steel.
- When copper line is used, the extension rods act as sacrificial anodes and provide good protection against corrosion.
- Full control over the line and tip is maintained and it is possible to continuously measure the earthing resistance.
- Thanks to the few components of the system, driving is both uncomplicated and reliable.
- The system has a low overall weight compared to other systems.
- The overall cost of a complete earth connection will be lower than that made in a conventional manner.
- Rod length 800 mm for best ergonomics.



Radio base station is an application for Elpress deep earthing systems.

Theory

Elpress' approach is an earthing system without joints. The electrode consists of a copper line that is driven down by a system consisting of 0.8 m long steel rods. A hardened steel tip paves the way for the ground line that is inserted into the steel tip and clamped by the leading rod. For every 0.8 m length of driven line and rod, an extension rod is pushed into the preceding rod. Because the earthing resistance can be continually measured at the other end of the line, one can stop driving when a suitable value is reached and the last extension rod is then withdrawn.

Driving takes place with the aid of a power hammer with an adapted driving sleeve or a sledge hammer and impact sleeve FS62C.



Impact sleeve FS62C

Service life

Elpress deep-earthing system consists of steel rods and a copper line. The steel rods act as sacrificial anodes with relatively high corrosion current against the copper electrode (cathode).

This combination of metal both stabilises and equalises its surroundings. If a lead sheathed cable is located in the soil a few metres from the earth connection, the corrosion current from the lead anode to the Fe+Cu earth connection is 40% less than the value of an earth connection without FE rods. In other words, the lead sheath has a theoretical service life of almost double.

Experiments have shown that after a few months, the corrosion current drops to virtually zero. The explanation is that a special layer – the polarization layer – is formed next to the electrode. The current is thereby reduced and thus also the corrosion. The amount of the reduction depends on the properties of the soil. An AC load should theoretically counteract the corrosion. This means that the practical service life is often longer than the theoretical.

Structure and operation of the system

Elpress systems consist of the following 5 parts:

- hardened steel tip
- leading rod
- extension rod
- driving sleeve/impact sleeve
- earth line (not supplied by Elpress)

This feature is simple

- the earth line is inserted into the hardened steel tip and clamped by the leading rod.
- the extension rods are fitted with a guide pin, which during work is pushed into the preceding rod.
- earthing resistance can be measured continuously. When the appropriate value is reached, driving is interrupted and the last extension tube is withdrawn (and can therefore be reused).

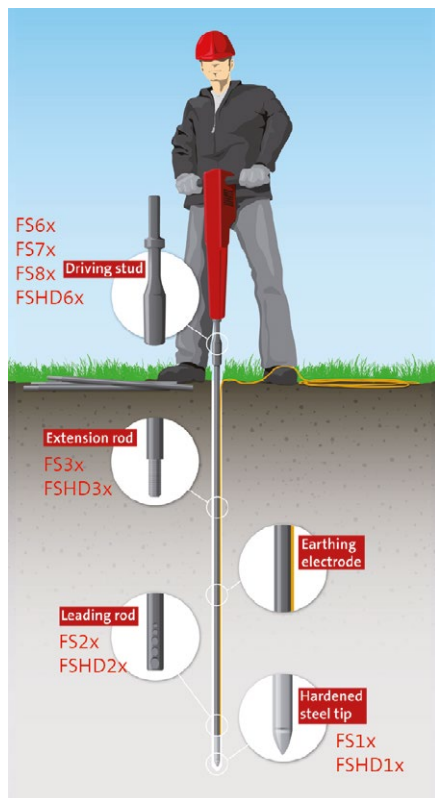

Practical advice:

1. Plan the earth connection. What are the soil conditions? Normal and loose soil - steel pipe \varnothing 17 mm is sufficient. Hard and rocky soil- steel rod \varnothing 21 mm (type HD) should be used. Is a parallel earth connection possible?
2. Determine the soil resistivity. Based on that and the maximum earthing resistance it can be estimated how much line is needed.
3. Start the driving by locking the line into the hardened tip with the leading rod. 16 mm² line should be folded double before the tip is attached. In loose soil, a sledgehammer and impact stud is sufficient. In heavier soil/at greater depth, a power hammer should be used. NOTE: Do not rotate the driving sleeve during the work.
4. Make sure that the line maintains the same speed down into the soil as the rod. If it does not, there are the following possibilities:
 - more rods than line required; the rod may have been bent and then runs parallel to the surface of the soil and the line does not follow the pipe through the ground.
 - the rod continues and the line stops; the line has come loose and can be pulled up or the tip has folded.
 - both stop; stone or rock has been found. If the stone does not shatter after about 10 seconds, you must start over.

In the event of interrupted driving, start again at a distance at least 1.5 times the line length already driven down.

5. Preferably measure the earthing resistance continuously while driving down the earth line. Arrange a parallel earth connection if necessary. Splicing and branching of the earth line is contact crimped by means of Elpress through connectors or branching sleeves and tools.

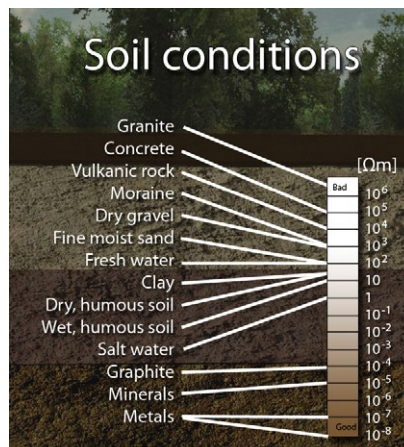

1. Resistivity in different soil conditions.



2. Measurement of ground resistance.



3. The earth line is locked to the hardened steel tip with the leading rod.



Driving starts.

Deep earthing system FS

Elpress deep-earthing system FS consists of 3 parts. Tip (FS1x), leading rod (FS2x) and extension rod (FS3x).



FS1x



Tip, with hardened steel furthest out. Fits FS21 and allows the use of different types of earth line.

mm ²	Name	Net weight (kg)	Length	Pcs/pack
16-70	FS11	0,176	135	5
70-95	FS12	0,176	135	5



FS21



Steel leading rod, equipped with a grooved notch to lock the earth line effectively. For loose and normal soil conditions.

∅	Name	Net weight (kg)	Length	Pcs/pack
17	FS21	0,644	800	5



FS31



Steel extension rod, HD, equipped with a guide pin that fits inside the preceding rod. For loose and normal soil conditions.

∅	Name	Net weight (kg)	Length	Note	Pcs/pack
17	FS31	0,804	870	Length incl. driving cap	5



Deep earthing system FSHD

Elpress deep-earthing system with thicker rods for tougher soil conditions FSHD (HD: "Heavy Duty") consists of 3 parts. Tip (FSHD1x), leading rod (FSHD2x) and extension rod (FSHD3x).



FSHD11



Hardened steel tip intended for hard and rocky ground. Used in conjunction with leading rod FSHD23.

mm ²	Name	Net weight (kg)	Length	Pcs/pack
25-70 (95)	FSHD11	0,254	153	5



FSHD23



Steel leading rod, equipped with a grooved notch to secure the earth line effectively. Designed for hard and rocky ground.

∅	Name	Net weight (kg)	Length	Pcs/pack
21	FSHD23	1,088	800	5



FSHD31



Steel extension rod, HD, equipped with a guide pin that fits inside the preceding rod. Robust rod intended for hard and rocky ground.

∅	Name	Net weight (kg)	Length	Note	Pcs/pack
21	FSHD31	1,224	870	Length incl. driving cap	5

Accessories for Elpress deep-earthing systems



Withdrawal handle FS



Pull handle with grip-friendly design that facilitates withdrawal and allows reuse of the last extension rod FS3x/FSHD3x.

∅	Name	Net weight (kg)	Length mm	Width	Pcs/pack
18,5/22,5	FS41	0,403	230	60	1



Impact sleeve FS



Impact sleeve used when driving using a sledgehammer, or similar, to prevent deformation of the rod end. Specially designed for use with FS21 or FS31 rods.

Name	Net weight (kg)	Length mm	Width	Pcs/pack
FS62C	1,018	110	45	1



Impact stud FS

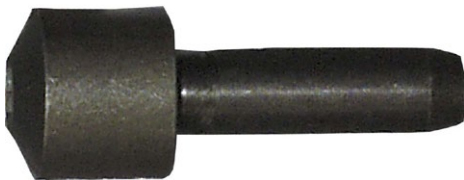

Impact stud used when driving using a sledgehammer, and similar, to prevent deformation of the rod end.

Name	Net weight (kg)	Length mm	Width	Pcs/pack
FS61	0,081	58	22	1



Impact sleeve FSHD



Impact sleeve used when driving using a sledgehammer, or similar, to prevent deformation of the rod end. Specially designed for use with FSHD23/FSHD31 rods.

Name	Net weight (kg)	Length mm	Width	Pcs/pack
FSHD62C	0,93	110	45	1





Driving sleeves for FS and FSHD deep-earthing systems

- specially designed for use with the FS21 and FS31 rods
- protects the end of the rod from deformation when driving with a power hammer
- for FS-type rods with an external diameter of 17 mm
- marked with the catalogue number



Name	Tool	Shaft ∅	Flange length	Total length	Pcs/ pack	Note
FS71C	BBD 12 TS, BHB 14	19	108	305	1	HD version also available for rods with 21 mm outer diameter
FS72C	BBD 12 T-01, Cobra 148/248, Pico 20, RH 571 5L/5LS, RH 658 5L/5LS, BHB 25	22	108	305	1	HD version also available for rods with 21 mm outer diameter
FS73C	TEX 23E, TEX 25E	25	108	305	1	HD version also available for rods with 21 mm outer diameter
FS81C	TE 52, TE 72, TE 92	18		265	1	HD version also available for rods with 21 mm outer diameter
FS83C	USH27	29		310	1	HD version also available for rods with 21 mm outer diameter
FS85C	BHF 25, BHF 30S	27	80	302	1	HD version also available for rods with 21 mm outer diameter
FS88C	TE905/TE805	22		288	1	
FS81D	SDSMax Syst.	18		215	1	
FS74C	TEX 11-DCS, TEX-11-DKS, BR 37, BR 45, DR 19	22	82	280	1	HD version also available for rods with 21 mm outer diameter
FS77C	TEX 31/31s, TEX41/41s, BR 67 UK BR 87 UK	32	160	380	1	HD version also available for rods with 21 mm outer diameter

System structure and function - deep earthing

Earthing

An earth connection is a conductor placed in the soil, with the aim of diverting electrical current from an installation connected to the earth connection and into the surrounding soil.

A customer who buys power takes earthing for granted. This is despite the fact that the use of power without, or with poor, earthing incurs great risks. All power suppliers must have approved earth connections at their installations. This means that voltage surges that can occur for various reasons are led into the ground so that they do not cause damage. Earthing thus functions as, among other things, personal protection, property protection, signal transfer protection, lightning protection and the like.

An approved earthing should have: (1) low electrical resistance, (2) ability to conduct voltage stably (despite weather changes) and (3) long service life, i.e. good resistance to corrosion.

Soil conditions or external conditions?

The importance of the soil as a conductor of electric current is great. The technical specifications and requirements for earthing demonstrate the advantages of deep-earth connections, both as a technical and economic solution, in relation to surface-earth connections.

Current conduction occurs in the soil through electrolytic processes, known as ionic conduction. Solid particles such as gravel are not usually conductive.

The electrical conductivity of the soil therefore mainly depends on the proportion of saline water bound by capillary forces and osmotic pressure in the pores between grains of sand and in hygroscopic humus particles (e.g. clay).

The water in deeper lying ground layers usually has a higher salinity than the water in the surface layer. The higher the moisture content of the soil, the better the conductivity. Soil humidity normally varies between 5-40%. At variations below 14-18%, conductivity deteriorates significantly.

Cold (frost) significantly impairs the ground's conductivity. It is of great importance that all this is taken into account for earth connections or earth connection systems.

Weather conditions - cold, heat, rain and wind - mainly affect the upper layer of the soil (0 - 1.5 m), which therefore exhibits the most powerful variations. The most efficient earthing is thus reached when the electrode is placed deep enough so as not to be affected by changes in soil humidity and temperature.

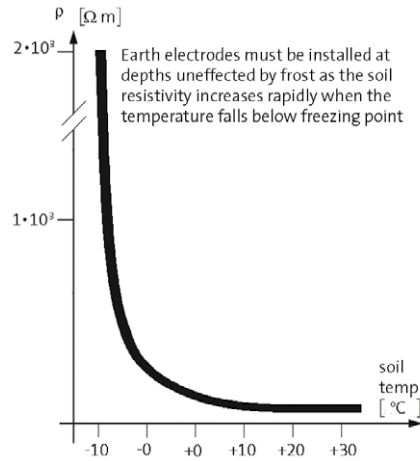

Soil resistance in relation to temperature.

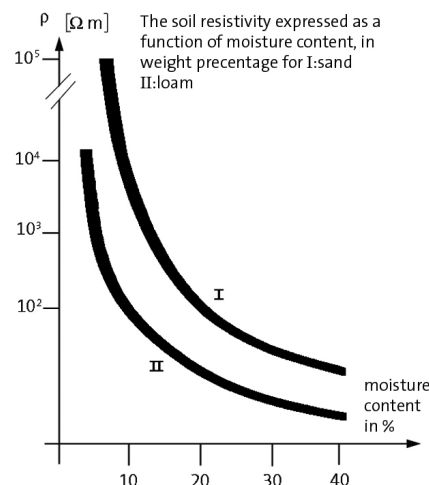

Soil resistance in relation to humidity.

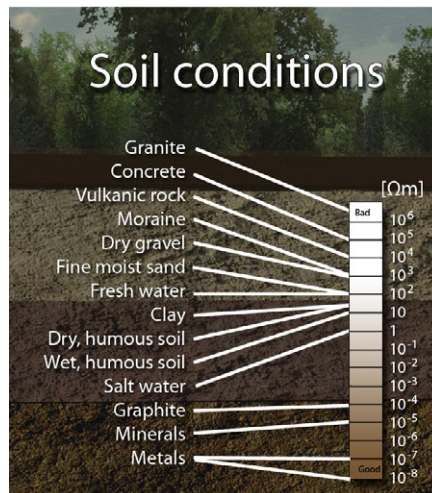

Resistivity in different soil conditions.

Resistivity

The electrical properties of the soil are quality declared by means of its resistivity, which is measured in Ωm (former unit Ωcm , $1 \Omega m = 100 \Omega cm$). Soil with good electrical conductivity thus has low resistivity: 10 - 100 Ωm .

For each case of different soil type, soil resistance must be measured and preferably during several seasons and in different weather conditions. In measurement today almost exclusively voltage compensated electronic resistance bridges are used (measurement method according to Wenner) with 4 connection contacts, 2 of which are for current electrodes and 2 for voltage probes.

The connectors are connected to 4 vertical metal tips that are driven down in a row about 0.3-0.5 m deep a metre apart. (See image)

If the instrument reading is R, the resistivity of the soil is calculated according to the following equation:

$$\rho = 2 \times a \times R \Omega m$$

In unlayered soil, resistivity is independent of the electrode distance a. By increasing distance a, the current penetrates deeper into the ground and the measured resistivity can fall or increase depending on the resistivity of the ground layer at 1 metre's depth. When calculating approximate earthing resistance of the earth connection when the depth is l, the resistivity of the soil must be measured with electrode distance $a \approx 0.75 \times l$.

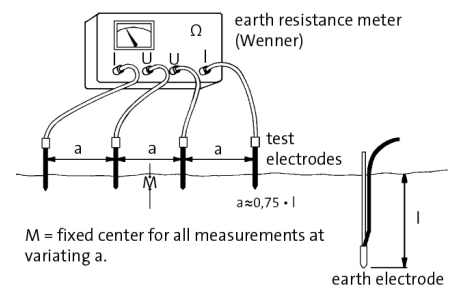

Measurement of ground resistance.



Measuring earthing resistance of the earth connection

Earthing resistance

Due to the high resistance of the soil (109 x resistivity metal) at current bleed in the soil a strong electrical field is formed in the earth connection, which diminishes in strength with distance from the earth connection. At a certain distance, this field can be neglected (removed earth).

The earthing resistance of the earth connection is usually measured with the same type of instrument used to measure the resistance of the soil. However, this measurement requires only one voltage probe and a current electrode (auxiliary earth connection). The location of probes and electrodes varies between different measurement methods. The two methods that follow are a method of accurate technical measurement and a more practical, simplified method.

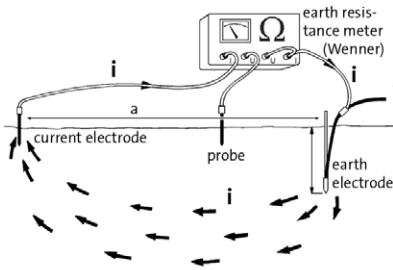

Measuring earthing resistance of the earth connection - Method 1

Method 1

(acc. to the lightning protection standard SS 4870110). This method has a measurement error of +/- 2%.

The summary gives this method:

- The probe and auxiliary electrode are placed in a straight line from the earth connection to be measured as illustrated.
- If the ground is layered, measurement should be carried out in two directions. The largest value is used.

- The reliability of the measurement result depends on the location of the probe/auxiliary electrode. Note the distance table below. These provide normally acceptable measurement accuracy.

earth connection - probe = $0.5a - 0.6a$

earth connection - electrode = a

$a \geq 40$ m if $l \leq 4$ m

$a \geq 10 \times l$ if $l > 4$ m

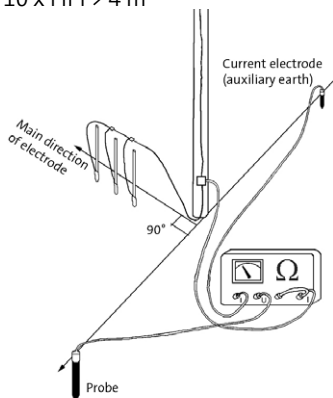

Measuring earthing resistance of the earth connection - Method 2.

Method 2

(acc. to EBR-standard U2:80)

This method normally has a measurement error of more than 2%, but practically is easier to perform than Method 1.

The summary gives this method:

- Probes and electrodes are placed as illustrated, 90° from the main direction of the earth connection.
- The position of the probe/electrode is equal when measuring both an individual earth connection as earth connection system, i.e. at least 80 m from the earth connection.
- Measurement of an earth connection is carried out with an open earth conductor clamp.
- Measurement of the resulting transition resistance on multiple earth connection systems is carried out with the clamp closed and with the measuring line connected on the top of the earth conductor clamp.

With the help of the conductivity and the maximum earthing resistance, which is required by, among other things, the high current regulations, it is possible to estimate how much line may be needed according to the formula:

$$l = p / R$$

l = length in metres

p = soil resistance in ohmmeter

R = earthing resistance in ohms.

In the discussion of the advantage of deep-earth connections compared to surface-earth connections, it should be mentioned here that the earthing resistance of a horizontal surface-earth connection is twice that of a similar line length in a deep-earth connection, i.e.

$$R_0 = 2 \times p / l$$

Parallel connection

Parallel connection of several earth sockets is often necessary for practical reasons to achieve a sufficiently low value of earthing resistance during earthing. In order to limit reciprocal connection between individual earth connections, deep-earth connections shall be installed a distance apart of 1.5 times the depth of the earth connection l . Resulting earthing resistance:

$$R_{res} = k \times R_m$$

where R_m is the mean of the resistance value of the earth connection and k a reduction factor, the value of which is obtained from the following table.

No. of parallel earth connections k for $a = 1.5l$

2	0.60
3	0.40
5	0.25
10	0.13

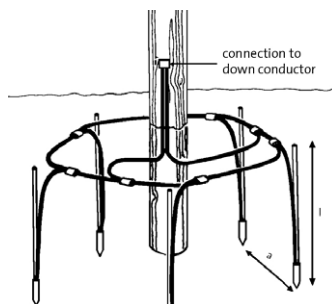

Parallel connection.

From economic aspects it can be pointed out that the diameter of the earth connection has a negligible role when calculating the earthing resistance in deep earthing. This means that when using Elpress deep-earthing systems with copper line, the cost will be lower than when using, for example, conventional systems. What is important in practice in terms of the cable diameter is what currents the system is dimensioned for and what rules and requirements apply.

Examples of applicable requirements: the lightning protection standard states Cu-line min 25 mm², EBR prescribes min. Cu-line 35 mm² for earth connections in overhead line networks and min. 50 mm² for earth connections in ground cable networks.

Corrosion

The service life of an earth connection depends on its resistance to corrosion (rust). The prerequisite for all types of corrosion is an electrolyte fluid that allows the transport of positive metal ions from anode to cathode. At the anode, metal atoms are dissolved in the electrolyte, forming free positive ions - oxidation- and at the cathode these ions are neutralized and deposited on the metal surface - reduction.

In **galvanic corrosion** caused by contact between two metals, the corrosion rate is proportional to the galvanic tension between the metals. A base metal has higher negative potential than a nobler metal and therefore forms the anode in a corrosion process.

There is also a clear correlation between the corrosion rate and ground resistance. The rate of corrosion depends on the composition of the soil. Influencing factors are the pH of the soil, temperature, oxygen content, moisture content and resistivity. These factors affect the corrosion current I_k , which is directly proportional to the rate of corrosion. I_k can be determined by direct measurement with an Ammeter or calculated, if the transition resistance R_0 between the two electrodes is known, according to formula:

$$I_k = U_g / R_0$$

U_g = galvanic voltage

In some cases, R_0 can be measured with a resistance bridge of the same type used to measure the earthing resistance of an earth connection. The rate of corrosion is often expressed in $\mu\text{m}/\text{year}$ where 1 μm represents 1/1000 of 1 mm and denotes the thickness of the corroded away outer metal layer for 1 year. The table below indicates some practical values as guide values for different soil resistivity.

Resistivity	Corrosion
$p < 1 \Omega\text{m}$	100 $\mu\text{m}/\text{year}$
$p < 1-10 \Omega\text{m}$	100-30 $\mu\text{m}/\text{year}$
$p < 10-100 \Omega\text{m}$	30-4 $\mu\text{m}/\text{year}$
$p > 100 \Omega\text{m}$	negligible

General information

Some important comments on contact crimping.....	2
Standards for contact crimping	3
Use and safety instructions	4
Bolt joints.....	6
Service and maintenance	7
Technical information	8
Development - technical services.....	9
General comments on the use of Elpress terminals for voltages of 12 kV and above.....	10

Some important comments on contact crimping



About System Elpress

There is a wide range of electrical terminals today, and it can be difficult to know if you have chosen the right solution for your installation.

A first step is to ensure that a system is chosen, consisting of terminal, tools and a standard conductor.

In order for this combination of material to be classified as a system, there must be common test documentation, a type test according to a standard relevant to the material.

There may also be a need to identify the correct terminal depending on the cable class. Cables are divided into different classes depending on their structure.

With System Elpress you get a complete solution, KRF/KSF in combination with Dual can be combined with all Cu cable classes. Elpress systems for aluminium indented crimping are a robust solution that can be used with all types of Al cables.

Not choosing a system carries great risks. All terminals are designed with respect to a specific tool system. Small differences in dimensions of terminals and tools can lead to serious consequences, such as hot running or fire.

Terminals

Elpress terminals have been developed over 60 years of continuous work to always meet the highest standards.

Our terminals are designed to be able to operate at a continuous temperature of 90°C and to always be able to carry the same load that the relevant cable area can handle.

This means, among other things, that tubes for our KRF/KSF are dimensioned to be adapted to the cable's conductivity. This type of terminal should be crimped with a hexagonal geometry that provides a symmetrical shape that distributes crimp force evenly and ensures that thin strands are not damaged shortening the lifetime of the connection.

Our aluminium terminals are designed according to the same criteria and requirements as mentioned above, and should be crimped with a punch tool that ensures that the aluminium insulating oxide layer is broken and that good points of contact are created between conductors and terminal.

Cables

Elpress terminal systems are designed to be used in conjunction with cables according to IEC 60228. This is an international standard used all over the world and describes the structure and conductivity of a cable (Ω/km). The norm divides cables into classes as shown below.

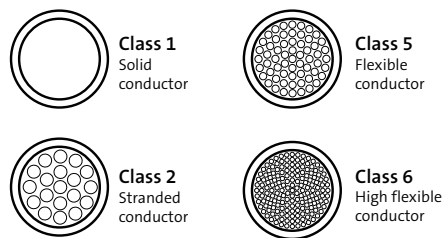

Types of conductor

Cables in each class shall have mechanical and electrical properties that meet the requirements of the norm, which means that they can be used with System Elpress without special adaptation. In addition to the classification of conductors, the differences between cables are mainly in the design of the insulation.



Hexagonal crimping.

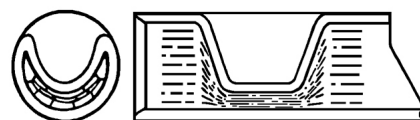

Indented crimping.

Trained users

Another important aspect of a system is a knowledgeable and trained operator. Good and safe work requires knowledge of materials, regulations and the importance of using a system solution. We offer company-adapted training that includes both theoretical and practical parts.

Standards for contact crimping



Standards for electrical terminals

SEK Svensk Elstandard is appointed by the government to be responsible for all standardisation within the electrical area in Sweden.

The Standards are established mainly through international and European collaborations within the International Electrotechnical Commission (IEC) and CENELEC (Comite' Européen de Normalisation Electrotechnique). SEK represents and coordinates Swedish companies and authorities.

These standards are available on the SEK website. There are also manuals that show regulations and recommendations for different types of installations.

For type testing of electrical terminals, the current standard is IEC 61238-1-1, it supersedes all national standards.

It has been active since 1993 and was last updated in 2018 and is thus the standard that best meets the requirements that can be imposed on today's installations. In addition to this, there are a large number of more industry-specific standards for railways or switchgear where, in addition to the requirements of IEC 61238-1-1, there may be a need for vibration and environmental testing.



SEK - Svensk elstandard, <https://elstandard.se/>



IEC, <https://www.iec.ch/>



CENELEC, <https://www.cenelec.eu/>

Tests against standard

Many existing products for electrical terminals are older than IEC 61238-1-1, this does not mean that they have to be retested against the new standard to be acceptable, the standard they were tested against at launch applies. This is rarely a problem as they are likely to be used in installations of the same age. In newer installations with higher demands on current and temperature, it is important to choose materials tested according to current standards.

Crimp results

For a good crimp result, you have to ensure clean conductor surfaces, without visible oxide layers.

A good cable stripper guarantees clean stripping without damage to individual strands, follow Elpress instructions for stripping lengths.

Crimping tools should be checked before starting work, to avoid the risk of injury and to ensure a good result.

The crimp dies are the key to a successful crimping process, whether they are hydraulically or manually operated.

It very important that all tool parts are kept dry and clean and that they are regularly checked for damage.

Damage and/or contamination of tool parts can lead to a deterioration in the end result and shortened tool life.



Use and safety instructions

Instructions and directions

Elpress hydraulic and mechanical tool systems are some of the safest on the market. Safety requires that instructions and directions are available and followed closely. Each Elpress tool is therefore accompanied by detailed instructions on how to use the tool. These instructions should be read carefully before use, in the best interests of the operator.

Correct use of the tools:

- increases productivity
- increases tool life
- ensures the quality of work done
- minimises the risk of accidents

Safety rules

Below are some simple and common rules that we at Elpress recommend all operators to follow:

- Before starting work with a crimp tool, a thorough visual inspection should be carried out. Pump, crimp head, forks, couplings, hoses and other accessories must be checked to ensure that they are faultless and clean. The correct placement of the inserts in the forks should also be checked before starting work.
- All operators must wear personal protective equipment such as A51 gloves, goggles and safety shoes.
- Hydraulic pressure must not be applied to a hose that is heavily bent or knotted. The hose is made for particularly high pressure and cannot be replaced by another type.
- Hydraulic tools must never be carried in the hose or coupling.
- Operate with caution, do not drop heavy objects on the hydraulic hose. This can damage the steel reinforcement and cause leakage. If leakage occurs, oil under high pressure may come into contact and penetrate the skin resulting in internal injury. If this happens, contact a doctor immediately.
- The tools must be serviced and calibrated at regular intervals.
- Make sure that the correct tool or tool insert has been selected for the terminal and conductor to be crimped.
- Check that the installation is unpowered before carrying out work. The tools are not designed for "Live working".
- Keep in mind that there is very high crimp pressure during work. Therefore, never stand in front of a tool in the direction of crimping force.
- Pay attention to the risk of crushing and cutting injuries during work. This applies to all types of crimping tools and cable cutters.
- If there is a suspicion of failure of a crimp system, always contact the Elpress Service Centre.

Check of crimping results

In order to ensure that the tool has achieved the predetermined shape change for each cable terminal, the crimp result shall be measured. This shape change provides both mechanical strength and good electrical properties.

Hexagonal crimping

For terminals and through connectors of copper the following applies:

- The "N" dimension is checked in the direction of the crimp.
- Measure with calipers and compare with the table's "N" dimensions.
- If the measurement result exceeds the "N" dimension (according to the table that follows) after correct contact crimping, contact the Elpress service centre.

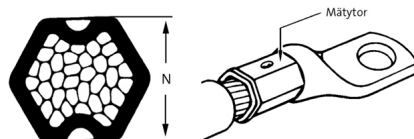

Crimp die table type KRF/KSF with Dual dies (N measurement)

Type KRF/KSF with DUAL dies

KRF/KSF	DB-die nr	max N mm
10	8	6,7
16	9	7,5
25	11	9,0
35	13	10,6
50	14,5	11,8
70	17	13,6
95	20	16,0
120	22	17,7
150	25	20,3
185	27	21,7
240	30	23,9
300	32	25,7
400	38	30,5

Crimp die table type KRF/KSF (N-measurement)

Type KRF/KSF with B-dies

KRF/KSF	Die No.	max N mm
10	8	6,3
16	9	7,3
25	11	8,8
35	13	10,2
50	14,5	11,2
70	17	13,4
95	20	16,4
95	20	15,8 (TB die)
120	22	16,3
150	25	20,1
150	25	20,3 (CB and KB dies)
185	27	20,5
240	30	23,3
300	32	24,5
400	38	30,3
500	42	30,4
630	53	38,4
800	53	38,4

Crimp die table type KRD/KSD (N-measurement)

Type KRD/KSD with B-dies

KRD/KSD	Die No.	max N mm
16	8	6.3
25	9	7.3
35	11	8.8
50	12	10.2
70	14	11.6
95	16	13.0
120	19	15.0 (KB dies)
120	19	15.2
150	22	16.3
185	25	20.1
185	25	20.3 (CB and KB dies)
240	27	20.5
300	30	23.3
400	32	24.5

Crimp die table type KRT/KST (N-measurement)

Type KRT/KST with B-dies

KRT/KST	Die No.	max N mm
10	7	5.9
16	8.5	7.5
25	10	8.2
35	12	10.2
50	14	11.6
70	16	13.0
95	18	14.0
95	18	13.8 (KB dies)
120	19	15.0 (KB dies)
120	19	15.2
150	22	16.3
185	24	17.7
240	26	19.5
300	30	23.3
400	32	24.5



Oval crimping

For Cu branching sleeves, the "h" dimension must be checked. This is done at the maximum height of the crimped oval, preferably with calipers. The measurements are compared to the table below. If the "h" measurement is exceeded, after a contact crimping, contact the nearest Elpress service centre. See measurement points on the image below.

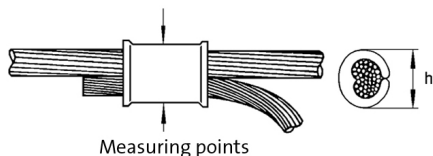

Crimp die table type C sleeves (H-dimensions)

C-die No.	Sleeve	max h mm
5	C6-10	12.5
6	C16-25	15.5
8-9	C25-50	22.0
13	C50-70, C70-95	26.5
15	C95-120	30.8
18	C150-185	44.5
21	C240-300, C23	54.4

Indent crimping

For Al terminals, the measurement "T" must be checked, which is measured at the bottom of the indent that the punch has achieved on the terminal. This is best done with special calipers, contact Elpress if necessary. Compare measured "T" measurement with table. If the "T" measurement is exceeded, after indented crimping, contact the nearest Elpress service centre. See measurement points on the image below.

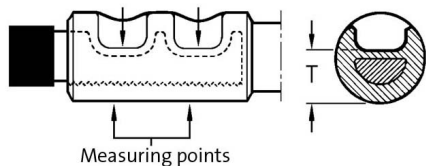

Crimp die table type AK/AS (T-measurement)

Type AS/AK/AKK	Matrix	Punch	max T mm
AS/AK/AKK	Matrix	Punch	max T mm
16	P13M/TP13M	P13D/TP13D	6.8
25	P13M	P13D	6.8
35	P20M	P20D	10.8
50	P20M	P20D	10.8
70	P20M	P20D	10.8
95	P25M	P25D	13.5
120	P25M	P25D	13.5
150	P25M	P25D	13.5
150SOLID	13P29M	13P29D	14.3
185	P32M	P32D	18.4
240	P32M	P32D	18.4
300	P36M	P36/40/44D	21.0
300B	13P37M/P2537M	13P37D/P2537D	22.5
400B	13P37M/P2537M	13P37D/P2537D	22.5
400	P40M	P36/40/44D	22.8
500B	P44M	P36/40/44D	24.5
500A	P2552M	P2552D	31.0
630A	P2552M	P2552D	31.0
630	W60M	W60D	36.0
800	W60M	W60D	36.0
1000	W60M	W60D	36.0
1200	W70M	W70D	41.0

Bolt joints

Bolt joints

Users/installers of bolted connectors always have to adhere to, and follow electrical codes and norms in the local region where they are making such installations. The information below is general and hence, should never be seen as an installation instruction. The installation of a terminal with bolt joint for electrical transmission requires special attention. It is important that this is done in a correct manner, as important as the contact crimping at the other end of the terminal as described above. The joint must achieve a sufficiently high clamping force, distributed in a desirable manner and ensure the electrical properties over a very long time under high and varying loads of different characteristics. It is very important to follow the installation instructions. These are based on theoretical calculations, verified tests and experience from field studies. Tightening must be carried out in a controlled manner using torque tools, where the relevant screw is tensioned to the specified torque. The accuracy of the tool is of great importance. The clamping force of a properly tightened screw shall create a contact area large enough to ensure good conductivity, without the risk of overheating. In order for the clamping force to be distributed evenly and create a sufficiently large contact area, **hard flat washers must always be used**, type BRB HB200 SMS 70, under screw head and nut. See image below. This applies regardless of the hardness of the conductive materials (which are softer than HB200). Otherwise, there is risk of large deformation of the conducting material that reduces the tension, which can increase the risk of inadequate contact area and overheating.

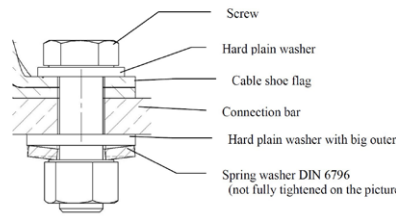

Bolt joint with spring washer.

Mounting the terminal against the connection rail

Max. 2 terminals of the same size on the same screw. Current load should be checked.

Preparatory:

- Clean contact surfaces from dirt, oxide layers and grease using a steel brush and denatured alcohol. This is especially important for aluminium. Surfaces that are tinned, nickel-plated, silver plated must not be brushed.
- Petroleum jelly or contact grease reduces corrosion risk on cleaned surfaces

Fastener selection:

- Screws and nuts of strength class 8.8.
- Greased galvanized screws provide the least dispersion of the pre-tension force.
- Choose stainless A4-80 in environments when there is a high risk of corrosion.

Selection of washers:

- Always select hard flat washers of the BRB, HB200 type.
- The tension washer can normally be excluded. If a tension washer of type DIN 6796 is used, it must be placed between the screw head/nut and the flat washer. It must never be placed directly against an electrical contact surface without a flat washer in between. The flat washer must have an external diameter at least as large as the tension washer.
- 1 spring washer is sufficient and it should be placed on the rear of the busbar, between nut and hard flat washer, see diagram.

Installation:

- The screws must be tightened with torque tools so that tightening is controlled.
- Torque wrenches must be calibrated regularly. Oil the screw when installing. Even if the torque is recorded correctly, the pre-tension force depends entirely on the friction.
- Tightening torque according to the table above. Accuracy better than $\pm 5\%$.
- The terminal palm and busbar may be of different materials.

Al/Al gives a weaker joint. It is important to clean and use contact grease. Tension washer + flat washer can reduce the risk of settlement.

Al/Cu gives a higher risk of corrosion and settlement, use contact grease. Cu/Al provides low risk of galvanic corrosion when the rail is made of Al. Cu/CU provides the best joint, good contact and small risk of settlement.

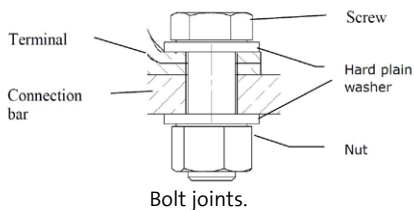

Bolt joints.

Tension washers

The use of different types of locking elements or spring washers often increases the risk of settlement. If a spring washer of type DIN 6796, with a very high clamping force, is positioned and secured between e.g. nut and the hard flat washer, it can provide an increased margin towards excessively high settlement. The diameter of the tension washer should be less than or equal to the flat washer's, even after tightening fully. Otherwise, the risk of settlement at the outer edge of the flat washer increases where the clamping forces are concentrated. **When using spring washers, 1 is sufficient and it is preferably placed on the opposite side of the terminal.**

Recommended tightening torque

Thread	Steel 8.8 *	Steel 8.8 *	Steel 8.8 *	Steel 10.9 *	Steel 10.9 *	Steel 10.9 *	Stainless *	Stainless *	Stainless *
	Mv	Ff	p	Mv	Ff	p	Mv	Ff	P
-									
M5	5,5	6,6	118,0	8,0	9,2	164,0	5,5	6,2	111,0
M6	9,5	9,2	114,0	13,0	13,0	160,0	9,5	8,6	107,0
M8	23,0	17,0	116,0	32,0	24,0	164,0	22,0	16,0	109,0
M10	45,0	27,0	92,0	64,0	38,0	129,0	45,0	25,5	88,0
M12	78,0	40,0	125,0	110,0	56,0	175,0	76,0	37,0	116,0
M16	200,0	75,0	156,0	280,0	110,0	229,0	185,0	69,0	144,0

Mv = tightening torque (Nm)

Ff = pre-tensioning force (kN)

p = flat pressure (N/mm²)

FZB = electroplated + gloss chromed

FZY = electroplated + hard chromed

FZM = FZM= mechanically galvanized

* (FZB, FZY, FZM)

A4/80



Service and maintenance

Service and maintenance

Our service department maintains, repairs, checks, calibrates and certifies Elpress tools and power sources. Following a review of the equipment by the service department, certificates are issued that verify the performance of the tools. To ensure that your crimped terminals maintain a high and even level of quality, regular checks shall be done of the crimping tools.

We offer:

- Contract preventive maintenance, Elpress Basic and Elpress Advance
- Calibration of tools
- Repairs (servicing of tools)
- Rental of crimping equipment



KONTROLLBEVIS / INSPECTION CERTIFICATE			
KontrollMätning / Inspection date	2013-02-08		
Kontrollnr / Inspection No.	020027		
Kund / Customer		Tel / Phone No.	
		Fax / Fax No.	
Kund nr / Customer nr		Director / Direkt No.	
Objekt / Object	Seriernr / Serial No.	Antal / Quantity	Kundens Id-nummer / Customer Id-number
Elpressnr P/N 1300	8794879215	1	
Mätmetod / Measuring method	Kontrollmätning med Elpress / Inspected against Elpressmeter with Elpress		
Avvikning / Note	Rätt av tillstånd hydrauliska och mekaniska		
Mätresultat / Test result	HYDRAULPUMPAR / HYDRAULIC PUMPS		
Max tryck vid kontroll / Max pressure during inspection	100		
Max tryck efter justering och kontroll / Max pressure after adjustment and inspection	107,2		
Övrigt kontroll av / Visual inspection of	<input type="checkbox"/> Yttre ledningar / External ledging <input type="checkbox"/> Inre ledningar / Internal ledging <input type="checkbox"/> Slangar och anslutningar / Hoses and connections <input type="checkbox"/> Elektriska ledningar och anslutningar / Electrical cables and connections		
Beslut / Decision	<input checked="" type="checkbox"/> GODKÄND / APPROVED <input type="checkbox"/> IK GODKÄND / NOT APPROVED		
Mät- och kontrollutrustning för kalibrering med internationella enhetsnamn / The equipment used when measuring and inspecting is calibrated to internationally accepted standards.			
Kontroll utförd av / Inspected by	Lars-Göran Forsström		
Datum / Date	2013-02-13		
Meddelat hos kund / Received by customer			
Signaturen /	Datum / Date		
<small> Jämför med den internationella enheten Mätning med Elpress Elpress AB, Industrihusen 11, P.O. Box 100 - SE-202 24 KRISTINEBERG, Sweden Tel: +46 432 71 71 00 - Service Dept: +46 432 71 71 80 Fax: +46 432 71 71 90 - Support Dept: +46 432 71 71 40 Web: www.elpress.se e-mail: service@elpress.se </small>			

Preventive maintenance

Elpress service offers a flexible service solution for increased security with fast service and high availability. Our service agreements are available in 2 levels, Elpress Basic and Elpress Advance. To sign a service agreement with Elpress means the following:

- Planned and preventive maintenance ensures better performance for your equipment.
- Regular service intervals minimise the risk of unforeseen stoppages by indicating any safety or functional defects and recommending measures to avoid these problems
- Regular service intervals are normally implemented every 12 months for a fixed price
- The price is based on the service level and tool equipment.
- A certificate is issued after the equipment has complied with calibration requirements
- Calibration can also be done on-site at the customer



Calibration with certification of tool

Calibration follows the same points and requirements as Elpress Basic, but it is the customer's responsibility to submit the tool for calibration.

Elpress Basic

This forms the basis of a service agreement and includes the following points:

- General inspection of the tool
- Safety aspects according to declaration of conformity (compliance with the Machinery Safety Directive, Low Voltage Directive, EMC Directive).
- Function test
- Checking of accessories, e.g. crimp dies etc.
- Issue of Certificate
- The inspection follows Elpress final inspection and acceptance inspection requirements.

Elpress Advance

Elpress Advance includes:

- Elpress Basic + corrective maintenance
- Includes calibration with certification and consumables repairs at a fixed price.

Rental of contact crimping equipment

Sometimes the accumulation of work can be greater than can be expected, or individual projects may require more resources than usual and then it is possible to rent equipment at Elpress. When repairing equipment for a company, Elpress can rent tools to the company if required, until the original equipment is repaired and returned.

Purchased a new product?

Send the Product registration form to Elpress and Elpress Basic is included for free the first year.



Information

More information is available from the service department:
<https://www.elpress.net/en/products/system-elpress/service/>

Technical information

Connecting materials

Elpress uses copper, brass and aluminium as terminal materials.

The copper and brass products are electrolytically tin plated for increased corrosion resistance. In a bimetal (copper aluminium) terminal, the copper part is untreated.

Brass

Brass is mainly used for flat pin sleeves in areas up to 6 mm², where good suspension properties are desired. Brass is an alloy of about 70% copper and about 30% zinc and has very good cold form properties.

Copper

The copper used by Elpress for terminals has a purity of at least 99.95 %. Its excellent properties for use in electrical terminals are among the following:

- high conductivity (only silver is better)
- high corrosion resistance
- good formability
- good sealability

In manufacturing the neck of the terminal element is soft soldered in order to obtain as good form properties and good enclosure around the conductor as possible during the contact crimping. This then provides a terminal that exhibits low transitional resistance and good mechanical properties.

Aluminium

The aluminium used for through connectors and cable terminals has a purity of at least 99.7 % and its excellent qualities are:

- low weight
- strong, in relation to its weight
- good electrical conductivity, approximately 60% of the conductivity of copper
- easy to work with

Conductor design

Cable standard IEC 60228 provides:

Information about materials, construction and resistance values for both copper and aluminium conductors.

- Class 1 solid conductor
- Class 2 stranded conductor
- Class 5 flexible conductor
- Class 6 highly flexible conductor

UL-approved terminals

KR/KS, KRF/KSF, KRFS, KRT/KST UL approved in accordance with file no. E205350. UL certified products are delivered with UL marking on the label including the UL file number and/or certification code for control by an UL inspector. The certificate can be downloaded at UL Product IQ.

MCM and AWG cross-reference table to the corresponding area in mm²

MCM No.	Area mm ²	AWG No.	Area mm ²
250	127	36	0,013
300	152	34	0,020
350	177	32	0,032
400	203	30	0,051
450	228	28	0,080
500	253	26	0,13
550	279	24	0,20
600	304	22	0,33
650	329	20	0,56
700	355	19	0,65
750	380	18	0,82
800	405	17	1,04
850	431	16	1,31
900	456	15	1,65
1000	507	14	2,08
1100	557	13	2,62
1200	608	12	3,31
1300	659	11	4,17
1400	709	10	5,26
1500	760	9	6,63
1600	811	8	8,37
1700	861	7	10,6
1800	912	6	13,3
1900	963	5	16,8
2000	1013	4	21,2
		3	26,4
		2	33,6
		1	42,4
		1/0	53,5
		2/0	67,4
		3/0	85,5
		4/0	107

Remarks:

1. The information in this table comes from catalogues published by respected cable providers and does not refer to official standards.
2. The types relating to AWG vary depending on the different design of the conductors, i.e. the number of strands.
AWG > 20 refers to single strand conductors.
AWG ≤ 20 refers to multi stranded conductors.
Exact areas for specific number of strands can be found in cable provider catalogues.

Development - technical services

Development - technical services

Elpress is one of Europe's leading manufacturers of electrical crimping systems and has 60 years of experience in application solutions in everything from nuclear power plants to small electronic devices.

Products in electrical applications are subjected to both mechanical and thermal loads. Elpress invests considerable resources to achieve success through continuous product development towards better value, quality and performance.

For this purpose there is modern laboratory equipment for, among other things:

- High current testing
- Mechanical tensile strength testing
- Cyclic current testing
- Vibration testing
- Corrosion testing
- Resistance determination

The activities also include theoretical studies, prototype development, technical documentation and advice etc. The competence of the staff together with good laboratory and calculation aids is a strong competitive tool both in terms of consultancy services and their own development projects.

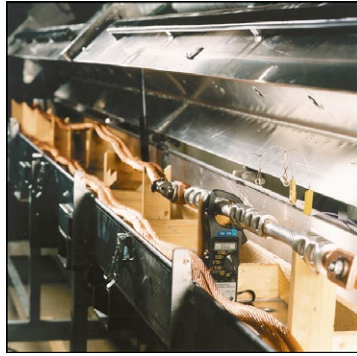

Test of terminals.

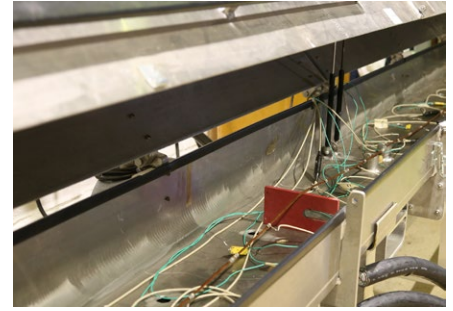

Tests according to IEC 61238-1-1 in own premises

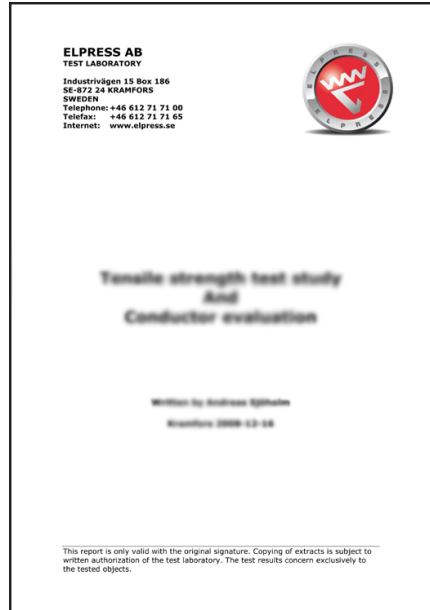

Laboratory report.

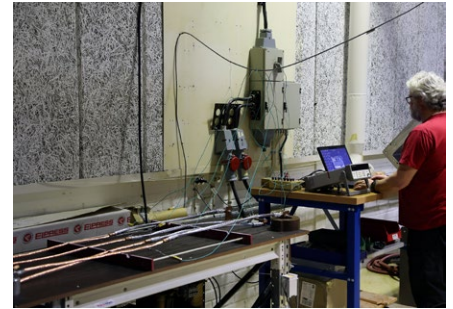

Flexible and customized test setups

General comments on the use of Elpress terminals for voltages of 12 kV and above

Terminals

The modern and easy-to-use cable terminations for 12 to 36 kV PEX insulated cable consisting of prefabricated modules or even fully finished terminations, provide no or very little restriction in the use of terminals with type designations AK, AKK or KRF. This also includes the "top pins" with the type designation AKP.

One detail to take into account when using KRF terminals outdoors is that this terminal is equipped with an inspection hole that must be sealed. Your supplier of cable terminations can provide its specific solution.

Terminals type AK, AKK or "top pin" AKP can today be used on high voltage cable terminations where solutions are available up to 84 kV. In case of doubt, always consult with your cable termination supplier for specific solutions for different issues regarding technical details regarding the design.

When installing cable terminations for oil impregnated paper cable where an oil reservoir is used, manufacturers usually have their own specially designed solutions for the conductor connections.

Terminals type AK

Terminal type AK is used at termination of an Al conductor for connection to busbars and apparatus sockets

Terminals type AKK

Terminals of type AKK are used at the end of an Al conductor for connection to a Cu bus bar.

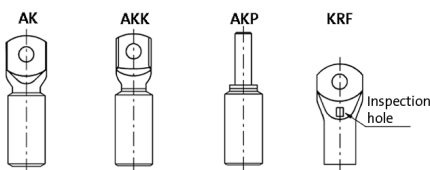

Through connectors type AS

Through connectors type AS used when splicing aluminium-conductors.

Through connectors type AKS

Through connectors of type AKS are used for jointing of Al conductors to Cu conductors.

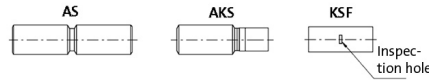

Joint sleeves PEX insulated cable against PEX insulated cable

In Sweden, four types of splice are currently used in the voltage range 12 to 36 kV. These are tape, heat shrink, cold shrink and push-on joints. All these joints are designed to accept AS, AKS and KSF through connectors. No connectors with conical ends are required today.

Different manufacturers have their own solutions that are designed to take care of, for example, the punch holes and the distance between the insulation edge and the through connector.

Always note the joint manufacturer's directions regarding maximum lengths and diameters of the connectors. If you are not sure, or if the installation instructions do not indicate what you are considering, consult your joint supplier.

At higher voltages, e.g. 52 and 84 kV, other requirements are placed on the through connectors depending on the joint design and design. However, there are solutions where "normal" through connectors are used together with filler materials in the voltage range up to 145 kV.

PEX insulated cable against oil impregnated cable

When installing a transition splice between cables with oil impregnated insulation and PEX insulation at voltages of 12 kV and above, connectors with partitions must be used, regardless of the splicing method and make. AKS, KSF-M and AS connectors always have partitions.

Oil impregnated against oil-impregnated cable

When splicing two cables with this type of insulation, connectors of type AS, AKS, or KSF can be used, whether it is an oil tube connector or a "dry" heat shrink connector.



SYSTEM ELPRESS

SYSTEM ELPRESS

System Elpress symbolizes our **cornerstones** – safety and quality. In order to achieve a secure connection, we offer **certified solutions** of the combination cable, terminal and tool.

For perfect crimping connections, **Elpress Academy** offers Crimping Technology training and seminars.



For non-standard solutions you can **consult** us and let our own production and laboratory verify your solution. A preventive **service** maintenance of the tool is the base for the system to work.

Certification, Academy, Consulting and Service is System Elpress – your secure connection!



Certified Tool
EIPRESS

GSA0760
MiniForce
Made in Sweden
V058400910069

US Patent 5,944,322/291
5188954

*We manufacture tested systems for electrical connectors
and their tools. You get a secure connection.*

SYSTEM ELPRESS CERTIFICATION

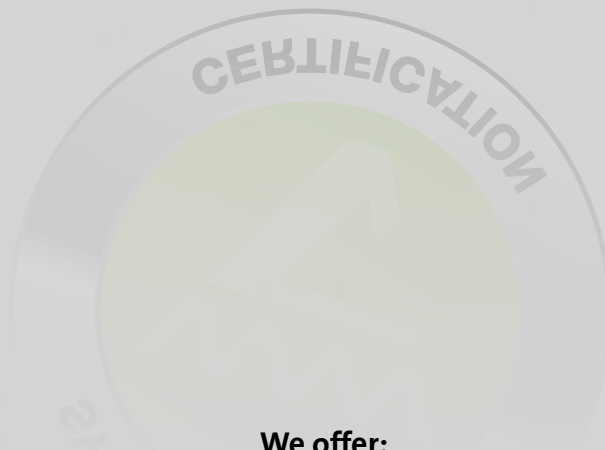

We offer:

- Tool delivered with a calibration certificate
- Verified and tested combination of cable, terminal and tool
- Certified solutions for customized product development
- Product approval in accordance with IEC, UL, DNV and CSA
- Third part quality and environment certification in accordance with ISO9001 and ISO14001



In order to achieve a secure connection we offer certified solutions of the combination cable, terminal and tool.

This is so that you as customer can feel secure when you use our system and be sure that a safe connection will be made when our products are used correctly.

FOR YOUR SAFETY

The System includes:

- Terminal, connector
- Crimping tool
- Correct cable
- Trained and skilled operator

The system is developed and tested in accordance with existing norms and standards, for example IEC.

Product development

- Customized solutions
- Specialized segment solutions
- Leading technology in our industry
- Innovative products





Quality & environment certified and approved according to

- ISO 14001
- ISO 9001
- DNV
- UL





*We have the necessary resources for you
to maintain the highest quality*

SYSTEM ELPRESS CONSULTING



We offer:

- Tests in laboratory
- Problem solving
- Technical and customer support
- Customized terminals and tools
- Audits and validations at your premises



WHY CONSULT US?

We have been developing, manufacturing and marketing complete cable crimping systems for electrical connectors with more than 50 years of experience. We have therefore the best knowledge and equipment for your requirements and demands.

You will have access to:

- Our Technical Departments that designs and develops customized products and solutions according to your requirements.
- Our Production Team who can manufacture unique solutions.
- Our laboratory who can supply for example
 - Electrical tests
 - Mechanical tests
 - Corrosion- and environmental tests

Contact us and let us assist you.







ER LEDANDE S

*A well educated personnel ensures the final quality of products and services.
Our Academy certificate is a Quality Assurance Document between you and your customer.*

SYSTEM ELPRESS ACADEMY



We focus on the following four areas:

- Utility sector and installers
- Transformer manufacturers
- Traction/Train manufacturers
- Wind Power manufacturers



WHO AND HOW DO WE EDUCATE?

Utility and installation personnel

General training for all staff. Provides a general knowledge of crimping in all areas;

- Terminals below 10 mm²
- Cu-connectors over 10 mm²
- Al-connectors from 16 mm²
- Cu-branching
- Bolt connections
- Deep earthing
- Standards and requirement
- Safety and maintenance
- Quality inspection

The program combines theory and practice and concludes with a written test. Course participants will receive certificate after the completion of their training.

Possibility to customize the training so the content fits the needs of the company.

Transformer manufacturers

For operators who work daily in the production. The aim is to train personnel in the special conditions applying in the transformer manufacturing. The training focuses on areas like;

- Management of tools
- Calculations and preparation for crimping
- Work procedure
- Quality inspection
- Safety in use
- Preventive maintenance in daily production

The training consists of a theoretical and a practical part and ends with a written test. Course participants will receive certificate after the completion of their training.

We can provide education for all personnel such as operators, supervisors, designers and quality departments. The education includes a thorough knowledge of calculations, tool selection and management, problems and solutions and quality assessment.



Each training has a level that suits everyone, such as operators, designers, supervisors and quality managers. In addition, there is the possibility to customize the training so that the content fits the needs of the company. You also decide whether the training should be company-based or held in Elpress's training facilities.

Train and vehicle manufacturers

Educate staff in the special demands and external conditions that apply in the manufacturing of rail traffic. The training concerns;

- Management of tools
- Work procedure
- Elpress Dual-technology
- Crimp technique
- Quality inspection
- Safety in use
- Preventive maintenance in daily production

The training consists of a theoretical and a practical part and ends with a written test. Course participants will receive certificate after the completion of their training.

Education for all personnel such as operators, supervisors, designers and quality departments. Provides a thorough knowledge of calculations, tool selection and management, problems and solutions and quality assessment. Completed training gives a certificate.

Wind Power manufacturers

Educate staff in the special demands and external conditions that apply in the manufacture of wind turbines. The training concerns;

- Management of tools
- Work procedure
- Elpress Dual-technology
- Crimp technique
- Quality inspection
- Safety in use
- Preventive maintenance in daily production

The training consists of a theoretical and a practical part and ends with a written test. Course participants will receive certificate after the completion of their training.

Education for all personnel such as operators, supervisors, designers and quality departments. Provides a thorough knowledge of calculations, tool selection and management, problems and solutions and quality assessment. Completed training gives a certificate.



*Preventive maintenance agreements
secure the quality of your connection*

SYSTEM ELPRESS SERVICE



We offer:

- Preventive maintenance agreements
- Calibration of certified tools
- Repairs/maintenance of tools
- Crimping systems for rent
- Sales of spare parts

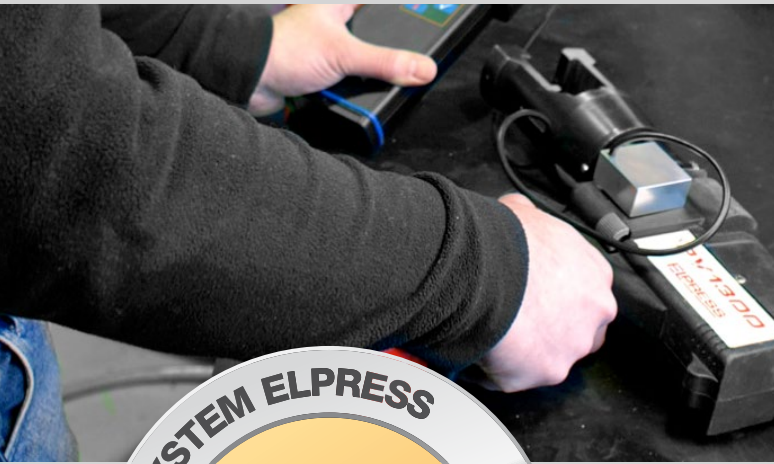

WHAT IS THE BEST SOLUTION FOR YOU?

Preventive maintenance agreements

Our Service offers you a flexible solution for enhanced security, with rapid service and high availability:

- Planned and preventive maintenance guarantees high performance for your equipment.
- Regular service intervals minimize the risk of unforeseen stoppages by indicating any safety or functional defects and by recommending measures to avoid such problems.
- Regular service intervals are normally implemented every 12 months at a fixed price.
- The price is based on the service level solution and equipment.
- A certificate is issued after the equipment has complied with calibration requirements.
The maintenance can be performed at your premisses.

Elpress Basic

Elpress Basic service agreement includes following points:

- General inspection of the tool
- Safety aspects in accordance with declaration of conformity
- Function test
- Checking of accessories, e.g. crimp dies etc.
- Issue of Certificate

The inspection follows Elpress final inspection and acceptance inspection requirements.

Elpress Advance

Elpress Advance service agreement includes following points:

- Elpress Basic + corrective maintenance

Includes the Calibration/certification and wear & tear repairs at a fixed price.

Calibration of certified tools

The calibration follows the same inspection points and requirements as Elpress Basic, but it is the customer's responsibility to send the tool for calibration.

Purchased a new product?

Send the Product registration form to Elpress and Elpress Basic is included for free the first year.



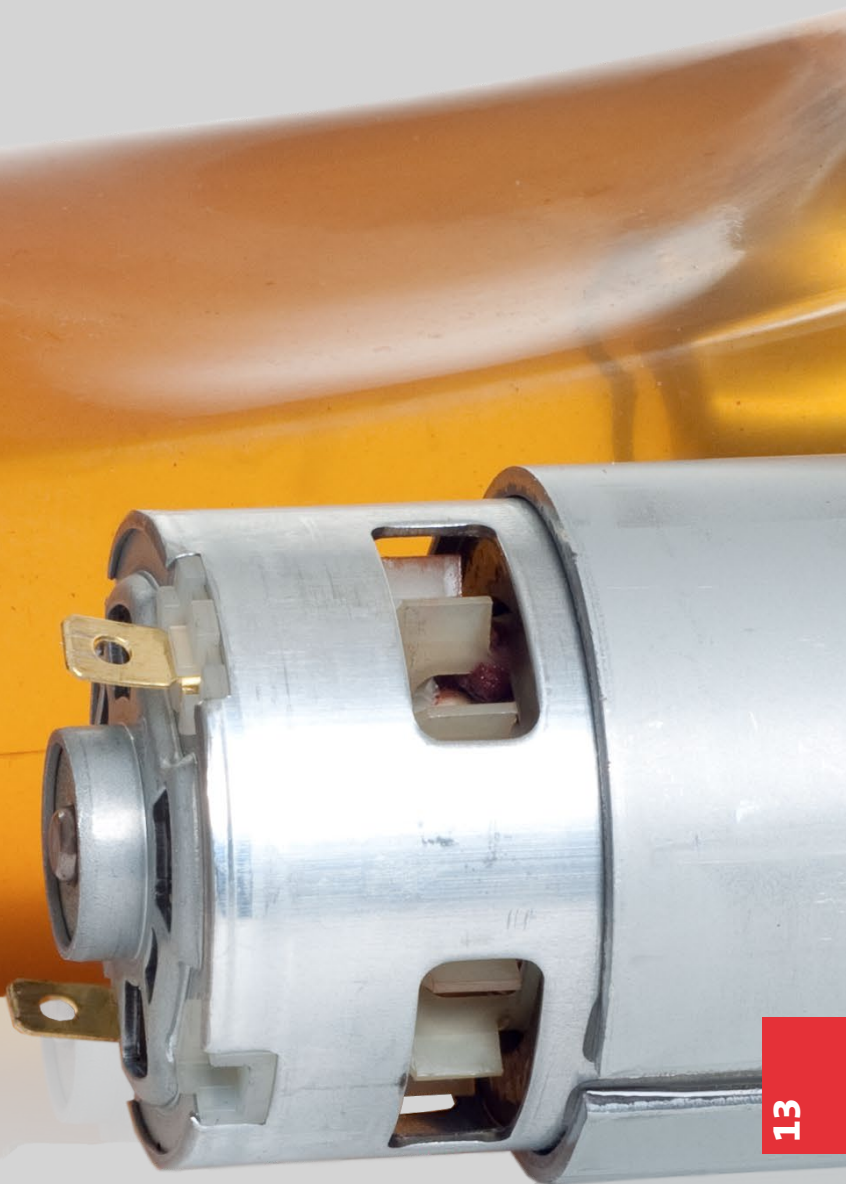

Table of content

Name	Page	Name	Page	Name	Page	Name	Page
1006	7:2	13CB30	6:36	408-6-F	3:17	A0853R	1:4
1009	7:2	13CB30	6:37	408-6-M	3:17	A1,5-10ET	2:4
12523	3:13	13CB32	6:35	408-8-F	3:17	A1,5-10ETD	2:6
12610	3:14	13CB32	6:36	408-8-M	3:17	A1,5-10ETT	2:5
17127	3:13	13CB32	6:37	A0,14-6ET	2:4	A1,5-12ET	2:4
17128	3:13	13CB7	6:37	A0,14-6ETD	2:6	A1,5-12ET2	2:8
1010AL	7:2	13CB8	6:35	A0,14-6ETT	2:5	A1,5-12ETD	2:6
1014AL	7:2	13CB8	6:36	A0,14-8ET	2:4	A1,5-12ETT	2:5
13B10	6:25	13CB8,5	6:37	A0,14-8ETD	2:6	A1,5-12ETT2	2:9
13B11	6:23	13CB9	6:35	A0,14-8ETT	2:5	A1,5-12ETW2	2:10
13B11	6:24	13CB9	6:36	A0,25-6ET	2:4	A1,5-18ET	2:4
13B12	6:24	13CBC13	6:37	A0,25-6ETT	2:5	A1,5-18ETD	2:6
13B12	6:25	13CBC15	6:37	A0,25-8ET	2:4	A1,5-18ETT	2:5
13B13	6:23	13DB11	6:18	A0,25-8ETD	2:6	A1,5-6ET	2:4
13B14	6:24	13DB13	6:18	A0,25-8ETT	2:5	A1,5-6ETD	2:6
13B14	6:25	13DB14,5	6:18	A0,34-6ET	2:4	A1,5-6ETT	2:5
13B14,5	6:23	13DB17	6:18	A0,34-6ETD	2:6	A1,5-8ET	2:4
13B16	6:24	13DB20	6:18	A0,34-6ETT	2:5	A1,5-8ET2	2:8
13B16	6:25	13DB22	6:18	A0,34-8ET	2:4	A1,5-8ETD	2:6
13B17	6:23	13DB25	6:18	A0,34-8ETD	2:6	A1,5-8ETT	2:5
13B18	6:25	13DB27	6:18	A0,34-8ETT	2:5	A1,5-8ETT2	2:9
13B19	6:24	13DB30	6:18	A0,5-10ET	2:4	A1,5-8ETW2	2:10
13B19	6:25	13DB32	6:18	A0,5-10ETD	2:6	A10-12ET	2:4
13B20	6:23	13DB8	6:18	A0,5-10ETT	2:5	A10-12ETD	2:6
13B22	6:23	13DB9	6:18	A0,5-6ET	2:4	A10-12ETT	2:5
13B22	6:24	13DCB11	6:18	A0,5-6ET2	2:8	A10-14ET2	2:8
13B22	6:25	13DCB11	6:49	A0,5-6ETD	2:6	A10-14ETT2	2:9
13B24	6:25	13DCB13	6:18	A0,5-6ETT	2:5	A10-14ETW2	2:10
13B25	6:23	13DCB13	6:49	A0,5-6ETT2	2:9	A10-18ET	2:4
13B25	6:24	13DCB14,5	6:18	A0,5-6ETW2	2:10	A10-18ETD	2:6
13B26	7:9	13DCB14,5	6:49	A0,5-8ET	2:4	A10-18ETT	2:5
13B26	6:25	13DCB17	6:18	A0,5-8ET2	2:8	A1-10ET	2:4
13B26	6:31	13DCB17	6:49	A0,5-8ETD	2:6	A1-10ET2	2:8
13B27	6:23	13DCB20	6:18	A0,5-8ETT	2:5	A1-10ETD	2:6
13B27	6:24	13DCB20	6:49	A0,5-8ETT2	2:9	A1-10ETT	2:5
13B30	6:23	13DCB22	6:18	A0,5-8ETW2	2:10	A1-10ETT2	2:9
13B30	6:24	13DCB25	6:18	A0,75-10ET	2:4	A1-10ETW2	2:10
13B30	6:25	13DCB27	6:18	A0,75-10ET2	2:8	A1-12ET	2:4
13B32	7:9	13DCB30	6:18	A0,75-10ETD	2:6	A1-12ET2	2:8
13B32	6:23	13DCB32	6:18	A0,75-10ETT	2:5	A1-12ETD	2:6
13B32	6:24	13DCB8	6:18	A0,75-10ETT2	2:9	A1-12ETT	2:5
13B32	6:25	13DCB8	6:49	A0,75-10ETW2	2:10	A1-12ETT2	2:9
13B32	6:31	13DCB9	6:18	A0,75-12ET	2:4	A1-12ETW2	2:10
13B38	6:23	13DCB9	6:49	A0,75-12ET2	2:8	A1503FLS5	1:9
13B8	6:23	13P120150D	6:29	A0,75-12ETD	2:6	A1503FLS8	1:9
13B8	6:24	13P120150M	6:29	A0,75-12ETT	2:5	A1503FLSF5	1:10
13B9	6:23	13P185240D	6:29	A0,75-12ETT2	2:9	A1503FLSF8	1:10
13B9	6:24	13P185240M	6:29	A0,75-12ETW2	2:10	A1504HA	1:11
13BC13	6:25	13P32M	6:28	A0,75-6ET	2:4	A1504HO	1:11
13BC15	6:25	13P37D	6:28	A0,75-6ETD	2:6	A1505FLS5	1:9
13C21B38	6:35	13P37M	6:28	A0,75-6ETT	2:5	A1505FLS8	1:9
13CB10	6:37	13P5095D	6:29	A0,75-8ET	2:4	A1505FLSF5	1:10
13CB11	6:35	13P5095M	6:29	A0,75-8ET2	2:8	A1505FLSF8	1:10
13CB11	6:36	13R12DR	6:28	A0,75-8ETD	2:6	A1507FLS	1:9
13CB12	6:36	13R13DR	6:28	A0,75-8ETT	2:5	A1507FLSF	1:10
13CB12	6:37	13R15DR	6:28	A0,75-8ETT2	2:9	A1507FLSH	1:9
13CB13	6:35	13R16DR	6:28	A0,75-8ETW2	2:10	A1507FLST	1:9
13CB14	6:36	13R18DR	6:28	A0503FLS5	1:9	A1507H	1:10
13CB14	6:37	13R18MR	6:28	A0503FLS8	1:9	A1510R	1:4
13CB14,5	6:35	13R20DR	6:28	A0514SR	1:6	A1515PSK	1:8
13CB16	6:36	13R20MR	6:28	A0522R	1:4	A1518SFL	1:7
13CB16	6:37	13R6DR	6:28	A0532G	1:5	A1519SR	1:6
13CB17	6:35	13R7DR	6:28	A0532R	1:4	A1519SRK	1:6
13CB18	6:37	13R8DR	6:28	A0543R	1:4	A1525SK	1:7
13CB19	6:36	13R9DR	6:28	A0553R	1:4	A1529SF	1:7
13CB19	6:37	20DCB22	6:49	A0802HA	1:11	A1529SFN	1:7
13CB20	6:35	20DCB25	6:49	A0802HO	1:11	A1530SFB	1:7
13CB22	6:35	20DCB27	6:49	A0819SR	1:6	A1532G	1:5
13CB22	6:36	20DCB30	6:49	A0819SRK	1:6	A1532R	1:4
13CB22	6:37	20DCB32	6:49	A0824SK	1:7	A1535SKW	1:8
13CB24	6:37	401-12	3:18	A0825SFK	1:7	A1537G	1:5
13CB25	6:35	404-1	3:18	A0832G	1:5	A1537GB	1:5
13CB25	6:36	405-3	3:18	A0832R	1:4	A1537GS	1:5
13CB26	6:37	408-2-F	3:17	A0837G	1:5	A1537R	1:4
13CB27	6:35	408-2-M	3:17	A0837R	1:4	A1543G	1:5
13CB27	6:36	408-4-F	3:17	A0843G	1:5	A1543GB	1:5
13CB30	6:35	408-4-M	3:17	A0843R	1:4	A1543K	1:6

Table of content

Name	Page	Name	Page	Name	Page	Name	Page
A1543R	1:4	A2537GS	1:5	A6-18ETW2	2:10	AKK35-8	5:6
A1553G	1:5	A2537R	1:4	AK1000-1	5:3	AKK400-12	5:6
A1553R	1:4	A2543G	1:5	AK1000-2	5:3	AKK400-16	5:6
A1565G	1:5	A2543GB	1:5	AK1200	5:3	AKK400-20	5:6
A1565R	1:4	A2543K	1:6	AK120-10	5:3	AKK400B-12	5:7
A1585R	1:4	A2543R	1:4	AK120-12	5:3	AKK400B-16	5:7
A16-12ET	2:4	A2553G	1:5	AK150-10	5:3	AKK500A-1	5:6
A16-12ETD	2:6	A2553GB	1:5	AK150-12	5:3	AKK500A-16	5:6
A16-12ETT	2:5	A2553R	1:4	AK150-16	5:3	AKK500A-2	5:6
A16-18ET	2:4	A2565G	1:5	AK16-6	5:3	AKK500A-20	5:6
A16-18ETD	2:6	A2565R	1:4	AK16-8	5:3	AKK500B-1	5:6
A16-18ETT	2:5	A2585R	1:4	AK185-10	5:3	AKK500B-16	5:6
A1-6ET	2:4	A35-16ET	2:4	AK185-12	5:3	AKK500B-2	5:6
A1-6ETD	2:6	A35-16ETD	2:6	AK185-16	5:3	AKK500B-20	5:6
A1-6ETT	2:5	A35-16ETT	2:5	AK240-12	5:3	AKK50-10	5:6
A1-8ET	2:4	A35-18ET	2:4	AK240-16	5:3	AKK50-12	5:6
A1-8ET2	2:8	A35-18ETD	2:6	AK25-6	5:3	AKK50-8	5:6
A1-8ETD	2:6	A35-18ETT	2:5	AK25-8	5:3	AKK630A-1	5:6
A1-8ETT	2:5	A35-25ET	2:4	AK300-12	5:3	AKK630A-2	5:6
A1-8ETT2	2:9	A35-25ETD	2:6	AK300-12SOLID	5:3	AKK70-10	5:6
A1-8ETW2	2:10	A35-25ETT	2:5	AK300-16	5:3	AKK70-12	5:6
A2,08-8ET	2:4	A4-10ET	2:4	AK300-16SOLID	5:3	AKK70-8	5:6
A2,08-8ETD	2:6	A4-10ETD	2:6	AK300-20	5:3	AKK800-1	5:6
A2,08-8ETT	2:5	A4-10ETT	2:5	AK35-6	5:3	AKK800-2	5:6
A2,5-10ET	2:4	A4-12ET	2:4	AK35-8	5:3	AKK95-10	5:6
A2,5-10ET2	2:8	A4-12ET2	2:8	AK400-12	5:3	AKK95-12	5:6
A2,5-10ETD	2:6	A4-12ETD	2:6	AK400-16	5:3	AKK95-16	5:6
A2,5-10ETT	2:5	A4-12ETT	2:5	AK400-20	5:3	AKK95-8	5:6
A2,5-10ETT2	2:9	A4-12ETT2	2:9	AK500A-1	5:3	AKP120	5:7
A2,5-10ETW2	2:10	A4-12ETW2	2:10	AK500A-16	5:3	AKP150	5:7
A2,5-12ET	2:4	A4-18ET	2:4	AK500A-2	5:3	AKP16	5:7
A2,5-12ETD	2:6	A4-18ET2	2:8	AK500A-20	5:3	AKP185	5:7
A2,5-12ETT	2:5	A4-18ETD	2:6	AK500B-1	5:3	AKP240	5:7
A2,5-13ET2	2:8	A4-18ETT	2:5	AK500B-16	5:3	AKP25	5:7
A2,5-13ETT2	2:9	A4-18ETT2	2:9	AK500B-2	5:3	AKP300	5:7
A2,5-13ETW2	2:10	A4-18ETW2	2:10	AK500B-20	5:3	AKP35	5:7
A2,5-18ET	2:4	A4600E	1:11	AK50-10	5:3	AKP50	5:7
A2,5-18ETD	2:6	A4605HA	1:11	AK50-12	5:3	AKP70	5:7
A2,5-18ETT	2:5	A4605HO	1:11	AK50-8	5:3	AKP95	5:7
A2,5-8ET	2:4	A4607FLS	1:9	AK630A-1	5:3	AKS120-120	5:9
A2,5-8ETD	2:6	A4607FLSF	1:10	AK630A-2	5:3	AKS120-50	5:9
A2,5-8ETT	2:5	A4607H	1:10	AK70-10	5:3	AKS120-70	5:9
A2500E	1:11	A4609FLS	1:9	AK70-12	5:3	AKS120-95	5:9
A2505FLS5	1:9	A4610G	1:5	AK70-8	5:3	AKS150-120	5:9
A2505FLS8	1:9	A4610R	1:4	AK800-1	5:3	AKS150-150	5:9
A2505FLSF5	1:10	A4613R	1:4	AK800-2	5:3	AKS150-25	5:9
A2505FLSF8	1:10	A4630SR	1:6	AK95-10	5:3	AKS150-35	5:9
A2505HA	1:11	A4634PSK	1:8	AK95-12	5:3	AKS150-50	5:9
A2505HO	1:11	A4640SF	1:7	AK95-8	5:3	AKS150-70	5:9
A2507FLS	1:9	A4643G	1:5	AKK1000-1	5:6	AKS150-95	5:9
A2507FLSF	1:10	A4643R	1:4	AKK1000-1-16	5:6	AKS16-10	5:9
A2507FLSH	1:9	A4645SFB	1:7	AKK1000-2	5:6	AKS16-10S	5:8
A2507FLST	1:9	A4650SKW	1:8	AKK1200	5:6	AKS1625-1016	5:9
A2507H	1:10	A4652SK	1:7	AKK120-10	5:6	AKS185-120	5:9
A2510R	1:4	A4653G	1:5	AKK120-12	5:6	AKS185-150	5:9
A2513R	1:4	A4653R	1:4	AKK120-16	5:6	AKS185-185	5:9
A25-16ET	2:4	A4665G	1:5	AKK150-10	5:6	AKS185-70	5:9
A25-16ETD	2:6	A4665R	1:4	AKK150-12	5:6	AKS185-95	5:9
A25-16ETT	2:5	A4685G	1:5	AKK150-16	5:6	AKS240-120	5:9
A2517PSK	1:8	A4685R	1:4	AKK16-8	5:6	AKS240-150	5:9
A25-18ET	2:4	A50-20ET	2:4	AKK185-10	5:6	AKS240-185	5:9
A25-18ETD	2:6	A50-20ETD	2:6	AKK185-12	5:6	AKS240-240A	5:9
A25-18ETT	2:5	A50-20ETT	2:5	AKK185-16	5:6	AKS240-35	5:9
A2519SR	1:6	A50-25ET	2:4	AKK240-10	5:6	AKS240-50	5:9
A2519SRK	1:6	A50-25ETD	2:6	AKK240-12	5:6	AKS240-70	5:9
A25-22ET	2:4	A50-25ETT	2:5	AKK240-16	5:6	AKS240-95	5:9
A25-22ETD	2:6	A6-12ET	2:4	AKK25-12	5:6	AKS25-10	5:9
A25-22ETT	2:5	A6-12ETD	2:6	AKK25-8	5:6	AKS25-10S	5:8
A2524SFL	1:7	A6-12ETT	2:5	AKK300-12	5:6	AKS25-16	5:9
A2527SK	1:7	A6-14ET2	2:8	AKK300-12SOLID	5:6	AKS300-150	5:9
A2529SF	1:7	A6-14ETT2	2:9	AKK300-16	5:6	AKS300-185	5:9
A2529SFN	1:7	A6-14ETW2	2:10	AKK300-16SOLID	5:6	AKS300-240A	5:9
A2530SFB	1:7	A6-18ET	2:4	AKK300-20	5:6	AKS300B-185	5:8
A2532G	1:5	A6-18ET2	2:8	AKK300-20SOLID	5:6	AKS300B-240A	5:8
A2532R	1:4	A6-18ETD	2:6	AKK300B-12	5:7	AKS300SOLID-300	5:9
A2535SKW	1:8	A6-18ETT	2:5	AKK300B-16	5:7	AKS35-10	5:9
A2537G	1:5	A6-18ETT2	2:9	AKK35-12	5:6	AKS35-10S	5:8

Table of content

Name	Page	Name	Page	Name	Page	Name	Page
AKS35-16	5:9	B07FLS2H	3:11	B16	6:41	B2532G	3:6
AKS35-25	5:9	B07FLS3H	3:11	B16	6:42	B2532R	3:4
AKS400-150	5:9	B0819SR	3:6	B16-10R	4:14	B2537R	3:4
AKS400-185	5:9	B0832G	3:6	B16-12R	4:14	B2538	6:40
AKS400-240A	5:9	B0832R	3:4	B16-16R	4:14	B2540	6:41
AKS400-300A	5:9	B0843G	3:6	B16-5R	4:14	B2540	6:42
AKS400B-240A	5:8	B0843R	3:4	B16-6R	4:14	B2542	6:40
AKS400B-300A	5:8	B0853R	3:4	B16-8R	4:14	B2543G	3:6
AKS50-10	5:9	B0907H4	3:12	B16NP	7:11	B2543R	3:4
AKS50-10S	5:8	B0907H5	3:12	B16NP	7:11	B2545	6:41
AKS50-16	5:9	B10	6:24	B16NP	7:9	B2545	6:42
AKS50-25	5:9	B10	6:36	B16NP	7:9	B2553	6:40
AKS50-35	5:9	B10	6:42	B16NP	6:31	B2553	6:41
AKS50-50	5:9	B1003FLS5	3:8	B16NP	6:31	B2553	6:42
AKS70-10S	5:8	B1003FLS8	3:8	B16NP	6:46	B2553G	3:6
AKS70-35	5:9	B1003FLSV5	3:9	B16NP	6:46	B2553R	3:4
AKS70-50	5:9	B1003H	3:10	B16SR	4:20	B2565R	3:4
AKS70-70	5:9	B1007HN	3:10	B17	6:22	B25-6R	4:14
AKS95-10	5:9	B10-10R	4:14	B17	6:34	B2585R	3:4
AKS95-10S	5:8	B10-12R	4:14	B17	6:40	B25-8R	4:14
AKS95-16	5:9	B10-5R	4:14	B18	6:24	B25C15	6:43
AKS95-25	5:9	B10-6R	4:14	B18	6:36	B25C18	6:43
AKS95-35	5:9	B10-8R	4:14	B18	6:42	B25C21	6:43
AKS95-50	5:9	B10SR	4:20	B1807H4	3:12	B25SR	4:20
AKS95-70	5:9	B11	6:22	B1807H5	3:12	B26	6:42
AKS95-95	5:9	B11	6:23	B185-12R	4:14	B26NP	7:11
AS1000-1	5:4	B11	6:34	B185-16R	4:14	B26NP	6:46
AS120	5:4	B11	6:35	B19	6:23	B27	6:40
AS1200	5:4	B11	6:40	B19	6:24	B27	6:41
AS120-95	5:5	B11	6:41	B19	6:35	B30	6:40
AS150	5:4	B12	6:23	B19	6:36	B30	6:41
AS150-120	5:5	B12	6:24	B19	6:41	B30	6:42
AS150-50	5:5	B12	6:35	B19	6:42	B35-10R	4:14
AS150-70	5:5	B12	6:36	B20	6:22	B35-12R	4:14
AS150-95	5:5	B12	6:41	B20	6:34	B35-16R	4:14
AS16	5:4	B12	6:42	B20	6:40	B35-6R	4:14
AS1625	5:4	B120-10R	4:14	B20NP	7:11	B35-8R	4:14
AS185	5:4	B120-12R	4:14	B20NP	7:11	B35SR	4:20
AS185-150	5:5	B120-16R	4:14	B20NP	7:9	B4040	6:52
AS185-95	5:5	B13	6:22	B20NP	7:9	B4042	6:52
AS240	5:4	B13	6:34	B20NP	6:31	B4045	6:52
AS240-120	5:5	B13	6:40	B20NP	6:31	B4053	6:52
AS240-150	5:5	B14	6:23	B20NP	6:46	B4056	6:52
AS240-185	5:5	B14	6:24	B20NP	6:46	B40C18	6:52
AS240-95	5:5	B14	6:35	B22	6:22	B40C21	6:52
AS25	5:4	B14	6:36	B22	6:23	B4607FLS1	3:8
AS25-16	5:5	B14	6:41	B22	6:24	B4607FLSN	3:8
AS300	5:4	B14	6:42	B22	6:34	B4607HN	3:10
AS300-240	5:5	B14,5	6:22	B22	6:35	B4610R	3:4
AS300B	5:5	B14,5	6:34	B22	6:36	B4613R	3:4
AS300SOLID	5:4	B14,5	6:40	B22	6:40	B4630SR	3:6
AS35	5:4	B150-12R	4:14	B22	6:41	B4643G	3:6
AS35-25	5:5	B150-16R	4:14	B22	6:42	B4643R	3:4
AS400	5:4	B1502HA	3:10	B24	6:24	B4653G	3:6
AS400-300	5:5	B1502HO	3:10	B24	6:36	B4653R	3:4
AS400B	5:5	B1505FLS5-1	3:8	B24	6:42	B4665R	3:4
AS400SOLID	5:4	B1505FLS8-1	3:8	B2457H4	3:13	B4685R	3:4
AS50	5:4	B1507FLS1	3:8	B2457H5	3:13	B50-10R	4:14
AS500A	5:4	B1507FLSB8	3:9	B25	6:22	B50-12R	4:14
AS500B	5:4	B1507FLSH	3:9	B25	6:34	B50-16R	4:14
AS50-25	5:5	B1507FLSN	3:8	B25	6:40	B50-6R	4:14
AS50-35	5:5	B1507H	3:10	B25	6:41	B50-8R	4:14
AS630A-1	5:4	B1510R	3:4	B2505FLS5	3:8	B50SR	4:20
AS630A-2	5:4	B1519SR	3:6	B2505FLS8	3:8	B6FE	7:11
AS70	5:4	B1532G	3:6	B2507FLS1	3:8	B6FE	7:9
AS70-50	5:5	B1532R	3:4	B2507FLSH	3:9	B6FE	6:31
AS800-1	5:4	B1537GS	3:6	B2507FLSN	3:8	B6FE	6:46
AS95	5:4	B1543G	3:6	B2507H	3:10	B7	6:24
AS95-25	5:5	B1543R	3:4	B2507HN	3:10	B7	6:36
AS95-35	5:5	B1553G	3:6	B2510R	3:4	B7	6:42
AS95-50	5:5	B1553R	3:4	B25-10R	4:14	B70-10R	4:14
AS95-70	5:5	B1565R	3:4	B25-12R	4:14	B70-12R	4:14
B0457H4	3:12	B1585R	3:4	B25-16R	4:14	B70-16R	4:14
B0457H5	3:12	B16	6:23	B2519SR	3:6	B70-8R	4:14
B0502HA	3:10	B16	6:24	B2532	6:40	B70SR	4:20
B0502HO	3:10	B16	6:35	B2532	6:41	B8	6:22
B07FLS1H	3:11	B16	6:36	B2532	6:42	B8	6:23

Table of content

Name	Page	Name	Page	Name	Page	Name	Page
B8	6:34	EMBLA RA S	10:3	ISO1003FL1	3:15	KR6-6	3:5
B8	6:35	EMBLA RA V	10:3	ISO1005FL1	3:15	KR6-6	4:4
B8	6:40	EMBLA S	10:3	ISO1507FLB	3:16	KR6-8	3:5
B8	6:41	EMBLA SP 16-CASSETTE	10:4	ISO1507FLS	3:16	KR6-8	4:4
B8,5	6:24	EMBLA SP S-CASSETTE	10:4	ISO1507HBW6	3:15	KRD1000-00	4:12
B8,5	6:36	EMBLA SP V-CASSETTE	10:4	ISO2507FLS1	3:16	KRD1000-20	4:12
B8,5	6:42	EMBLA V	10:3	K10T	7:2	KRD1000-24	4:12
B8FE	7:11	EMBLA16	10:3	K16	7:2	KRD120-00	4:11
B8FE	7:9	ES2258	6:3	K25	7:2	KRD120-10	4:11
B8FE	6:31	ES2288	6:4	K35	7:2	KRD120-12	4:11
B8FE	6:46	ESAQ0760	1:15	KB0325	1:19	KRD120-14	4:11
B9	6:22	EW1025	6:4	KB0325	2:19	KRD120-16	4:11
B9	6:23	FBS1722	10:9	KB0325	3:25	KRD120-20	4:11
B9	6:34	FBS1722RS	10:9	KB22	6:11	KRD120-8	4:11
B9	6:35	FBS1722SP	10:10	KB22	6:11	KRD150-00	4:11
B9	6:40	FBS1722SP	10:9	KB22	6:12	KRD150-10	4:11
B9	6:41	FBS1723	10:10	KB24	6:12	KRD150-12	4:11
B95-10R	4:14	FBS1723RS	10:10	KB25	6:11	KRD150-14	4:11
B95-12R	4:14	FCU-PS710D&E	6:57	KB25	6:11	KRD150-16	4:11
B95-16R	4:14	FCU-PS710R	6:57	KB26	6:12	KRD150-20	4:11
B95SR	4:20	FS11	11:4	KHS-AKS1025-4	9:3	KRD150-8	4:11
B9953G	3:6	FS12	11:4	KHS-AKS1025-5	9:3	KRD16-10	4:11
B9965G	3:6	FS21	11:4	KHS-AS120150-1-4	9:3	KRD16-12	4:11
BÄRREM PS710	6:57	FS31	11:4	KHS-AS1625-4	9:3	KRD16-5	4:11
BC13	6:43	FS41	11:6	KHS-AS1625-5	9:3	KRD16-6	4:11
BC5	6:25	FS61	11:6	KHS-AS185240-1-4	9:3	KRD16-8	4:11
BC5	6:37	FS62C	11:6	KHS-AS5095-1-4	9:3	KRD185-00	4:11
BC5	6:43	FS71C	11:7	KL2585	10:12	KRD185-10	4:11
BC6	6:25	FS72C	11:7	KL40	10:13	KRD185-12	4:11
BC6	6:37	FS73C	11:7	KL55	10:13	KRD185-14	4:11
BC6	6:43	FS74C	11:7	KL85	10:13	KRD185-16	4:11
BC8-9	6:25	FS77C	11:7	KR0,75-3	3:5	KRD185-20	4:11
BC8-9	6:37	FS81C	11:7	KR0,75-3	4:4	KRD185-8	4:11
BC8-9	6:43	FS81D	11:7	KR0,75-4	3:5	KRD240-00	4:11
C150-185	4:21	FS83C	11:7	KR0,75-4	4:4	KRD240-10	4:11
C16-25	4:21	FS85C	11:7	KR1,5-3	3:5	KRD240-12	4:11
C23	4:21	FS88C	11:7	KR1,5-3	4:4	KRD240-16	4:11
C240-300	4:21	FSHD11	11:5	KR1,5-4	3:5	KRD240-20	4:11
C25-50	4:21	FSHD23	11:5	KR1,5-4	4:4	KRD25-00	4:11
C50-70	4:21	FSHD31	11:5	KR1,5-5	3:5	KRD25-10	4:11
C6-10	4:21	FSHD62C	11:6	KR1,5-5	4:4	KRD25-12	4:11
C70-95	4:21	GEB1025	2:16	KR10-10	3:5	KRD25-6	4:11
C95-120	4:21	GEB1025C	2:16	KR10-10	4:4	KRD25-8	4:11
CS2500	6:48	GEB3550	2:17	KR10-12	3:5	KRD300-00	4:12
CT10	10:6	GEB3550C	2:17	KR10-12	4:4	KRD300-10	4:12
CT20	10:6	GEB4010C	2:16	KR10-4	3:5	KRD300-12	4:12
CUT10	4:19	GEB4010C-TWIN	2:15	KR10-4	4:4	KRD300-14	4:12
CUT16	4:19	GRB0560	3:23	KR10-5	3:5	KRD300-16	4:12
CUT6	4:19	GRB0560C	3:23	KR10-5	4:4	KRD300-20	4:12
DB2522	6:19	GRB0560L	3:22	KR10-6	3:5	KRD300-24	4:12
DB2525	6:19	GRB0560LC	3:22	KR10-6	4:4	KRD35-00	4:11
DB2527	6:19	GSA0760	1:17	KR10-6-45GR	4:8	KRD35-10	4:11
DB2530	6:19	GSA0760C	1:17	KR10-6-90GR	4:9	KRD35-12	4:11
DB2532	6:19	GSEA0340C	1:16	KR10-8	3:5	KRD35-14	4:11
DB2538	6:19	GSEA0340C	2:14	KR10-8	4:4	KRD35-16	4:11
DKB0325	3:20	GSW0560C	1:16	KR10-8-45GR	4:8	KRD35-6	4:11
DKB0760	3:21	GWB4010	3:23	KR10-8-90GR	4:9	KRD35-8	4:11
DRB0115	3:20	GWB4010C	3:23	KR2,5-3	3:5	KRD400-00	4:12
DSA0115	1:15	GWB4099	3:23	KR2,5-3	4:4	KRD400-12	4:12
DSA0725	1:15	GWB4099C	3:23	KR2,5-4	3:5	KRD400-14	4:12
DV1300	6:16	HB150	1:13	KR2,5-4	4:4	KRD400-16	4:12
DV1300C2	6:16	HKL40	10:13	KR2,5-5	3:5	KRD400-20	4:12
DV250	6:17	HKL55	10:13	KR2,5-5	4:4	KRD400-24	4:12
EB0560	1:19	HKL85	10:13	KR2,5-6	3:5	KRD500-00	4:12
EB0560	2:19	HKS34	10:7	KR2,5-6	4:4	KRD500-12	4:12
EB0560	3:25	HKS35F	10:8	KR4-3	3:5	KRD500-14	4:12
EB1025	1:19	HKS50	10:7	KR4-3	4:4	KRD500-16	4:12
EB1025	2:19	HKS60F	10:8	KR4-4	3:5	KRD500-20	4:12
EB1025	3:25	HKS62	10:8	KR4-4	4:4	KRD500-24	4:12
EB3550	1:19	HKS80	10:8	KR4-5	3:5	KRD50-10	4:11
EB3550	2:19	HYD.SLANG KPL. 2,4M ERG PS710E	6:57	KR4-5	4:4	KRD50-12	4:11
EB3550	3:25	HYD.SLANG KPL. 2,4M ERGOCOM	6:57	KR4-6	3:5	KRD50-16	4:11
EB4010	1:19	HYD.SLANG KPL. 5M ERGO PS710E	6:57	KR4-6	4:4	KRD50-6	4:11
EB4010	2:19	HYD.SLANG KPL. 5M ERGO PS710R	6:57	KR6-4	3:5	KRD50-8	4:11
EB4010	3:25	HYD.SLANG KPL. 5M ERGOCOM	6:57	KR6-4	4:4	KRD630-00	4:12
EL2258	6:3	HYD.SLANG KPL.2,4M ERGO PS710R	6:57	KR6-5	3:5	KRD630-12	4:12
EMBLA RA 16	10:3	ISL2201	8:5	KR6-5	4:4	KRD630-16	4:12

Table of content

Name	Page	Name	Page	Name	Page	Name	Page
KRD630-18	4:12	KRDIN95-16	4:13	KRF300A-12X2-40	4:6	KRFS120-8	4:7
KRD630-20	4:12	KRDIN95-8	4:13	KRF300A-16	4:5	KRFS150-10	4:7
KRD630-22	4:12	KRF120-10	4:5	KRF300A-20	4:5	KRFS150-12	4:7
KRD630-24	4:12	KRF120-10-45GR	4:8	KRF300A-24	4:5	KRFS150-6	4:7
KRD70-00	4:11	KRF120-10-90GR	4:9	KRF35-10	4:5	KRFS150-8	4:7
KRD70-10	4:11	KRF120-10-90GR-SB	4:9	KRF35-10-45GR	4:8	KRFS185-10	4:7
KRD70-12	4:11	KRF120-10X2-24-26	4:6	KRF35-10-90GR	4:9	KRFS185-12	4:7
KRD70-16	4:11	KRF120-12	4:5	KRF35-10X2-24-26	4:6	KRFS240A-10	4:7
KRD70-7	4:11	KRF120-12-45GR	4:8	KRF35-10X2-40	4:6	KRFS240A-12	4:7
KRD70-8	4:11	KRF120-12-90GR	4:9	KRF35-12	4:5	KRFS240A-16	4:7
KRD800-00	4:12	KRF120-12-90GR-SB	4:9	KRF35-6	4:5	KRFS300A-10	4:7
KRD800-16	4:12	KRF120-12X2-40	4:6	KRF35-6-45GR	4:8	KRFS300A-12	4:7
KRD800-24	4:12	KRF120-16	4:5	KRF35-6-90GR	4:9	KRFS300A-16	4:7
KRD95-00	4:11	KRF120-16-45GR	4:8	KRF35-8	4:5	KRFS400A-12	4:7
KRD95-10	4:11	KRF120-16-90GR	4:9	KRF35-8-45GR	4:8	KRFS400A-16	4:7
KRD95-12	4:11	KRF120-16-90GR-SB	4:9	KRF35-8-90GR	4:9	KRFS50-10	4:7
KRD95-14	4:11	KRF120-8-90GR	4:9	KRF400A-00	4:5	KRFS50-6	4:7
KRD95-16	4:11	KRF120-8-90GR-SB	4:9	KRF400A-12	4:5	KRFS50-8	4:7
KRD95-6	4:11	KRF150-10	4:5	KRF400A-12X2-40	4:6	KRFS70-10	4:7
KRD95-8	4:11	KRF150-10-45GR	4:8	KRF400A-16	4:5	KRFS70-6	4:7
KRDIN1000-20	4:13	KRF150-10-90GR	4:9	KRF400A-20	4:5	KRFS70-8	4:7
KRDIN10-10	4:13	KRF150-10-90GR-SB	4:9	KRF400A-24	4:5	KRFS95-10	4:7
KRDIN10-5	4:13	KRF150-10X2-24-26	4:6	KRF500-00	4:5	KRFS95-12	4:7
KRDIN10-6	4:13	KRF150-12	4:5	KRF500-12	4:5	KRFS95-6	4:7
KRDIN10-8	4:13	KRF150-12-45GR	4:8	KRF500-14	4:5	KRFS95-8	4:7
KRDIN120-10	4:13	KRF150-12-90GR	4:9	KRF500-16	4:5	KRT10-10	4:10
KRDIN120-12	4:13	KRF150-12-90GR-SB	4:9	KRF500-20	4:5	KRT10-12	4:10
KRDIN120-16	4:13	KRF150-12X2-40	4:6	KRF500-24	4:5	KRT10-5	4:10
KRDIN120-20	4:13	KRF150-16	4:5	KRF50-10	4:5	KRT10-6	4:10
KRDIN150-10	4:13	KRF150-16-45GR	4:8	KRF50-10-45GR	4:8	KRT10-8	4:10
KRDIN150-12	4:13	KRF150-16-90GR-LB	4:9	KRF50-10-90GR	4:9	KRT120-10	4:10
KRDIN150-16	4:13	KRF150-16-90GR-SB	4:9	KRF50-10X2-24-26	4:6	KRT120-12	4:10
KRDIN150-20	4:13	KRF150-20	4:5	KRF50-10X2-40	4:6	KRT120-16	4:10
KRDIN16-10	4:13	KRF16-10	4:5	KRF50-12	4:5	KRT120-8	4:10
KRDIN16-12	4:13	KRF16-10-45GR	4:8	KRF50-12-45GR	4:8	KRT150-10	4:10
KRDIN16-6	4:13	KRF16-10X2-24-26	4:6	KRF50-12-90GR	4:9	KRT150-12	4:10
KRDIN16-8	4:13	KRF16-10X2-40	4:6	KRF50-16	4:5	KRT150-16	4:10
KRDIN185-10	4:13	KRF16-12	4:5	KRF50-6	4:5	KRT150-20	4:10
KRDIN185-12	4:13	KRF16-6	4:5	KRF50-8	4:5	KRT16-10	4:10
KRDIN185-16	4:13	KRF16-6-45GR	4:8	KRF50-8-45GR	4:8	KRT16-12	4:10
KRDIN185-20	4:13	KRF16-6-90GR	4:9	KRF50-8-90GR	4:9	KRT16-5	4:10
KRDIN240-10	4:13	KRF16-6X2-16	4:6	KRF630-00	4:5	KRT16-6	4:10
KRDIN240-12	4:13	KRF16-8	4:5	KRF630-12	4:5	KRT16-8	4:10
KRDIN240-16	4:13	KRF16-8-45GR	4:8	KRF630-16	4:5	KRT185-10	4:10
KRDIN240-20	4:13	KRF16-8-90GR	4:9	KRF630-20	4:5	KRT185-12	4:10
KRDIN25-10	4:13	KRF185-10	4:5	KRF630-24	4:5	KRT185-16	4:10
KRDIN25-12	4:13	KRF185-10-90GR-SB	4:9	KRF70-10	4:5	KRT185-20	4:10
KRDIN25-6	4:13	KRF185-10X2-24-26	4:6	KRF70-10-45GR	4:8	KRT240-10	4:10
KRDIN25-8	4:13	KRF185-12	4:5	KRF70-10-90GR	4:9	KRT240-12	4:10
KRDIN300-12	4:13	KRF185-12-90GR-SB	4:9	KRF70-10X2-24-26	4:6	KRT240-16	4:10
KRDIN300-16	4:13	KRF185-12X2-40	4:6	KRF70-12	4:5	KRT240-20	4:10
KRDIN300-20	4:13	KRF185-16	4:5	KRF70-12-45GR	4:8	KRT25-10	4:10
KRDIN35-10	4:13	KRF185-16-90GR-SB	4:9	KRF70-12-90GR	4:9	KRT25-12	4:10
KRDIN35-12	4:13	KRF185-20	4:5	KRF70-12X2-40	4:6	KRT25-16	4:10
KRDIN35-6	4:13	KRF240A-10	4:5	KRF70-16	4:5	KRT25-5	4:10
KRDIN35-8	4:13	KRF240A-10X2-24-26	4:6	KRF70-6	4:5	KRT25-6	4:10
KRDIN400-12	4:13		4:6	KRF70-8	4:5	KRT25-8	4:10
KRDIN400-16	4:13	KRF240A-12	4:5	KRF70-8-45GR	4:8	KRT300-10	4:10
KRDIN400-20	4:13	KRF240A-12X2-40	4:6	KRF70-8-90GR	4:9	KRT300-12	4:10
KRDIN500-20	4:13	KRF240A-16	4:5	KRF800-00	4:5	KRT300-16	4:10
KRDIN50-10	4:13	KRF240A-20	4:5	KRF800-16	4:5	KRT300-20	4:10
KRDIN50-12	4:13	KRF25-10	4:5	KRF800-24	4:5	KRT300-24	4:10
KRDIN50-16	4:13	KRF25-10-45GR	4:8	KRF95-10	4:5	KRT35-10	4:10
KRDIN50-6	4:13	KRF25-10-90GR	4:9	KRF95-10-45GR	4:8	KRT35-12	4:10
KRDIN50-8	4:13	KRF25-10X2-40	4:6	KRF95-10-90GR	4:9	KRT35-16	4:10
KRDIN625-20	4:13	KRF25-12	4:5	KRF95-10X2-24-26	4:6	KRT35-6	4:10
KRDIN6-5	4:13	KRF25-14X2-40	4:6	KRF95-12	4:5	KRT35-8	4:10
KRDIN6-6	4:13	KRF25-6	4:5	KRF95-12-45GR	4:8	KRT400-12	4:10
KRDIN6-8	4:13	KRF25-6-45GR	4:8	KRF95-12-90GR	4:9	KRT400-16	4:10
KRDIN70-10	4:13	KRF25-6-90GR	4:9	KRF95-12X2-40	4:6	KRT400-20	4:10
KRDIN70-12	4:13	KRF25-6X2-16	4:6	KRF95-16	4:5	KRT400-24	4:10
KRDIN70-16	4:13	KRF25-8	4:5	KRF95-16-45GR	4:8	KRT500-12	4:10
KRDIN70-6	4:13	KRF25-8-45GR	4:8	KRF95-16-90GR	4:9	KRT500-14	4:10
KRDIN70-8	4:13	KRF25-8-90GR	4:9	KRF95-8	4:5	KRT500-16	4:10
KRDIN800-20	4:13	KRF25-8X2-40	4:6	KRFS120-10	4:7	KRT500-20	4:10
KRDIN95-10	4:13	KRF300A-10	4:5	KRFS120-12	4:7	KRT50-10	4:10
KRDIN95-12	4:13	KRF300A-12	4:5	KRFS120-6	4:7	KRT50-12	4:10

Table of content

Name	Page	Name	Page	Name	Page	Name	Page
KRT50-16	4:10	KSF16	4:15	MBC6	6:7	PS710R500-US	6:56
KRT50-6	4:10	KSF16M	4:16	MC02F	3:17	PVL130P	1:18
KRT50-8	4:10	KSF185	4:15	MC02M	3:17	PVL130P	2:18
KRT70-10	4:10	KSF185M	4:16	MC03F	3:17	PVL130P	3:24
KRT70-12	4:10	KSF240A	4:15	MC03M	3:17	PVL130P-US	1:18
KRT70-16	4:10	KSF240AM	4:16	MC04F	3:17	PVL130P-US	2:18
KRT70-6	4:10	KSF25	4:15	MC04M	3:17	PVL130P-US	3:24
KRT70-8	4:10	KSF25M	4:16	MC06F	3:17	PVL130P-WOBC	1:18
KRT95-10	4:10	KSF300A	4:15	MC06M	3:17	PVL130P-WOBC	2:18
KRT95-12	4:10	KSF300AM	4:16	MC09F	3:17	PVL130P-WOBC	3:24
KRT95-16	4:10	KSF35	4:15	MC09M	3:17	PVL130S	1:19
KRT95-8	4:10	KSF35M	4:16	MC12F	3:17	PVL130S	2:19
KRX10-10	4:20	KSF400A	4:15	MC15F	3:17	PVL130S	3:25
KRX10-12	4:20	KSF400AM	4:16	MC15M	3:17	PVL130S-US	1:19
KRX10-8	4:20	KSF50	4:15	MOBILE	1:20	PVL130S-US	2:19
KRX16-10	4:20	KSF500	4:15	MOBILE	2:20	PVL130S-US	3:25
KRX16-12	4:20	KSF500M	4:16	MOBILE	3:26	PVL130S-WOBC	1:19
KRX16-8	4:20	KSF50M	4:16	MOBILE BOX	1:21	PVL130S-WOBC	2:19
KS0,75	3:7	KSF630	4:15	MOBILE BOX	2:21	PVL130S-WOBC	3:25
KS0,75	4:15	KSF70	4:15	MOBILE BOX	3:27	PVL350	6:6
KS1,5	3:7	KSF70M	4:16	MOBILE DATA/COM	1:20	PVL350-US	6:6
KS1,5	4:15	KSF800	4:15	MOBILE DATA/COM	2:20	PVL350-WOBC	6:6
KS1,5P	4:18	KSF95	4:15	MOBILE DATA/COM	3:26	PVX1300	7:8
KS10	3:7	KSF95M	4:16	MOBILE INSTALLATION	1:20	PVX1300	6:15
KS10	4:15	KST10	4:17	MOBILE INSTALLATION	2:20	PVX1300	6:21
KS10M	4:16	KST120	4:17	MOBILE INSTALLATION	3:26	PVX1300-ADV	7:8
KS10P	4:19	KST150	4:17	MOBILE SOLAR	1:21	PVX1300-ADV	6:15
KS120P	4:19	KST16	4:17	MOBILE SOLAR	3:27	PVX1300-ADV	6:21
KS150P	4:19	KST185	4:17	ODEN	10:5	PVX1300C2	6:17
KS16P	4:19	KST240	4:17	ODEN SP KNIFE	10:5	PVX1300C2	6:33
KS185P	4:19	KST25	4:17	P13D	6:28	PVX1300C2-ADV	6:17
KS2,5	3:7	KST300	4:17	P13D	6:44	PVX1300C2-ADV	6:33
KS2,5	4:15	KST35	4:17	P13M	6:28	PVX1300C2DB	6:17
KS2,5P	4:18	KST400	4:17	P13M	6:44	PVX1300C2DB	6:33
KS240P	4:19	KST50	4:17	P20D	6:28	PVX1300C2DB-ADV	6:17
KS25P	4:19	KST500	4:17	P20D	6:44	PVX1300C2DB-ADV	6:33
KS300P	4:19	KST70	4:17	P20M	6:28	PVX1300C2DB-US	6:17
KS35P	4:19	KST95	4:17	P20M	6:44	PVX1300C2DB-US	6:33
KS4	3:7	KSX10	4:20	P2552D	6:44	PVX1300C2-US	6:17
KS4	4:15	KSX16	4:20	P2552M	6:44	PVX1300C2-US	6:33
KS400P	4:19	L1300 CU-ALU	6:27	P25D	6:28	PVX1300C2-WOBC	6:17
KS500P	4:19	L1300 CU-ALU	6:30	P25D	6:44	PVX1300C2-WOBC	6:33
KS50P	4:19	L-ALU	7:12	P25M	6:28	PVX1300-CASE-ADV	6:26
KS6	3:7	L-ALU	6:30	P25M	6:44	PVX1300DB	7:8
KS6	4:15	L-ALU	6:47	P32D	6:28	PVX1300DB	6:15
KS630P	4:19	LFEAL62	7:3	P32D	6:44	PVX1300DB	6:21
KS6P	4:18	LFEAL99	7:3	P32M	6:44	PVX1300DB-ADV	7:8
KS70P	4:19	LFS157	7:3	P36-40-44D	6:44	PVX1300DB-ADV	6:15
KS95P	4:19	LFS241	7:3	P36-40-44D	6:44	PVX1300DB-ADV	6:21
KSC150N-1-4HS	9:2	LFS31	7:3	P36-40-44D	6:44	PVX1300DB-US	7:8
KSC150N-1-5HS	9:2	LFS62	7:3	P36M	6:44	PVX1300DB-US	6:15
KSC240N-1-4HS	9:2	LFS99	7:3	P4000	6:58	PVX1300DB-US	6:21
KSC240N-1-5HS	9:2	L-PVX1300	6:27	P40M	6:44	PVX1300-US	7:8
KSC50N-1-4HS	9:2	L-PVX1300	6:30	P44M	6:44	PVX1300-US	6:15
KSC50N-1-5HS	9:2	LV1300B	6:27	PCT54C	10:11	PVX1300-US	6:21
KSC95N-1-4HS	9:2	LV250	7:12	PCT54C-US	10:11	PVX1300-WOBC	7:8
KSC95N-1-5HS	9:2	LV250	6:47	PCT54C-WOBC	10:11	PVX1300-WOBC	6:15
KSD1000	4:18	MB10	6:8	PEB0110T	2:13	PVX1300-WOBC	6:21
KSD120	4:18	MB11	6:7	PEB0110T18	2:13	PVX1300-WOBC-ADV	
KSD150	4:18	MB11	6:8	PEB0116H	2:13		7:8
KSD16	4:18	MB12	6:8	PEB0116S	2:13	PVX1300-WOBC-ADV	
KSD185	4:18	MB12	6:8	PL1001	1:12		6:15
KSD240	4:18	MB13	6:7	PL450	1:13	PVX1300-WOBC-ADV	
KSD25	4:18	MB14	6:8	PL451M	1:12		6:21
KSD300	4:18	MB14	6:8	PL701	3:18	PVX611	7:5
KSD35	4:18	MB14,5	6:7	PL800ET-PEB0116H	2:11	PVX611	6:10
KSD400	4:18	MB16	6:8	PL800ET-PEB0116S	2:11	PVX611DB	7:5
KSD50	4:18	MB17	6:7	PS710D	6:54	PVX611DB	6:10
KSD500	4:18	MB17	6:8	PS710E	6:55	PVX611-US	7:5
KSD630	4:18	MB4016	6:7	PS710E251	6:55	PVX611-US	6:10
KSD70	4:18	MB7	6:8	PS710E251-US	6:55	PVX611-WOBC	7:5
KSD800	4:18	MB8	6:7	PS710E501	6:55	PVX611-WOBC	6:10
KSD95	4:18	MB8	6:8	PS710E501-US	6:55	PZD3	2:15
KSF120	4:15	MB8,5	6:8	PS710R	6:56	R12DR	6:45
KSF120M	4:16	MB9	6:7	PS710R250	6:56	R12MR	6:28
KSF150	4:15	MB9	6:8	PS710R250-US	6:56	R12MR	6:45
KSF150M	4:16	MBC5	6:7	PS710R500	6:56	R13DR	6:45

Table of content

Name	Page	Name	Page	Name	Page
R13MR	6:28	T2600B	6:10	V2531	6:45
R13MR	6:45	T2600C	7:5	V2531	6:45
R15DR	6:45	T2600C	6:10	V2540	6:45
R15MR	6:28	T3165A1	6:5	V600	7:4
R15MR	6:45	T3165B	6:5	V600	6:9
R16DR	6:45	T3165C	6:5	V611	7:4
R16MR	6:28	T50	1:14	V611	6:9
R16MR	6:45	T50	3:19	W60D	6:53
R18DR	6:45	T51	1:14	W60M	6:53
R18MR	6:45	T51	3:19	W70D	6:53
R20DR	6:45	T52	1:14	W70M	6:53
R20MR	6:45	T52	3:19	WB4099	1:19
R21DR	6:45	TB10-16	6:12	WB4099	2:19
R21MR	6:45	TB11-14,5	6:11	WB4099	3:25
R26DR	6:45	TB11-16	6:11		
R26MR	6:45	TB12-14	6:12		
R28DR	6:45	TB7-19	6:12		
R28MR	6:45	TB7-20	6:11		
R6DR	6:45	TB8,5-18	6:12		
R6MR	6:28	TB8-14	6:11		
R6MR	6:45	TB8-17	6:11		
R7DR	6:45	TB9-12	6:11		
R7MR	6:28	TB9-13	6:11		
R7MR	6:45	TBC5-C6	6:13		
R8DR	6:45	TBC89-B13	6:13		
R8MR	6:28	TBKA9-11,5	6:14		
R8MR	6:45	TBNP16-20	7:6		
R9DR	6:45	TBNP16-20	6:12		
R9MR	6:28	TH0650T	6:5		
R9MR	6:45	TH10120T	6:5		
RB0560	1:19	TOR	10:5		
RB0560	2:19	TOR SP BIG HOOK	10:5		
RB0560	3:25	TOR SP KNIFE	10:5		
RPL5548	2:12	TOR SP SMALL HOOK	10:5		
RPL605	1:12	TP13D	6:14		
SA0760	1:19	TP13M	6:14		
SA0760	2:19	TRB0515B	3:20		
SA0760	3:25	TS1300	6:33		
SBC50	8:5	TS1300AL	6:33		
SC150N	8:3	TS1300CU	6:33		
SC150N/PEN	8:4	TV2620	6:14		
SC150R95S	8:3	UFE	10:7		
SC240/PEN	8:4	UFE1	10:7		
SC240N	8:3	UFE2	10:7		
SC240R185S	8:3	UFEB	10:7		
SC400R240S	8:3	UP-B41	10:6		
SC50R50S	8:3	V1300	7:7		
SC630R	8:3	V1300	6:20		
SC95N	8:3	V1300C2	6:32		
SC95N/PEN	8:4	V1311-A	7:7		
SC95R95S	8:3	V1311-A	6:20		
SCT001	10:6	V1311C2-A	6:32		
SD0525	2:12	V1316	6:26		
SD4016	2:12	V1318	6:26		
SL150R95S-10-12	8:5	V1320	6:29		
SL150R95S-12X2-40	8:5	V1330	6:38		
SL240N-10-12	8:4	V1470	6:51		
SL240R-12-16	8:4	V250	7:10		
SL240R-12X2-40	8:4	V250	6:39		
SL240R185S-12-16	8:5	V2506	6:43		
SL400R-12X2-40	8:4	V2508	6:43		
SL400R240S-00	8:5	V2521	6:44		
SL400R240S-16	8:5	V2521	6:44		
SL400R240S-20	8:5	V2521	6:44		
SL500B-630B-12X2-40	8:5	V2521	6:45		
SL50N-10-12	8:4	V2521	6:45		
SL630B-12X2-40	8:4	V2521	6:45		
SL630R-1	8:5	V2521	6:45		
SL630R-12X2-40	8:5	V2521	6:45		
SL630R-14	8:5	V2521	6:45		
SL630R-16	8:5	V2521	6:45		
SL70R70S-10-12	8:5	V2521	6:45		
SL95N-10-12	8:4	V2521	6:45		
T2258	6:3	V2531	6:44		
T2600	7:5	V2531	6:44		
T2600	6:10	V2531	6:44		
T2600B	7:5	V2531	6:44		

Europe

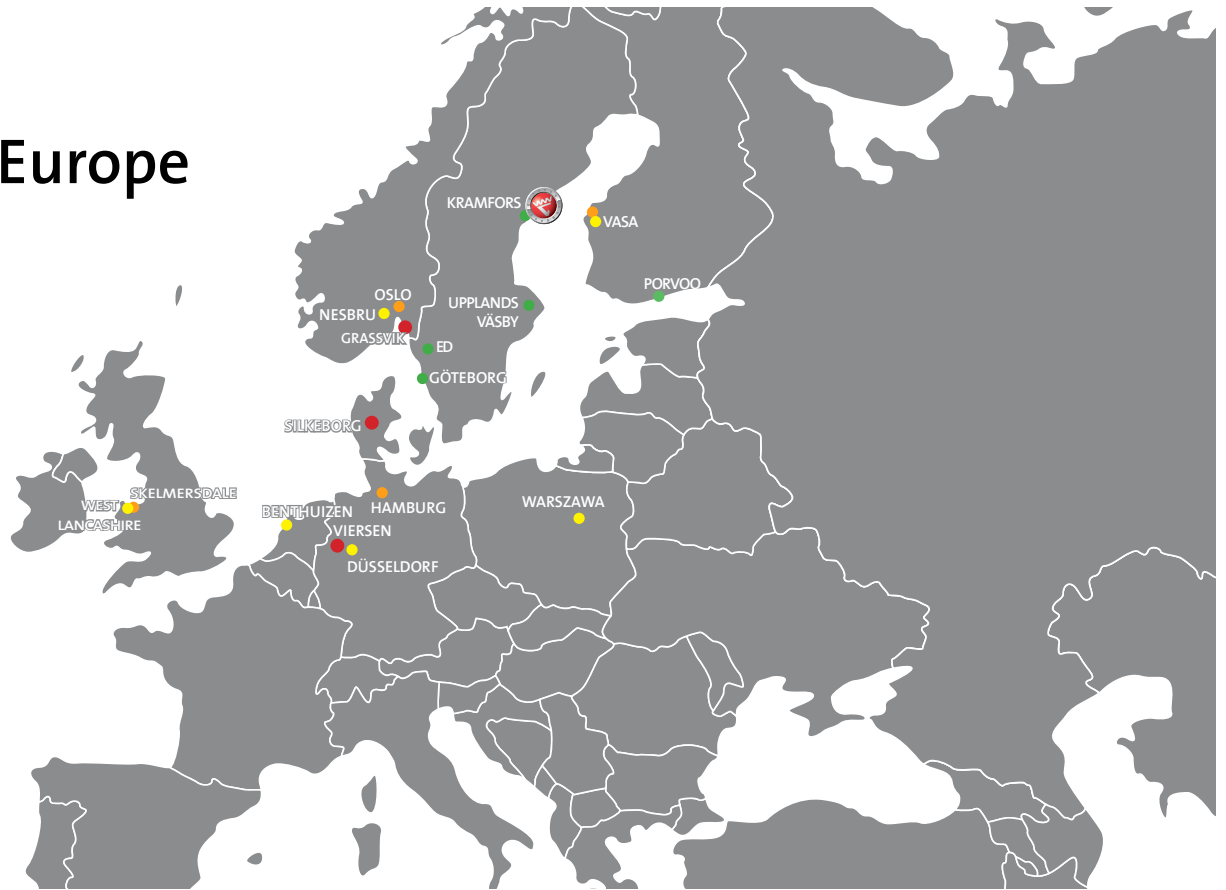

USA



Asia



Head office and production

Elpress AB, Kramfors Sweden

Subsidiaries

- Elpress AS, Gressvik Norway
- Elpress A/S, Silkeborg Denmark
- Elpress GmbH, Viersen Germany
- Elpress China, Beijing China
- Elpress Inc, Chicago USA

Sales

- Region north Sweden, Kramfors
- Region middle Sweden, Upplands Väsby
- Region south Sweden, Gothenburg
- Sales office, Ed
- Suomi, Porvoo
- India, New Delhi



Service partners

- Hydraulikkteknikk, Hagan (Oslo) Norway
- Enkom, Vasa Suomi
- Hamburger Hochdruck Hydraulik, Hamburg Germany
- E-Tech Components, Skelmersdale UK
- Precision Hydraulics, Portland USA



Distributors and partners

- Unitronic GmbH, Düsseldorf Germany
- Enkom-Active Oy, Helsingby Soumi
- JF Knudtzen AS, Nesbru Norway
- Jobarco, Br Benthuiizen Netherlands
- ACTE Sp. Z o.o., Warszawa Polen
- E-Tech Components, West Lancashire UK



ELPRESS

